

# Applications For Pass. Cars, Light Trucks, SUV's, & Vans

VEHICLE MAKE, MODEL & YEAR	<b>GR-2</b>		<b>Gas-a-Just</b>		<b>MonoMax</b> 56XXXX Series		STRUT & SHOCK			
MARQUE, MODELE ET	<b>Excel-G</b>				<b>AGX</b>		MOUNTS		BOOT KITS	
ANNEE DU VEHICULE					7XXXXX Series					
LA MARCA EL MODELO & AÑO										

## ACURA CL

2001-03	ALL		341257	341258			741049	741050	SM5058 SM5207	SM5059	SB108	SB107
1997-99	ALL	Right Hand	341117	341119			741010	741012	SM5058	SM5059	SB108	SB108
		Left Hand	341118	341119			741011	741012	SM5058 SM5207	SM5059	SB108	SB108
		Control Arm Bushing (Strut to Arm)								SM5051		
		Knuckle Shock Bushing								SM5515		
		Mount Plate w/ Insulator										
		Upper Spring Seat Insulator							SM5514 SM5486			

## ACURA CSX

2006-10	ALL									SM5404	SB101	
		Lower Shock Bushing										

## ACURA EL (Canadian Vehicle)

2002-03	ALL	Right Hand	331008	341311			731003	741060	SM5402	SM5400	SB103	SB108
		Left Hand	331009	341311			731004	741060	SM5402	SM5400	SB103	SB108
2001	ALL	Right Hand	331008	341311			731003	741060	SM5403	SM5400	SB103	SB108
		Left Hand	331009	341311			731004	741060	SM5403	SM5400	SB103	SB108
1997-00	ALL		341203	341198			741023	741024	SM5058	SM5058	SB108	SB108

## ACURA Integra

1994-01	Mount Plate w/ Insulator ALL (Exc. TYPE-R)	Right Hand	341138	341094			741005	741007	SM5538	SM5058	SB108	SB108
		Left Hand	341139	341094			741006	741007	SM5058 SM5210	SM5058	SB108	SB108
	Control Arm Bushing (Strut to Arm)									SM5208 SM5516 SM5528		
	Mount Plate w/ Insulator Upper Spring Seat Insulator								SM5527			
1990-93	ALL	Right Hand	341135	341137			741008		SM5058	SM5058	SB108	SB108
		Left Hand	341136	341137			741009		SM5058 SM5210	SM5058	SB108	SB108
	Control Arm Bushing Control Arm Bushing (Strut to Arm)									SM5166		
1986-89	ALL		234027	341050 <sup>2</sup>					SM5293	SM5059	SB103	

## ACURA Legend

1991-95	Sedan & Coupe	Right Hand	344606	344608					SM5191	SM5192	SB101	SB107
		Left Hand	344607	344608					SM5191	SM5192 SM5224	SB101	SB107
1989-90	Sedan	Right Hand	341112	341116					SM5058	SM5059	SB108	SB107
		Left Hand	341113	341116					SM5058	SM5059 SM5051	SB108	SB107
1986-90	Coupe	Right Hand	341112	341116					SM5058	SM5059	SB108	SB107
		Left Hand	341113	341116					SM5058	SM5059 SM5051	SB108	SB107
1986-88	Sedan	Right Hand	341112	234044					SM5058	SM5288	SB108	SB107
		Left Hand	341113	234045					SM5058	SM5288	SB108	SB107

## ACURA MDX

2007-09	ALL (Exc. Electronic Adj. Susp.)	Right Hand	339037	349025								
		Left Hand	339038	349025								
2003-06	ALL	Right Hand	339072	349039					SM5211		SB104	
		Left Hand	339073	349039					SM5211		SB104	
2001-02	ALL	Right Hand	334364	344353					SM5211		SB104	
		Left Hand	334365	344353					SM5211		SB104	





<sup>2</sup> The KYB replacement unit comes with a new dustcover/ bumper assembly.

Notes de bas de Page 320 - Guia de notas al calce del catalogo Pg. 321

Bold part numbers indicate the most comparable KYB product to the original design & performance.

(22) For vehicles with Electronic Susp., Leveling Control, and Air Suspensions refer to Appendix C.

# Applications For Pass. Cars, Light Trucks, SUV's, & Vans

VEHICLE MAKE, MODEL & YEAR		<b>GR-2</b> <i>Excel-G</i>		<b>Gas-a-Just</b>		<b>MonoMax</b> 56XXXX Series <b>AGX</b> 7XXXX Series		STRUT & SHOCK MOUNTS		BOOT KITS	
MARQUE, MODELE ET ANNEE DU VEHICULE											
LA MARCA EL MODELO & AÑO											

## ACURA NSX

1991-05	ALL									SB108	SB108
---------	-----	--	--	--	--	--	--	--	--	-------	-------

## ACURA RL

2005-10	ALL									SB108	SB108		
2002-04	ALL	Right Hand	341432	341437						SM5289	SM5290	SB108	SB107
		Left Hand	341433	341437						SM5289	SM5290	SB108	SB107
1996-01	ALL	Right Hand	341434	341437						SM5289	SM5290	SB108	SB107
		Left Hand	341435	341437						SM5289	SM5290	SB108	SB107

## ACURA RDX

2010	AWD			349095								SB102	
2007-09	ALL			349095								SB102	

## ACURA RSX

2005-06	Strut Boot Mount & Bearing (Exc. Type S) Mount & Bearing (Type S) Shock Mount Kit									SM5403		SB104	
										SM5402	SM5400		
2002-04	ALL	Right Hand	331601	341376						SM5403	SM5400	SB104	SB108
		Left Hand	331602	341376						SM5403	SM5400	SB104	SB108

## ACURA SLX

1996-99	ALL				KG54304	KG54308	565022	565023					
---------	-----	--	--	--	---------	---------	--------	--------	--	--	--	--	--

## ACURA TL

2009-10	AWD FWD									SM5401	SM5058		
2007-10	ALL									SM5058		SB108	SB107
2007-08	Strut Mount Kit									SM5058			
2006	ALL		341330	341331						SM5058	SM5058	SB108	SB107
2004-05	ALL		341330	341331						SM5058	SM5058	SB108	SB108
1999-03	3.2L (Inc. Type S)		341257	341258			741049	741050		SM5058	SM5058	SB108	SB107
1996-98	3.2L Mount Plate w/ Insulator	Right Hand	341430	341436						SM5289	SM5059	SB108	SB107
		Left Hand	341431	341436						SM5289	SM5059 SM5515	SB108	SB107
1995-98	2.5L Mount Plate w/ Insulator (2.5L) Upper Spring Seat Insulator (2.5L)	Right Hand	341446	341424						SM5058	SM5059	SB108	SB107
		Left Hand	341447	341424						SM5058 SM5514 SM5486	SM5059 SM5515	SB108	SB107

## ACURA TSX





2009-10	TSX									SM5058	SM5058	SB108	SB108
2004-08	TSX		341330	341495						SM5058	SM5058	SB108	SB108

## ACURA Vigor

1992-94	ALL Mount Plate w/ Insulator Upper Spring Seat Insulator									SM5058 SM5514 SM5486	SM5059 SM5515	SB108	SB107
---------	--	--	--	--	--	--	--	--	--	----------------------------	------------------	-------	-------

Notes de bas de Page 320 - Guia de notas al calce del catalogo Pg. 321  
 Bold part numbers indicate the most comparable KYB product to the original design & performance.  
 (22) For vehicles with Electronic Susp., Leveling Control, and Air Suspensions refer to Appendix C.

# Applications For Pass. Cars, Light Trucks, SUV's, & Vans

VEHICLE MAKE, MODEL & YEAR		<b>GR-2</b> <i>Excel-G</i>		<b>Gas-a-Just</b>		<b>MonoMax</b> 56XXXX Series <b>AGX</b> 7XXXXX Series		STRUT & SHOCK MOUNTS		BOOT KITS	
MARQUE, MODELE ET ANNEE DU VEHICULE											
LA MARCA EL MODELO & AÑO											

## AMC Ambassador

1970-74	ALL	343156	343149	KG4505	KG5522						
1958-69	ALL (Exc. 1958 - 60 Air Susp.)		343149								

## AMC American

1967-68	ALL		343135	KG4503	KG5521						
1958-66	ALL		343135								

## AMC AMX

1978-80	ALL	343156	344052	KG4505							
1970-74	ALL	343156	343135	KG4505	KG5521						
1968-69	ALL		343135	KG4503	KG5521						

## AMC Classic

1961-66	ALL		343149								
---------	-----	--	--------	--	--	--	--	--	--	--	--

## AMC Concord

1978-83	ALL	343156	344052	KG4505							
---------	-----	--------	--------	--------	--	--	--	--	--	--	--

## AMC Eagle

1980-88	ALL	343156	343149	KG4505	KG5522						
---------	-----	--------	--------	--------	--------	--	--	--	--	--	--

## AMC Gremlin

1971-78	ALL	343156	344052	KG4505							
1970	ALL	343156	343130	KG4505	KG5507						

## AMC Hornet

1971-77	ALL	343156	344052	KG4505							
1970	ALL	343156	343130	KG4505	KG5507						

## AMC Javelin

1970-74	ALL	343156	343135	KG4505	KG5521						
1968-69	ALL		343135	KG4503	KG5521						

## AMC Marlin

1965-67	ALL		343149								
---------	-----	--	--------	--	--	--	--	--	--	--	--

## AMC Matador

1971-78	ALL	343156	343149	KG4505	KG5522						
---------	-----	--------	--------	--------	--------	--	--	--	--	--	--

## AMC Rambler





1969	ALL		343135	KG4503	KG5521						
------	-----	--	--------	--------	--------	--	--	--	--	--	--

## AMC Rebel

1970	ALL	343156	343149	KG4505	KG5522						
1966-69	ALL		343149								

Notes de bas de Page 320 - Guia de notas al calce del catalogo Pg. 321  
 Bold part numbers indicate the most comparable KYB product to the original design & performance.  
 (22) For vehicles with Electronic Susp., Leveling Control, and Air Suspensions refer to Appendix C.

# Applications For Pass. Cars, Light Trucks, SUV's, & Vans

VEHICLE MAKE, MODEL & YEAR		<b>GR-2</b> <i>Excel-G</i>		<b>Gas-a-Just</b>		<b>MonoMax</b> 56XXXX Series <b>AGX</b> 7XXXX Series		STRUT & SHOCK MOUNTS		BOOT KITS	
MARQUE, MODELE ET ANNEE DU VEHICULE											
LA MARCA EL MODELO & AÑO											

## AMC Spirit

1979-83	ALL	343156	344052	KG4505							
---------	-----	--------	--------	--------	--	--	--	--	--	--	--

## ASUNA Sedan SE/GT (Canadian Vehicle)

1992-94	ALL	365025		KG4543				SM5378	SM5010	SB101	SB105
---------	-----	--------	--	--------	--	--	--	--------	--------	-------	-------

## ASUNA Sunfire (Canadian Vehicle)

1993-94	ALL (Exc. Lotus Susp.)	Right Hand	234041	232033				SM5081	SM5105	SB102	SB105
		Left Hand	234042	232034				SM5081	SM5105	SB102	SB105
	ALL w/ Lotus Susp.	Right Hand	234041	332076				SM5081	SM5105	SB102	SB105
		Left Hand	234042	332077				SM5081	SM5105	SB102	SB105

## ASUNA Sunrunner (Canadian Vehicle)

1996-98	ALL w/ 4 Wheel ABS		343247		KG4745A			SM5082			
1993-98	ALL (Exc. ABS)	Right Hand	235035	343247		KG4745A		SM5082			
		Left Hand	235036	343247		KG4745A		SM5082			

## AUDI 80/90 Series

1994-95	Cabriolet	365008						SM5034		SB102	
9/91-95	ALL (Exc. Quattro) Quattro (Exc. 20V)	365008	341130					SM5034		SB102	
		365008						SM5034		SB121	
1988-8/91	ALL (Exc. Quattro) Quattro (Exc. 20V)	365008			KG9006 <sup>2</sup>			SM5034		SB121	SB105
		365008	366006					SM5034		SB121	SB105

## AUDI 100 Series

1991-94	Strut Mount Bearing							SM5134			
12/90-95	ALL (Exc. Quattro, S4 & Sport Susp.)	366002	341133					SM5183	SM5120	SB105	SB105
12/90-94	Quattro (Exc. Sport Susp.)	366002	341205					SM5183	SM5120	SB120	SB105
1988-11/90	ALL (Exc. Quattro) Quattro	366002	341016					SM5249		SB104	SB105
		366002						SM5249		SB101	SB105
1988-90	Strut Mount Bearing							SM5071			

## AUDI 200 Series

1988-91	ALL (Exc. Quattro)	366002	341016					SM5052	SM5120	SB104	
	Quattro	366002						SM5052	SM5120	SB101	
	Strut Mount Bearing							SM5071			

## AUDI 4000 Series

1984-87	Quattro	365008	366006					SM5034		SB121	SB105
1980-87	ALL (Exc. Quattro)	365008			KG9006 <sup>2</sup>			SM5034		SB121	

## AUDI 5000 Series

1986-88	Quattro	366002						SM5052		SB104	
1984-88	ALL (Exc. Quattro)	366002	341016					SM5052		SB104	
1980-88	Strut Mount Bearing							SM5071			
1980-83	ALL	366002	343013		KG5549			SM5052		SB104	
1979-88	Strut Mounting Kit							SM5249			
1977-79	ALL	366002	343013		KG5549					SB103	

<sup>2</sup> The KYB replacement unit comes with a new dustcover/ bumper assembly.

Notes de bas de Page 320 - Guia de notas al calce del catalogo Pg. 321  
 Bold part numbers indicate the most comparable KYB product to the original design & performance.  
 (22) For vehicles with Electronic Susp., Leveling Control, and Air Suspensions refer to Appendix C.

# Applications For Pass. Cars, Light Trucks, SUV's, & Vans

VEHICLE MAKE, MODEL & YEAR									
MARQUE, MODELE ET	<b>GR-2</b> <i>Excel-G</i>	<b>Gas-a-Just</b>	<b>MonoMax</b> 56XXXX Series <b>AGX</b> 7XXXX Series	STRUT & SHOCK		MOUNTS		BOOT KITS	
ANNEE DU VEHICULE									
LA MARCA EL MODELO & AÑO									

## AUDI A3

2006-09	ALL							SM5567		SB101	SB125
---------	-----	--	--	--	--	--	--	--------	--	-------	-------

## AUDI A4

2009-10	Sedan & Wagon w/ Sport Susp.									SB122	
2008-09	Cabriolet							SM5446	SM5237	SB122	SB115
2007	Cabriolet	341676 <sup>70</sup>	343602 <sup>70</sup>					SM5446	SM5237	SB122	SB115
11/04-08	Avant Wagon	341299	344807								
	Avant Wagon w/ Sport Susp.	341299	344808								
	Sedan	341299	344807								
	Sedan w/ Sport Susp. - From 11/04	341299	344808								
2003-06	Cabriolet	341299	341814					SM5446	SM5237	SB122	SB114
2002-06	Shock Mount (Incl. Cabriolet)							SM5446			
2002-04	ALL w/ Sport Susp.										SB114
	ALL w/o Sport Susp.										SB124
10/01-11/04	Avant Wagon (Inc. Quattro)	341299	341814							SB122	
2001-02	Cabriolet	341676 <sup>70</sup>	343602 <sup>70</sup>								
11/00-11/04	Sedan (Inc. Quattro)	341299	341814							SB122	
2/99-9/01	Avant Wagon w/o Sport Susp. (Exc. Quattro)	341842	343302					SM5236	SM5377	SB122	SB114
	Quattro Avant w/o Sport Susp.	341842	341909								
	Avant Wagon w/ Sport Susp. (Exc. Quattro)		343302					SM5236	SM5377	SB122	SB114
	Quattro Avant w/ Sport Susp.		341909								
2/99-11/00	Quattro Sedan w/o Sport Susp.	341842	341909					SM5236	SM5377	SB122	SB114
	Sedan w/o Sport Susp. (Exc. Quattro)	341842	343302								
	Quattro Sedan w/ Sport Susp.		341909								
	Sedan w/ Sport Susp. (Exc. Quattro)		343302					SM5236	SM5377	SB122	SB114
1998-99	Avant Wagon w/o Sport Susp. (Exc. Quattro)	341842	343271					SM5236	SM5377	SB122	SB114
	Quattro Avant Wagon	341842	341909					SM5236		SB122	
	Avant Wagon w/ Sport Susp. (Exc. Quattro)		343271					SM5236	SM5377	SB122	SB114
1996-01	Spring Seat w/ Insulator							SM5545			
1995-1/99	Quattro Sedan	341842	341909					SM5236		SB122	
	Sedan w/o Sport Susp. (Exc. Quattro)	341842	343271					SM5236	SM5377	SB122	SB114
	Sedan w/ Sport Susp. (Exc. Quattro)		343271					SM5236	SM5377	SB122	SB114

## AUDI A6

2009-10	ALL (Exc. Air Susp.) ALL		344806 <sup>68</sup>					SM5446		SB122	SB115
2005-10	ALL								SM5237		SB115
2005-08	ALL (Exc. Air Susp.)	341823 <sup>68</sup>	344806 <sup>68</sup>					SM5446		SB122	
1999-04	Quattro From Vin 4B-W-100001	341273	341677 <sup>70</sup>					SM5236	SM5237	SB122	
1998-04	ALL (Exc. Quattro)	341273	343281					SM5236	SM5237	SB122	
	Spring Seat w/ Insulator							SM5545			
1998	Quattro	341207						SM5236	SM5237	SB122	
1995-97	ALL (Exc. Quattro)	366002	341133					SM5183	SM5237	SB120	
	Quattro	366002	341205					SM5183	SM5237	SB120	
	Strut Mount Bearing							SM5134			

<sup>68</sup> New Part Number; Available 3rd Quarter 2011

<sup>70</sup> New Part Number; Available 2nd Quarter 2011

Notes de bas de Page 320 - Guia de notas al calce del catalogo Pg. 321

Bold part numbers indicate the most comparable KYB product to the original design & performance.

(22) For vehicles with Electronic Susp., Leveling Control, and Air Suspensions refer to Appendix C.

# Applications For Pass. Cars, Light Trucks, SUV's, & Vans

VEHICLE MAKE, MODEL & YEAR		<b>GR-2</b>		<b>Gas-a-Just</b>		<b>MonoMax</b> 56XXXX Series		STRUT & SHOCK		BOOT KITS	
MARQUE, MODELE ET		<b>Excel-G</b>				<b>AGX</b> 7XXXXX Series		MOUNTS			
ANNEE DU VEHICULE											
LA MARCA EL MODELO & AÑO											

## AUDI A8

1997-03	ALL							SM5236		SB122	
---------	-----	--	--	--	--	--	--	--------	--	-------	--

## AUDI Allroad Quattro

2001-05	ALL							SM5236			
---------	-----	--	--	--	--	--	--	--------	--	--	--

## AUDI Coupe

1981-87	ALL	365008			KG9006 <sup>2</sup>			SM5034		SB121	
---------	-----	--------	--	--	---------------------	--	--	--------	--	-------	--

## AUDI Fox

1973-79	Sedan Station Wagon	364001 364001			KG5532			SM5011 SM5011		SB103 SB103	
---------	------------------------	------------------	--	--	--------	--	--	------------------	--	----------------	--

## AUDI Q7

2007-09	ALL w/ Air Susp. ALL w/o Air Susp.									SB104 SB101	
---------	---------------------------------------	--	--	--	--	--	--	--	--	----------------	--

## AUDI RS4

2007-08	ALL							SM5446	SM5237	SB122	SB124
---------	-----	--	--	--	--	--	--	--------	--------	-------	-------

## AUDI S4

2009-10	Sedan & Wagon w/ Sport Susp.									SB122	
2009	Convertible							SM5446	SM5237	SB122	SB115
2007-08	ALL										SB115
2004-08	ALL							SM5446	SM5237	SB122	
2000-02	ALL Spring Seat w/ Insulator							SM5236 SM5545		SB122	
1992-95	ALL							SM5249		SB105	

## AUDI S6, S8

2009-10	S6 (Exc. Air Susp.)							SM5446	SM5237	SB122	SB115
2007-08	S6 (Exc. Air Susp.)		344806 <sup>68</sup>					SM5446	SM5237	SB122	SB115
2002-03	S6 (Exc. Air Susp.) S6 Upper Spring Seat w/ Insulator	341273						SM5236 SM5545		SB122	
2001-03	S8							SM5236		SB122	
1995-97	S6							SM5183		SB105	

## AUDI TT (Exc. Quattro)

2008-09	ALL							SM5567		SB101	SB124
2000-06	ALL w/ 18" Wheels w/o 18" Wheels	334676	343452				743029	SM5181	SM5182	SB123 SB103	SB125











## AUDI TT (Quattro)

2009	ALL w/ 2.0L Engine							SM5567			
2008-09	Strut / Shock Boot									SB101	SB124
2000-06	ALL w/ 18" Wheels w/o 18" Wheels	334676	343453					SM5181		SB123 SB103	

<sup>2</sup> The KYB replacement unit comes with a new dustcover/ bumper assembly.

<sup>68</sup> New Part Number; Available 3rd Quarter 2011

# Applications For Pass. Cars, Light Trucks, SUV's, & Vans

VEHICLE MAKE, MODEL & YEAR	<b>GR-2</b>	<b>Gas-a-Just</b>	<b>MonoMax</b> 56XXXX Series	STRUT & SHOCK	
MARQUE, MODELE ET	<b>Excel-G</b>		<b>AGX</b> 7XXXXX Series	MOUNTS	BOOT KITS
ANNEE DU VEHICULE	 	 	 	 	 
LA MARCA EL MODELO & AÑO					

## AUDI V8

1992-94	ALL	366002						SM5052		SB105	
1990-91	Strut Mounting Kit							SM5249			

## AVANTI II

1989-91	ALL	343127	343130	KG4513	KG5507						
1986-88	ALL	343127	343157	KG4513	KG5548						
1965-85	ALL	343127		KG4550							

## BERTONE X-1/9

1983-86	ALL	233003	233004								
---------	-----	--------	--------	--	--	--	--	--	--	--	--

## BMW 128I

2008-10	Strut Mount							SM5260			
---------	-------------	--	--	--	--	--	--	--------	--	--	--

## BMW 135I

2008-10	Strut Mount							SM5260			
---------	-------------	--	--	--	--	--	--	--------	--	--	--

## BMW 1600/2, 2002, 2002Ti, 2002Tii

1966-76	ALL (E10)	363013			KG5540			SM5080			
---------	-----------	--------	--	--	--------	--	--	--------	--	--	--

## BMW 2500,2800, 3.0S Sedan, 3.0 Bavaria

1969-76	ALL (E3)	365002			KG9303						SB107
---------	----------	--------	--	--	--------	--	--	--	--	--	-------

## BMW 2800 CS, 3.0 CS Coupe

1969-76	ALL (E3)	365002									
---------	----------	--------	--	--	--	--	--	--	--	--	--

## BMW 318 Series (Exc. M-Technik Susp.)

1995-99	318Ti (E36) (Exc. Sport Susp.)	Right Hand	333909 <sup>27</sup>					SM5255	SM5013	SB101	SB107
		Left Hand	333910 <sup>28</sup>					SM5255	SM5013	SB101	SB107
1994-97	318i (E36) Convertible (Exc. Sport Susp.)	Right Hand	334901	343352		553239 <sup>68</sup>		SM5255	SM5013	SB112	SB107
		Left Hand	334902	343352		553239 <sup>68</sup>		SM5255	SM5013	SB112	SB107
6/92-3/98	318i (E36) Convertible w/ Sport Susp.	Right Hand	333909 <sup>27</sup>	343352		553239 <sup>68</sup>		SM5255	SM5013	SB112	SB107
		Left Hand	333910 <sup>28</sup>	343352		553239 <sup>68</sup>		SM5255	SM5013	SB112	SB107
1986-3/92	318i (E30) Convertible		364021 <sup>1</sup>			KG4539		SM5053	SM5013	SB105	
		318is (E30)	364021 <sup>1</sup>			KG4539		SM5053	SM5013	SB105	
1983-85	318i (E30) (Exc. Sport Susp.) (45mm Housing)		363044			KG4539		SM5053	SM5013	SB105	
		318is (E30) (51mm Housing)	364021			KG4539		SM5053	SM5013	SB105	

## BMW 320 Series (Exc. M-Technik Susp.)

1993-1/95	320i (E36)	Right Hand	334901			KG9136		SM5255	SM5013		
		Left Hand	334902			KG9136		SM5255	SM5013		
1977-83	320i (E21)	363016				KG9004 <sup>2</sup>		SM5080		SB112	SB113

## BMW 323 Series (Exc. M-Technik Susp.)

2000	323Ci (E46) (Exc. Sport Susp.)	Right Hand	334945	343352		553239 <sup>68</sup>		SM5260	SM5257	SB112	SB107	
		Left Hand	334946	343352		553239 <sup>68</sup>		SM5260	SM5257	SB112	SB107	
	323Ci (E46) w/ Sport Susp.	Right Hand	334614	343352			553239 <sup>68</sup>		SM5260	SM5257	SB112	SB107
		Left Hand	334615	343352			553239 <sup>68</sup>		SM5260	SM5257	SB112	SB107

<sup>1</sup> The original High Pressure Gas Strut Cartridge can be replaced by [364021] with Boot Kit # [SB101]

<sup>2</sup> The KYB replacement unit comes with a new dustcover/ bumper assembly.

<sup>27</sup> When [333909] stock is depleted, use [333919]

<sup>28</sup> When [333910] stock is depleted, use [333920]

<sup>68</sup> New Part Number; Available 3rd Quarter 2011

# Applications For Pass. Cars, Light Trucks, SUV's, & Vans

VEHICLE MAKE, MODEL & YEAR	<b>GR-2</b>		<b>Gas-a-Just</b>		<b>MonoMax</b> 56XXXX Series		STRUT & SHOCK		BOOT KITS	
MARQUE, MODELE ET	<b>Excel-G</b>				<b>AGX</b>		MOUNTS			
ANNEE DU VEHICULE					7XXXXX Series					
LA MARCA EL MODELO & AÑO										

## BMW 323 Series (Exc. M-Technik Susp.) (continued)

1999-00	323i (E46) w/ Sport Susp.	Right Hand	334614	343352		553239 <sup>68</sup>			SM5260	SM5257	SB112	SB107
		Left Hand	334615	343352		553239 <sup>68</sup>			SM5260	SM5257	SB112	SB107
	323i (E46) w/ Standard Susp.	Right Hand	334945	343352		553239 <sup>68</sup>			SM5260	SM5257	SB112	SB107
		Left Hand	334946	343352		553239 <sup>68</sup>			SM5260	SM5257	SB112	SB107
1998-99	323iC (E36) Convertible (Exc. Sport Susp.)	Right Hand	334901	343352		553239 <sup>68</sup>			SM5255		SB112	SB107
		Left Hand	334902	343352		553239 <sup>68</sup>			SM5255		SB112	SB107
	323is (E36) (Exc. Sport Susp.)	Right Hand	333919	343352		553239 <sup>68</sup>			SM5255		SB112	SB107
		Left Hand	333920	343352		553239 <sup>68</sup>			SM5255		SB112	SB107
		Left Hand										
		Left Hand										

## BMW 325 (Exc. M-Technik Susp.)

9/87-88	ALL (E30) w/ High Pressure Strut		364021 <sup>1</sup>			KG4539			SM5053	SM5013		
	NOTE: High Pressure Strut has 1 1/2" piston rod											
	ALL (E30) (Exc. High Pressure Strut)		364021			KG4539			SM5053	SM5013	SB105	
1984-8/87	ALL (E30)		364021			KG4539			SM5053	SM5013	SB105	

## BMW 325Ci (Exc. M-Technik Susp.)

2001-06	Convertible (E46) (Exc. Sport Susp.)	Right Hand	334945	343352					SM5260	SM5257	SB112	SB107
		Left Hand	334946	343352					SM5260	SM5257	SB112	SB107
	Convertible (E46) w/ Sport Susp.	Right Hand	334614	343352					SM5260	SM5257	SB112	SB107
		Left Hand	334615	343352					SM5260	SM5257	SB112	SB107
	Coupe (E46) (Exc. Sport Susp.)	Right Hand	334945	343352		553239 <sup>68</sup>			SM5260	SM5257	SB112	SB107
		Left Hand	334946	343352		553239 <sup>68</sup>			SM5260	SM5257	SB112	SB107
	Coupe (E46) w/ Sport Susp.	Right Hand	334614	343352		553239 <sup>68</sup>			SM5260	SM5257	SB101	SB107
		Left Hand	334615	343352		553239 <sup>68</sup>			SM5260	SM5257	SB101	SB107

## BMW 325e (Exc. M-Technik Susp.)

9/87-88	ALL (E30) w/ High Pressure Strut		364021 <sup>1</sup>			KG4539			SM5053	SM5013		
	NOTE: High Pressure Strut has 1 1/2" piston rod											
	ALL (E30) (Exc. High Pressure Strut)		364021			KG4539			SM5053	SM5013	SB105	
1984-8/87	ALL (E30)		364021			KG4539			SM5053	SM5013	SB105	

## BMW 325i (Exc. M-Technik Susp.)

2006	ALL	Right Hand	334627	349041					SM5260			
		Left Hand	334628	349041					SM5260			
2001-05	ALL (E46) (Exc. Sport Susp.)	Right Hand	334945	343352		553239 <sup>68</sup>			SM5260	SM5257	SB112	SB107
		Left Hand	334946	343352		553239 <sup>68</sup>			SM5260	SM5257	SB112	SB107
	ALL (E46) w/ Sport Susp.	Right Hand	334614	343352		553239 <sup>68</sup>			SM5260	SM5257	SB112	SB107
		Left Hand	334615	343352		553239 <sup>68</sup>			SM5260	SM5257	SB112	SB107
2/95-96	ALL (E36) (Exc. Sport Susp.)	Right Hand	333919	343255		KG9136			SM5255	SM5013	SB112	SB107
		Left Hand	333920	343255		KG9136			SM5255	SM5013	SB112	SB107
6/92-1/95	ALL (E36) (Exc. Sport Susp.)	Right Hand	334901	343255		KG9136						
		Left Hand	334902	343255		KG9136						
	ALL (E36) (w/ Sport Susp.)	Right Hand	334937									
		Left Hand	334938									
1988-91	ALL (E30)		364021 <sup>1</sup>			KG4539			SM5053	SM5013	SB105	

<sup>1</sup> The original High Pressure Gas Strut Cartridge can be replaced by [364021] with Boot Kit # [SB101]

<sup>68</sup> New Part Number; Available 3rd Quarter 2011





Notes de bas de Page 320 - Guia de notas al calce del catalogo Pg. 321

Bold part numbers indicate the most comparable KYB product to the original design & performance.

(22) For vehicles with Electronic Susp., Leveling Control, and Air Suspensions refer to Appendix C.



# Applications For Pass. Cars, Light Trucks, SUV's, & Vans

VEHICLE MAKE, MODEL & YEAR		<b>GR-2</b>		<b>Gas-a-Just</b>		<b>MonoMax</b> 56XXXX Series		STRUT & SHOCK			
MARQUE, MODELE ET		<b>Excel-G</b>				<b>AGX</b> 7XXXXX Series		MOUNTS		BOOT KITS	
ANNEE DU VEHICULE											
LA MARCA EL MODELO & AÑO											
											

## BMW 325ic (Exc. M-Technik Susp.)

1994-95	ALL (E36) (Exc. Sport Susp.)	Right Hand	334901	343255		KG9136			SM5255	SM5013	SB112	SB107
		Left Hand	334902	343255		KG9136			SM5255	SM5013	SB112	SB107
	ALL (E36) (w/ Sport Susp.)	Right Hand	334937						SM5255	SM5013	SB112	SB107
		Left Hand	334938						SM5255	SM5013	SB112	SB107

## BMW 325is (Exc. M-Technik Susp.)

2/95-96	ALL (E36) (Exc. Sport Susp.)	Right Hand	333919	343255		KG9136			SM5255	SM5013	SB112	SB107
		Left Hand	333920	343255		KG9136			SM5255	SM5013	SB112	SB107
6/92-1/95	ALL (E36) (Exc. Sport Susp.)	Right Hand	334901	343255		KG9136				SM5013		
		Left Hand	334902	343255		KG9136				SM5013		
	ALL (E36) (w/ Sport Susp.)	Right Hand	334937									
		Left Hand	334938									
1988-91	ALL (E30)		364021 <sup>1</sup>			KG4539			SM5053	SM5013	SB105	

## BMW 325iT (Exc. M-Technik Susp.)

2001-05	ALL (E46) w/ Sport Susp.	Right Hand	334614	343352					SM5260	SM5257	SB112	SB107
		Left Hand	334615	343352					SM5260	SM5257	SB112	SB107
2001-04	ALL (E46) (Exc. Sport Susp.)	Right Hand	334945	343352					SM5260	SM5257	SB112	SB107
		Left Hand	334946	343352					SM5260	SM5257	SB112	SB107

## BMW 325iX (Exc. M-Technik Susp.)

1988-91	ALL (E30)					KG4539				SM5013		
---------	-----------	--	--	--	--	--------	--	--	--	--------	--	--

## BMW 325xi

2001-05	ALL			343352		553239 <sup>68</sup>			SM5260	SM5257	SB110	SB107
---------	-----	--	--	--------	--	----------------------	--	--	--------	--------	-------	-------

## BMW 328Ci

2000	Coupe (E46) (Exc. Sport Susp.)	Right Hand	334945	343352		553239 <sup>68</sup>			SM5260	SM5257	SB112	SB107
		Left Hand	334946	343352		553239 <sup>68</sup>			SM5260	SM5257	SB112	SB107
	Coupe (E46) w/ Sport Susp.	Right Hand	334614	343352		553239 <sup>68</sup>			SM5260	SM5257	SB112	SB107
		Left Hand	334615	343352		553239 <sup>68</sup>			SM5260	SM5257	SB112	SB107

## BMW 328i (Exc. M-Technik Susp.)

2007-10	Sedan, Coupe & Convertible	Right Hand	334627	349041					SM5260			
		Left Hand	334628	349041					SM5260			
1999-00	ALL (E46) (Exc. Sport Susp.)	Right Hand	334945	343352		553239 <sup>68</sup>			SM5260	SM5257	SB112	SB107
		Left Hand	334946	343352		553239 <sup>68</sup>			SM5260	SM5257	SB112	SB107
	ALL (E46) w/ Sport Susp.	Right Hand	334614	343352		553239 <sup>68</sup>			SM5260	SM5257	SB112	SB107
		Left Hand	334615	343352		553239 <sup>68</sup>			SM5260	SM5257	SB112	SB107
1996-99	ALL (E36) (w/ Sport Susp.)	Right Hand	334937						SM5255	SM5013	SB112	SB107
		Left Hand	334938						SM5255	SM5013	SB112	SB107
	Convertible (E36) (Exc. Sport Susp.)	Right Hand	333919	343352		553239 <sup>68</sup>			SM5255	SM5013	SB112	SB107
		Left Hand	333920	343352		553239 <sup>68</sup>			SM5255	SM5013	SB112	SB107
	Sedan (E36) (Exc. Sport Susp.)	Right Hand	333919	343352		553239 <sup>68</sup>			SM5255	SM5013	SB112	SB107
		Left Hand	333920	343352		553239 <sup>68</sup>			SM5255	SM5013	SB112	SB107

## BMW 328is

1996-99	ALL (E36) (Exc. Sport Susp.)	Right Hand	333919	343352		553239 <sup>68</sup>			SM5255	SM5013	SB112	SB107
		Left Hand	333920	343352		553239 <sup>68</sup>			SM5255	SM5013	SB112	SB107
	ALL (E36) (w/ Sport Susp.)	Right Hand	334937						SM5255	SM5013	SB112	SB107
		Left Hand	334938						SM5255	SM5013	SB112	SB107

<sup>1</sup> The original High Pressure Gas Strut Cartridge can be replaced by [364021] with Boot Kit # [SB101]

<sup>68</sup> New Part Number; Available 3rd Quarter 2011

# Applications For Pass. Cars, Light Trucks, SUV's, & Vans

VEHICLE MAKE, MODEL & YEAR	<b>GR-2</b>		<b>Gas-a-Just</b>		<b>MonoMax</b> 56XXXX Series		STRUT & SHOCK		BOOT KITS	
MARQUE, MODELE ET	<b>Excel-G</b>				<b>AGX</b>		MOUNTS			
ANNEE DU VEHICULE					7XXXXX Series					
LA MARCA EL MODELO & AÑO										

## BMW 330Ci, i Series

2006	ALL (E90)	Right Hand	334627	349041				SM5260			
		Left Hand	334628	349041				SM5260			
	Coupe & Convertible (E46) w/ Standard Susp.	Right Hand	334945	343352		553239 <sup>68</sup>		SM5260	SM5257	SB112	SB107
		Left Hand	334946	343352		553239 <sup>68</sup>		SM5260	SM5257	SB112	SB107
2001-06	Convertible (E46) w/ Sport Susp.	Right Hand	334614	343352		553239 <sup>68</sup>		SM5260	SM5257	SB101	SB107
		Left Hand	334615	343352		553239 <sup>68</sup>		SM5260	SM5257	SB101	SB107
2001-05	ALL (E46) (Exc. Sport Susp.)	Right Hand	334945	343352		553239 <sup>68</sup>		SM5260	SM5257	SB112	SB107
		Left Hand	334946	343352		553239 <sup>68</sup>		SM5260	SM5257	SB112	SB107
2001 - 9/01	Coupe (E46) w/ Performance Susp.	Right Hand	334614								
		Right Hand	334614								
2001	Sedan (E46) w/ Sport Susp.	Right Hand	334614	343352		553239 <sup>68</sup>		SM5260	SM5257	SB101	SB107
		Left Hand	334615	343352		553239 <sup>68</sup>		SM5260	SM5257	SB101	SB107

## BMW 330xi

2001-05	ALL							SM5260	SM5257	SB110	SB107
---------	-----	--	--	--	--	--	--	--------	--------	-------	-------

## BMW 335d

2009-10	Strut Mount							SM5260			
---------	-------------	--	--	--	--	--	--	--------	--	--	--

## BMW 335i

2007-10	ALL	Right Hand	334627	349041				SM5260			
		Left Hand	334628	349041				SM5260			

## BMW 524 Series (Exc. M-Technik Susp.)

1985-2/88	524td					KG9307		SM5053		SB105	SB107
-----------	-------	--	--	--	--	--------	--	--------	--	-------	-------

## BMW 525 Series (Exc. M-Technik Susp. & Electronic Susp.)

2004-07	ALL							SM5260			
2001-9/03	525i Sedan (E39)	Right Hand	334674 <sup>70</sup>	341678 <sup>70</sup>				SM5260	SM5251	SB110	SB107
		Left Hand	334675 <sup>70</sup>	341678 <sup>70</sup>				SM5260	SM5251	SB110	SB107
	525iT Wagon (E39)	Right Hand	334674 <sup>70</sup>			552600 <sup>70</sup>		SM5260	SM5251	SB112	SB107
		Left Hand	334675 <sup>70</sup>			552600 <sup>70</sup>		SM5260	SM5251	SB112	SB107
10/92-1995	525i (E34) Sedan		365083	341081				SM5053	SM5256	SB112	SB107
1992-95	525iT Wagon (E34) (Exc. Adj. Susp.)		366007	341081				SM5053	SM5256	SB112	SB107
7/90-9/92	525i (E34) (Exc. Self-Leveling & M-Tronic)		366007	341081					SM5251	SB105	SB107
1990 - 6/90	525i (E34)		366005	341081					SM5251	SB105	SB107
1/88-89	525i (E34)		366005	341081					SM5251	SB105	

## BMW 528 Series (Exc. Electronic Susp.)



2008-10	Strut Mount							SM5260			
1997-00	528i (E39) w/ EDC Susp.							SM5261		SB110	SB107
9/95-00	528i Sedan (E39) (Exc. EDC Susp.)	Right Hand	334674 <sup>70</sup>	341840 <sup>63</sup>				SM5260	SM5251	SB112	SB107
		Left Hand	334675 <sup>70</sup>	341840 <sup>63</sup>				SM5260	SM5251	SB112	SB107
	528iT Wagon (E39)	Right Hand	334674 <sup>70</sup>			552600 <sup>70</sup>		SM5260	SM5251	SB112	SB108
		Left Hand	334675 <sup>70</sup>			552600 <sup>70</sup>		SM5260	SM5251	SB112	SB108
1982-88	528e (E28) (Exc. Bilstein Equipped)		365043			KG9307		SM5053		SB105	SB107
1979-81	528i (E12)		365002			KG9303				SB105	SB107

<sup>68</sup> New Part Number; Available 3rd Quarter 2011

<sup>70</sup> New Part Number; Available 2nd Quarter 2011

<sup>63</sup> Replaces [341913], when stock is depleted

# Applications For Pass. Cars, Light Trucks, SUV's, & Vans

VEHICLE MAKE, MODEL & YEAR		<b>GR-2</b>		<b>Gas-a-Just</b>		<b>MonoMax</b> 56XXXX Series		STRUT & SHOCK			
MARQUE, MODELE ET		<b>Excel-G</b>				<b>AGX</b> 7XXXX Series		MOUNTS		BOOT KITS	
ANNEE DU VEHICULE											
LA MARCA EL MODELO & AÑO											

## BMW 530 Series (Exc. M-Technik Susp. & Electronic Susp.)

2004-07	Strut Mount							SM5260			
2001-9/03	530i Sedan (E39) To 9/03	Right Hand	334674 <sup>70</sup>	341678 <sup>70</sup>				SM5260	SM5251		SB107
		Left Hand	334675 <sup>70</sup>	341678 <sup>70</sup>				SM5260	SM5251		SB107
2001-03	ALL w/ Sport Suspension										SB110
	ALL w/o Sport Suspension										SB112
1994-95	530i (E34) Sedan (Exc. Self Leveling & M-Tronic)		366007	341081					SM5256		SB105
	530iT (E34) Wagon		366007						SM5256		SB112
1975-78	530i (E12)		365002		KG9302					SB105	SB107

## BMW 530xi

2006-07	Strut Mount							SM5260			
---------	-------------	--	--	--	--	--	--	--------	--	--	--

## BMW 533 Series

1983-84	533i (E28)		365043		KG9307			SM5053		SB105	SB107
---------	------------	--	--------	--	--------	--	--	--------	--	-------	-------

## BMW 535 Series (Exc. M-Technik Susp.)

2008-10	Strut Mount							SM5260			
7/90-9/92	535i (E34) (Exc. Self Leveling & M-Tronic)		366007	341081					SM5256	SB112	SB107
1/88-6/90	535i (E34)		366005	341081						SB105	
1985-12/87	535i, 535is (E28) (Exc. M5)		365043		KG9307			SM5053		SB105	SB107

## BMW 540 Series (Exc. Electronic Susp.)

2000-10/03	540iT (E39) Wagon		Right Hand	335600 <sup>70</sup>		552600 <sup>70</sup>		SM5261			SB108
	w/ Sport Susp.		Left Hand	335601 <sup>70</sup>		552600 <sup>70</sup>		SM5261			SB108
1997-03	540i (E39) Sedan		Right Hand	335600 <sup>70</sup>	341678 <sup>70</sup>			SM5261	SM5251		SB107
	ALL w/ Sport Suspension		Left Hand	335601 <sup>70</sup>	341678 <sup>70</sup>			SM5261	SM5251		SB107
	ALL w/o Sport Suspension									SB110	
	ALL w/o Sport Suspension									SB112	
1994-95	540i (E34) (Exc. Self-leveling & M-Tronic)		366007						SM5256	SB105	SB107

## BMW 545i

2004-05	ALL							SM5260			
---------	-----	--	--	--	--	--	--	--------	--	--	--

## BMW 550i

2006-10	Strut Mount							SM5260			
---------	-------------	--	--	--	--	--	--	--------	--	--	--

## BMW 630 Series

1979-82	630CSI (E24)		365024		KG9303					SB105	SB107
1976-78	630CSI (E24)		365002		KG9303					SB105	SB107











## BMW 633 Series

1979-82	633CSI (E24)		365024		KG9303					SB105	SB107
1976-78	633CSI (E24)		365002		KG9303					SB105	SB107

<sup>70</sup> New Part Number, Available 2nd Quarter 2011

Notes de bas de Page 320 - Guia de notas al calce del catalogo Pg. 321  
 Bold part numbers indicate the most comparable KYB product to the original design & performance.  
 (22) For vehicles with Electronic Susp., Leveling Control, and Air Suspensions refer to Appendix C.

# Applications For Pass. Cars, Light Trucks, SUV's, & Vans

VEHICLE MAKE, MODEL & YEAR	<b>GR-2</b>	<b>Gas-a-Just</b>	<b>MonoMax</b> 56XXXX Series	STRUT & SHOCK	
MARQUE, MODELE ET	<b>Excel-G</b>		<b>AGX</b> 7XXXXX Series	MOUNTS	BOOT KITS
ANNEE DU VEHICULE	 	 	 	 	 
LA MARCA EL MODELO & AÑO					

## BMW 635 Series

1990	635CSI (E24) (Exc. Bilstein Equipped)	365043		KG9307					SB105	SB107
1985-89	635CSI (E24) (Exc. Bilstein Equipped)	365043		KG9307			SM5053		SB105	SB107

## BMW 645CI

2004-05	ALL						SM5260			
---------	-----	--	--	--	--	--	--------	--	--	--

## BMW 650i

2006-09	ALL						SM5260			
---------	-----	--	--	--	--	--	--------	--	--	--

## BMW 733i

1982-84	733i (E23) (Exc. Self Leveling)	365024	341043						SB105	SB107
1978-81	733i (E23)	365024		KG9308					SB105	SB107

## BMW 735 Series (Exc. M-Technik Susp.)

8/90-92	735i, 735iL (E32) (Exc. Self Leveling & M-Tronic)	366007	341129					SM5121	SB105	SB107
3/88-7/90	735i, 735iL (E32) (Exc. Self Leveling & M-Tronic)	366005	341129					SM5121	SB105	SB107
9/86-2/88	735i, 735iL (E32) (Exc. Self Leveling & M-Tronic)	365082	341129					SM5121	SB105	SB107
9/84-8/86	735i (E23) (Exc. Self Leveling)	365024	341043						SB105	SB107

## BMW 740 Series (Exc. M-Technik Susp.)

1995-01	740i & 740iL (E38) (Exc. Level Control & EDC Susp.) Right Hand Left Hand	335906	341211					SM5252	SM5250	SB112	SB107
		335907	341211					SM5252	SM5250	SB112	SB107
1993-94	740i (E32) (Exc. Self Leveling & M-Tronic) 740iL (E32) (Exc. Self Leveling & M-Tronic)	366007	341129					SM5121		SB105	SB107
		366005						SM5121		SB105	

## BMW 745 Series

2002-05	745 (E65 / E66) w/ EDC									SB112	
---------	------------------------	--	--	--	--	--	--	--	--	-------	--

## BMW 750 Series (Exc. M-Technik Susp.)

2006-08	750 (E65 / E66) w/ EDC									SB112	
1994-01	750iL (E38) w/o Level control & EDC Susp. Right Hand Left Hand	335906						SM5252			SB107
		335907						SM5252			SB107
7/90-94	750i, 750iL (E32) (Exc. Self Leveling & M-Tronic)	366005								SB105	
1988-6/90	750i, 750iL (E32) (Exc. Self Leveling & M-Tronic)	366005								SB105	

## BMW 760 Series









2003-08	760 (E65 / E66) w/ EDC									SB112	
---------	------------------------	--	--	--	--	--	--	--	--	-------	--

## BMW 840CI

1994-97	Strut / Shock Boot									SB112	
	ALL (Exc. Electronic Adj. Susp.)										SB101
	ALL w/ Electronic Adj. Susp.										SB112

Notes de bas de Page 320 - Guia de notas al calce del catalogo Pg. 321  
 Bold part numbers indicate the most comparable KYB product to the original design & performance.  
 (22) For vehicles with Electronic Susp., Leveling Control, and Air Suspensions refer to Appendix C.

# Applications For Pass. Cars, Light Trucks, SUV's, & Vans

VEHICLE MAKE, MODEL & YEAR	<b>GR-2</b>	<b>Gas-a-Just</b>	<b>MonoMax</b> 56XXXX Series	STRUT & SHOCK	
MARQUE, MODELE ET	<b>Excel-G</b>		<b>AGX</b> 7XXXXX Series	MOUNTS	BOOT KITS
ANNEE DU VEHICULE	 	 	 	 	 
LA MARCA EL MODELO & AÑO					

## BMW 850 Series

1991-97	ALL ALL (Exc. Electronic Adj. Susp.) ALL w/ Electronic Adj. Susp.								SB112	SB101 SB112
---------	---	--	--	--	--	--	--	--	-------	----------------

## BMW M3 Series

2001-03	M3 (E46)							SM5257	SB112	SB107
1995-99	M3 (E36)	Right Hand Left Hand						SM5258 SM5259	SM5013 SM5013	SB103 SB107
1988-91	M3 (E30)		364021 <sup>1</sup>		KG4539			SM5053	SM5013	

## BMW M5 Series

2000-03	M5 (E39) M5 (E39) w/ M Susp.							SM5261	SM5250	SB112	SB101
---------	---------------------------------	--	--	--	--	--	--	--------	--------	-------	-------

## BMW X3

2009	Strut Mount							SM5260			
2004-08	ALL	NA	344487					SM5260			

## BMW X5

2000-06	ALL (Exc. 4.8L)	Right Hand Left Hand	335924 335925		555610 555610			SM5254 SM5254 SM5342	SM5253 SM5253	SB112 SB112	SB107 SB107
	Upper Spring Seat Insulator										

## BMW Z Series

2006-08	ALL E85 / E86 w/ Sport Susp. ALL E85 / E86 w/o Sport Susp.									SB129 SB101	
2003-05	Z4								SM5257		SB108
2000-03	Z8							SM5261		SB104	SB108
1998-02	Z3 (Exc. Sport Susp.)	Right Hand Left Hand	334604 334605	343330 343330				SM5255 SM5255	SM5257 SM5257	SB110 SB110	
1996-97	Z3 (Exc. Sport Susp.)	Right Hand Left Hand	334604 334605	343330 343330				SM5255 SM5255	SM5013 SM5013	SB110 SB110	

## BRICKLIN SV-1

1974-76	ALL		343146	343219	KG4517	KG5517					
---------	-----	--	--------	--------	--------	--------	--	--	--	--	--

## BUICK Allure (Canadian Vehicle)

2007-08	ALL	Right Hand Left Hand						SM5143 SM5143	SM5399 SM5398 SM5394	SB127 SB127	SB128 SB128
	Universal Strut Mount w/ Boot Upper Spring Seat w/ Insulator Upper Spring Seat Insulator							SM5470 SM5467			
2005-06	ALL	Right Hand Left Hand	334227 334227	334228 334228				SM5143 SM5143	SM5399 SM5398 SM5394	SB127 SB127	SB128 SB128
	Universal Strut Mount w/ Boot Upper Spring Seat w/ Insulator Upper Spring Seat Insulator							SM5470 SM5467			

## BUICK Apollo

1974-75	ALL		343127	343132	KG4515	KG5506					
1973	ALL (Exc. HD Susp.) w/ HD Susp.		343127 343127	343132 343157	KG4515 KG4515	KG5504					

<sup>1</sup> The original High Pressure Gas Strut Cartridge can be replaced by [364021] with Boot Kit # [SB101]

Notes de bas de Page 320 - Guia de notas al calce del catalogo Pg. 321

Bold part numbers indicate the most comparable KYB product to the original design & performance.  
(22) For vehicles with Electronic Susp., Leveling Control, and Air Suspensions refer to Appendix C.

# Applications For Pass. Cars, Light Trucks, SUV's, & Vans

VEHICLE MAKE, MODEL & YEAR		<b>GR-2</b>		<b>Gas-a-Just</b>		<b>MonoMax</b> 56XXXX Series		STRUT & SHOCK			
MARQUE, MODELE ET		<b>Excel-G</b>				<b>AGX</b> 7XXXXX Series		MOUNTS		BOOT KITS	
ANNEE DU VEHICULE											
LA MARCA EL MODELO & AÑO											

## BUICK Centurion

1971-73	ALL	343127	343130								
---------	-----	--------	--------	--	--	--	--	--	--	--	--

## BUICK Century (also see STRUT-PLUS)

1997-05	ALL	Right Hand Left Hand	334227 334227	334228 334228			734058 734058	734059 734059	SM5143 SM5143	SM5399 SM5398 SM5394	SB127 SB127	SB128 SB128
			Universal Strut Mount w/ Boot Upper Spring Seat w/ Insulator Upper Spring Seat Insulator Lower Spring Seat Insulator						SM5470 SM5467 SM5437	SM5440		
1990-96	ALL		234019	343160		KG5555			SM5043 SM5229	SM5010	SB104	
			Spring Seat w/ Insulator									
1985-89	ALL		234019	343160		KG5555			SM5056 SM5229	SM5010	SB104	
			Spring Seat w/ Insulator									
1984	ALL w/ HD Susp.		234019	343160		KG5555			SM5056	SM5010	SB104	
1982-84	ALL (Exc. 84 HD Susp.) Spring Seat w/ Insulator		234002	343160		KG5555			SM5056 SM5229	SM5010	SB104	
1978-81	ALL		343127	343157	KG4513	KG5548						
1973-77	Sedan & Coupe Station Wagon		343127 343127	343157 343157	KG4513 KG4513	KG5504						

## BUICK Century - STRUT-PLUS

1997-05	ALL	Right Hand Left Hand	SR4002 SR4002	SR4003 SR4004								
---------	-----	-------------------------	------------------	------------------	--	--	--	--	--	--	--	--

## BUICK Electra (also see STRUT-PLUS)

1987-90	Sedan & Coupe Sedan & Coupe (For Adapting Air Shock / Strut to Non-Air Suspension) Sedan & Coupe Strut Mount Bearing Mount Insulator & Bearing Upper Spring Seat w/ Insulator Lower Spring Seat Insulator		236002	SR1003 SR4023 <sup>21</sup>					SM5281 SM5284	SM5017	SB105	
			SM5026 SM5350 SM5411									
1985-86	Sedan & Coupe Lower Spring Seat Insulator		236002	235025 <sup>21</sup>					SM5281 SM5411	SM5017	SB105	
1977-84	Sedan, Coupe, Convertible & Hardtop		343127	343130	KG4515	KG5507						
1971-76	Sedan, Coupe & Hardtop		343127	343130	KG4515	KG5507						
1970	Sedan, Coupe, Convertible & Hardtop					KG5508						
1965-69	ALL					KG5508						

## BUICK Electra - STRUT-PLUS

1987-90	ALL w/ FWD			NA <sup>60</sup>								
1985-86	ALL w/ FWD			NA <sup>60</sup>								

## BUICK Enclave

2008-10	Strut Boot										SB101	
---------	------------	--	--	--	--	--	--	--	--	--	-------	--

## BUICK Estate Wagon (RWD)













1977-90	ALL		343127	343157	KG4515	KG5504						
1971-76	ALL		343127	343157	KG4515							
1970	ALL			343130		KG5507						

<sup>21</sup> To replace the Original Equipment self-leveling air strut: use KYB gas strut # [235025] with Strut Boot Kit # [SB128]. Deactivate the self-leveling system per Appendix B.

<sup>60</sup> To eliminate the Original Equipment Air Strut, Use STRUT PLUS [SR4023]



# Applications For Pass. Cars, Light Trucks, SUV's, & Vans

VEHICLE MAKE, MODEL & YEAR	  	STRUT & SHOCK		BOOT KITS	
MARQUE, MODELE ET		MOUNTS			
ANNEE DU VEHICULE					
LA MARCA EL MODELO & AÑO					
	 	 	 	 	 

## BUICK LeSabre - STRUT-PLUS

1991-99	ALL (For Adapting Air Shock / Strut to Non-Air Suspension) ALL w/o Self Leveling Rear	SR4022	SR4023							
		SR4022	SR4023							
1990	Late Design Front Struts (w/o SpringGuard) w/ Self-Level Rear Late Design Front Struts (w/o SpringGuard) w/o Self-Level Rear Early Design Front Struts (w/ Spring Guard) w/ Self-leveling Rear w/o Self-leveling Rear	SR4022	NA <sup>60</sup>							
		SR4022	SR4023							
			NA <sup>60</sup>							
			SR4023							
1987-89	ALL w/ Self Leveling Rear ALL w/o Self Leveling Rear		NA <sup>60</sup>							
			SR4023							
1986	ALL w/ Self Leveling Rear ALL w/o Self Leveling Rear		NA <sup>60</sup>							
			SR4023							

## BUICK Lucerne

2006-10	ALL Upper Spring Seat Insulator							SM5467	SM5334	SB103
2006-09	ALL w/o Magnetic Ride Control	335065	SR1002 <sup>16</sup>							

## BUICK Park Avenue (Exc. Electronic Susp.)(also see STRUT-PLUS)

2002-05	ALL Upper Spring Seat w/ Insulator Lower Spring Seat Insulator	335045	SR1002 <sup>16</sup>					SM5276 SM5435 SM5437	SM5334	SB101
1998-01	ALL w/ Self Leveling Rear Upper Spring Seat w/ Insulator Lower Spring Seat Insulator	335045	SR1002 <sup>16</sup>					SM5276 SM5436 SM5437	SM5334	SB101
1997	ALL w/ Self Leveling Rear Lower Spring Seat Insulator	334677	SR1002 <sup>16</sup>					SM5437		SB101
1991-96	ALL ALL (For Adapting Air Shock / Strut to Non-Air Suspension) Strut Mount Bearing Spring Seat w/ Insulator Lower Spring Seat Insulator	236007	SR1003 <sup>17</sup> SR4023					SM5057  SM5284 SM5230 SM5412	SM5017	SB104

## BUICK Park Avenue (Exc. Elect. Adj. Susp.) - STRUT-PLUS

1991-96	ALL	SR4022	NA							
---------	-----	--------	----	--	--	--	--	--	--	--

## BUICK Rainier

2004-07	ALL Mount w/ Spring Insulator Lower Spring Seat Insulator	331043 <sup>81</sup>	343395		KG4162					SM5395 SM5548	SB108
---------	---	----------------------	--------	--	--------	--	--	--	--	------------------	-------

## BUICK Reatta

1990-91	Strut Mounting Kit Strut Mount Bearing							SM5279 SM5284	SM5275		
1988	ALL	236004						SM5114	SM5275	SB105	

## BUICK Regal (also see STRUT-PLUS)

1997-04	ALL	Right Hand Left Hand	334227 334227	334228 334228			734058 734058	734059 734059	SM5143 SM5143	SM5399 SM5398 SM5394	SB127 SB127	SB128 SB128
	Universal Strut Mount w/ Boot Upper Spring Seat w/ Insulator Upper Spring Seat Insulator								SM5470 SM5467			

<sup>16</sup> Box contains two shocks













<sup>17</sup> Air Strut: A Coil Spring Compressor is not needed

<sup>60</sup> To eliminate the Original Equipment Air Strut, Use STRUT PLUS [SR4023]

<sup>81</sup> Replaces [331016], when stock is depleted



# Applications For Pass. Cars, Light Trucks, SUV's, & Vans

VEHICLE MAKE, MODEL & YEAR	  	STRUT & SHOCK		BOOT KITS	
MARQUE, MODELE ET		MOUNTS			
ANNEE DU VEHICULE					
LA MARCA EL MODELO & AÑO					
	 	 	 	 	 

## BUICK Regal (also see STRUT-PLUS) (continued)

1990-96	ALL (FWD) w/ HD Susp. ALL (FWD) w/ Std. Susp.	366004 <sup>20</sup> 366004 <sup>20</sup>	236003 236003				SM5030 SM5029	SM5016 SM5016	SB104 SB104	SB106 SB106
1988-96	Strut Mount Bearing Strut Mounting Kit Lower Spring Seat w/ Bearing & Insulator Right Hand Left Hand Lower Spring Seat w/ Insulator Right Hand Left Hand						SM5083  SM5384 SM5383 SM5226 SM5225	SM5277		
1988-89	ALL (FWD) w/ HD Susp. ALL (FWD) w/ Std. Susp.	366004 <sup>20</sup> 366004 <sup>20</sup>	236003 236003				SM5031 SM5025	SM5016 SM5016	SB104 SB104	SB106 SB106
1984-87	Grand National & GNX			KG4513	KG5548					
1978-87	ALL (Exc. Grand National)	343127	343157	KG4513	KG5548					
1973-77	ALL	343127	343157	KG4513	KG5504					

## BUICK Regal - STRUT-PLUS

1997-04	ALL Right Hand Left Hand	SR4002 SR4002	SR4003 SR4004							
1990-96	ALL (FWD) w/ HD Susp. ALL (FWD) w/ Std. Susp.		SR4026 SR4026							
1988-89	ALL (FWD) w/ HD Susp. ALL (FWD) w/ Std. Susp.		SR4026 SR4026							

## BUICK Rendezvous

2002-07	ALL (Exc. Automatic Rear Air Leveling System) ALL w/ Automatic Rear Air Leveling System Upper Spring Seat w/ Insulator Upper Spring Seat Insulator Lower Spring Seat Insulator	335044 335044	344438		KG5045		SM5143 SM5143 SM5470 SM5467 SM5437		SB127 SB127	
---------	--	------------------	--------	--	--------	--	--	--	----------------	--

## BUICK Riviera

1998-99	ALL	335045	SR1002 <sup>16</sup>				SM5276	SM5334	SB101	
1997	ALL Strut / Shock Mount Strut Mount Bearing Spring Seat w/ Insulator	334677	SR1002 <sup>16</sup>				SM5286 SM5284 SM5230	SM5334	SB101	
1995-96	ALL Strut Mount Bearing Spring Seat w/ Insulator Lower Spring Seat Insulator	236007	SR1002 <sup>16</sup>				SM5286 SM5284 SM5230 SM5412	SM5334	SB101	
1990-93	Strut Mounting Kit Strut Mount Bearing						SM5279 SM5284	SM5275		
1986-89	ALL	236004					SM5114	SM5275	SB105	
1979-85	ALL			KG4531	KG5573 <sup>25</sup>					
1971-78	ALL	343127	343130	KG4515	KG5507					
1963-65	ALL	343127		KG4550						

## BUICK Roadmaster

1991-96	Sedan Station Wagon	343127 343127	343130 343157	KG4515 KG4515	KG5507 KG5504					
---------	------------------------	------------------	------------------	------------------	------------------	--	--	--	--	--

<sup>16</sup> Box contains two shocks

<sup>20</sup> See Special Installation Instructions Appendix A.

<sup>25</sup> Eliminates OEM airshocks. See appendix B for special instructions.

# Applications For Pass. Cars, Light Trucks, SUV's, & Vans

VEHICLE MAKE, MODEL & YEAR	<i><b>GR-2</b></i>		<i><b>Gas-a-Just</b></i>		<i><b>MonoMax</b></i> 56XXXX Series		STRUT & SHOCK		BOOT KITS	
MARQUE, MODELE ET	<i><b>Excel-G</b></i>				<i><b>AGX</b></i>		MOUNTS			
ANNEE DU VEHICULE					7XXXXX Series					
LA MARCA EL MODELO & AÑO										

## BUICK Skyhawk

1987-89	ALL	Right Hand	231013	343177		KG4536			SM5007	SM5010	SB104	
		Left Hand	231014	343177		KG4536			SM5007	SM5010	SB104	
	Upper Spring Seat w/ Isolator											
1984-86	ALL w/ Sealed Struts	Right Hand	231013	343177		KG4536			SM5007	SM5010	SB104	
		Left Hand	231014	343177		KG4536			SM5007	SM5010	SB104	
	ALL w/ Rebuildable Struts		366003 <sup>18</sup>	343177		KG4536			SM5007	SM5010	SB104	
	Upper Spring Seat w/ Isolator											
1982-83	ALL		365038 <sup>18</sup>	343177		KG4536			SM5007		SB104	
	Upper Spring Seat w/ Isolator											
1975-80	ALL		343129	343132								

## BUICK Skylark (Exc. Electronic Suspension)

1995-98	ALL w/o Swaybar Bracket	Right Hand	235604	343402		KG4552			SM5142	SM5010	SB104	
		Left Hand	235605	343402		KG4552			SM5142	SM5010	SB104	
	ALL w/ Swaybar Bracket	Right Hand		343402		KG5576			SM5142	SM5010	SB104	
		Left Hand		343402		KG5576			SM5142	SM5010	SB104	
	Strut Mount Bearing											
	Upper Spring Seat w/ Insulator											
1992-94	ALL w/o Swaybar Bracket	Right Hand	235604	343177		KG4536			SM5073	SM5010	SB104	
		Left Hand	235605	343177		KG4536			SM5073	SM5010	SB104	
	ALL w/ Swaybar Bracket	Right Hand		343177		KG4536			SM5073	SM5010	SB104	
		Left Hand		343177		KG4536			SM5073	SM5010	SB104	
	Strut Mount Bearing											
	Upper Spring Seat w/ Isolator											

## BUICK Skylark

1987-91	ALL	Right Hand	231013	343177		KG4536			SM5007	SM5010	SB104	
		Left Hand	231014	343177		KG4536			SM5007	SM5010	SB104	
1986	ALL w/ Sealed Struts	Right Hand	231013	343177		KG4536			SM5007	SM5010	SB104	
		Left Hand	231014	343177		KG4536			SM5007	SM5010	SB104	
	ALL w/ Rebuildable Struts		366003 <sup>18</sup>	343177		KG4536			SM5007	SM5010	SB104	
1985	ALL w/ Insulator		234019	343160		KG5555			SM5056	SM5010	SB104	
	Upper Spring Seat w/ Isolator											
1984	ALL w/ HD Susp.		234019	343160		KG5555			SM5056	SM5010	SB104	
	ALL w/o HD Susp. w/ Insulator		234002	343160		KG5555			SM5056	SM5010	SB104	
1982-83	ALL		234002	343160		KG5555			SM5056	SM5010	SB104	
1980-81	ALL		234002	343160		KG5555					SB104	
1975-79	ALL		343127	343132	KG4515	KG5506						
1970-72	ALL		343127	343157	KG4513	KG5504						
1968-69	ALL (Exc. Sportwagon)		343127	343157	KG4513	KG5504						
1967	ALL (Exc. HD Susp. & Sportwagon)		343128	343130	KG4515	KG5507						
	ALL w/ HD Susp.		343128	343130	KG4515	KG5504						
1964-66	ALL (Exc. Sportwagon)		343128	343130	KG4515	KG5507						

## BUICK Somerset

1985-87	ALL w/ Sealed Struts	Right Hand	231013	343177		KG4536			SM5007	SM5010	SB104	
		Left Hand	231014	343177		KG4536			SM5007	SM5010	SB104	
	ALL w/ Rebuildable Struts		366003	343177		KG4536			SM5007	SM5010	SB104	
	Upper Spring Seat w/ Isolator											

<sup>18</sup> Strut must be cut to install cartridge. Check strut for a cut line groove (20mm from strut top). If no cut line groove is found, do not cut strut open as there are no threads inside. The complete strut must be replaced.

# Applications For Pass. Cars, Light Trucks, SUV's, & Vans

VEHICLE MAKE, MODEL & YEAR	<b>GR-2</b>		<b>Gas-a-Just</b>		<b>MonoMax</b> 56XXXX Series		STRUT & SHOCK			
MARQUE, MODELE ET	<b>Excel-G</b>				<b>AGX</b>		MOUNTS		BOOT KITS	
ANNEE DU VEHICULE					7XXXXX Series					
LA MARCA EL MODELO & AÑO										

## BUICK Special

1970-72	ALL	343127	343157	KG4513	KG5504						
1968-69	ALL (Exc. Sportwagon) Sportwagon	343127 343127	343157 343135	KG4513 KG4513	KG5504 KG5521						
1967	ALL (Exc. HD Susp. & Sportwagon) ALL w/ HD Susp.	343128 343128	343130 343130	KG4515 KG4515	KG5507 KG5504						
1964-67	Sportwagon	343128	343135	KG4515	KG5521						
1964-66	ALL (Exc. Sportwagon)	343128	343130	KG4515	KG5507						

## BUICK Sportwagon

1970-72	ALL	343127	343157	KG4513	KG5504						
1968-69	ALL	343127	343135	KG4513	KG5521						
1967	ALL	343128	343135		KG5521						
1964-66	ALL	343128	343135		KG5521						

## BUICK Terraza (AWD)

2005-06	ALL Upper Spring Seat w/ Insulator Upper Spring Seat Insulator Lower Spring Seat Insulator	335061						SM5143 SM5470 SM5467 SM5437		SB127	
---------	---	--------	--	--	--	--	--	--------------------------------------	--	-------	--

## BUICK Terraza (FWD)

2005-07	ALL (Exc. Self Leveling Rear) Upper Spring Seat Insulator Upper Spring Seat w/ Insulator Lower Spring Seat Insulator	335061	344338		KG54325			SM5143 SM5467 SM5470 SM5437	SM5549 SM5549	SB127	
---------	---	--------	--------	--	---------	--	--	--------------------------------------	------------------	-------	--

## CADILLAC Allante

1989-93	Strut Mount Kit (Exc. Electronic Adj. Susp.)							SM5279	SM5275		
1987-93	Strut Mount Bearing (Exc. Electronic Adj. Susp.)							SM5284			
1987-88	ALL	236004						SM5279	SM5275	SB105	

## CADILLAC Brougham (Exc. Electronic Susp.)

1987-92	ALL RWD (Exc. Limousine)	343127	343130	KG4515	KG5507						
---------	--------------------------	--------	--------	--------	--------	--	--	--	--	--	--

## CADILLAC CTS

2008-09	ALL w/ FE1 Susp.				553603						
2003-07	ALL w/ FE1 Susp.			551605	553603						
2003-04	Strut Boot									SB108	

## CADILLAC Calais













1971-76	ALL				KG5508						
---------	-----	--	--	--	--------	--	--	--	--	--	--

## CADILLAC Catera

2000-01	ALL	334903						SM5285	SM5287	SB101	
1997-99	ALL (Exc. Sport)	334903						SM5285	SM5287	SB101	

Notes de bas de Page 320 - Guia de notas al calce del catalogo Pg. 321  
 Bold part numbers indicate the most comparable KYB product to the original design & performance.  
 (22) For vehicles with Electronic Susp., Leveling Control, and Air Suspensions refer to Appendix C.

# Applications For Pass. Cars, Light Trucks, SUV's, & Vans

VEHICLE MAKE, MODEL & YEAR	  	STRUT & SHOCK		BOOT KITS	
MARQUE, MODELE ET		MOUNTS			
ANNEE DU VEHICULE					
LA MARCA EL MODELO & AÑO	 	 	 	 	 

## CADILLAC Cimarron

1986-88	ALL	Right Hand Left Hand	231013 231014	343177 343177		KG4536 KG4536			SM5007 SM5007	SM5010 SM5010	SB104 SB104	
1984-86	ALL w/ Rebuildable Struts		366003 <sup>18</sup>	343177		KG4536			SM5007	SM5010	SB104	
1984-85	ALL w/ Sealed Struts	Right Hand Left Hand	231013 231014	343177 343177		KG4536 KG4536			SM5007 SM5007	SM5010 SM5010	SB104 SB104	
1982-87	Upper Spring Seat w/ Isolator								SM5348			
1982-83	ALL		365038 <sup>18</sup>	343177		KG4536					SB104	

## CADILLAC Commercial Chassis

1975-84	ALL		NA	NA								
---------	-----	--	----	----	--	--	--	--	--	--	--	--

## CADILLAC DeVille (Exc. Adj. Susp.) (also see STRUT-PLUS)

2000-05	DeVille, DeVille DHS (Exc. Limo)		335037						SM5276	SM5334	SB103	
2000-04	Hearse & Limo Lower Spring Seat Insulator								SM5276 SM5437	SM5334		
1997-99	Limousine, Hearse Strut Mount Bearing								SM5282 SM5284			
1995-99	Concours Strut Mount Bearing								SM5282 SM5284			
1994-99	Deville								SM5282			
1991-93	ALL FWD w/ Self Leveling Rear ALL FWD w/o Self Leveling Rear Spring Seat w/ Insulator Lower Spring Seat Insulator		236007 236007	SR1003 <sup>17</sup> 235025					SM5057 SM5057 SM5230 SM5412	SM5017 SM5017	SB104 SB104	SB104
1987-99	Deville Strut Mount Bearing								SM5284			
1987-90	ALL FWD w/ Self Leveling Rear ALL FWD w/o Self Leveling Rear Strut Mounting Kit Strut Mount Bearing Upper Spring Seat w/ Isolator Lower Spring Seat Insulator		236002 236002	SR1003 <sup>17</sup> 235025					SM5026 SM5026 SM5281 SM5284 SM5350 SM5411	SM5017 SM5017	SB105 SB105	SB104
1985-95	Limousine w/ Rear Wheel Drive				KG4515	KG5507						
1985-86	ALL FWD w/ Self Leveling Rear ALL FWD w/o Self Leveling Rear Lower Spring Seat Insulator		236002 236002	235025					SM5281 SM5281 SM5411	SM5017 SM5017	SB105 SB105	SB104
1977-84	ALL RWD (Exc. Limousine) Limousine		343127	343130	KG4515 KG4515	KG5507						
1971-76	ALL (Exc. Commercial Chassis)					KG5508						
1956-60	ALL (Exc. Commercial Chassis)				KG4515							

## CADILLAC DeVille (Exc. Adj. Susp.) - STRUT-PLUS

1991-93	ALL FWD w/ Self Leveling Rear ALL FWD w/o Self Leveling Rear		SR4022 SR4022	SR4023								
1987-90	ALL FWD w/o Self Leveling Rear			SR4023								
1985-86	ALL FWD w/o Self Leveling Rear			SR4023								













## CADILLAC DTS (Exc. Adj. Susp.)

2006-10	ALL w/o FE1 Susp.									SM5334	SB101	
2006-09	ALL w/ Soft Ride Susp. (Exc. Limo, Hearse, Armoured Body)		335065	NA						SM5334	SB103	

<sup>17</sup> Air Strut: A Coil Spring Compressor is not needed

<sup>18</sup> Strut must be cut to install cartridge. Check strut for a cut line groove (20mm from strut top). If no cut line groove is found, do not cut strut open as there are no threads inside. The complete strut must be replaced.

# Applications For Pass. Cars, Light Trucks, SUV's, & Vans

VEHICLE MAKE, MODEL & YEAR	  	STRUT & SHOCK		BOOT KITS	
MARQUE, MODELE ET		MOUNTS			
ANNEE DU VEHICULE					
LA MARCA EL MODELO & AÑO					
	 	 	 	 	 

## CADILLAC Eldorado

1997-02	ETC w/ Self Leveling Rear	NA	NA							
1996	ETC w/ Self Leveling Rear Exc. ETC, w/ Self Leveling Rear	NA	NA							
1995	ALL w/ Self Leveling Rear	NA	NA							
1993-02	Strut Mounting Kit							SM5282		
1990-92	Strut Mounting Kit							SM5279	SM5275	
1987-02	Strut Mount Bearing							SM5284		
1987-89	ALL	236004						SM5279	SM5275	SB105
1986	ALL	236004						SM5114	SM5275	SB105
1979-85	ALL			KG4531	KG5573 <sup>25</sup>					
1971-78	ALL		343130	KG4501	KG5507					
1967-70	ALL			KG4501						

## CADILLAC Escalade

2008-09	ALL (Exc. Electronic Adj. Susp.)	341493		551121				SM5530		SB129
2002-06	ALL (Exc. Electronic & Premium Smooth Ride Susp.) ALL w/ Premium Smooth Susp.			KG54327	KG54341	565067	565103			
				KG54327		565067				
1999-00	ALL	344266	344263	KG5480	KG5479	565062	565061			

## CADILLAC Escalade - KYB Lift Kit Replacement Shocks

2002-04	ALL (Exc. Electronic & Premium Smooth Ride Susp.) Lift = 2.5-5"					565076				
1999-00	ALL Lift = 1-3"					565073	565074			

## CADILLAC Fleetwood (Exc. Electronic Susp.) (also see STRUT-PLUS)

1991-93	Sedan & Coupe (FWD) FWD (Exc. FE1, F41 ,FX3) Strut Mount Bearing FWD w/ Self Leveling Rear Upper Spring Seat w/ Insulator Lower Spring Seat Insulator	236007	SR1003 <sup>17</sup>					SM5057 SM5284	SM5017	SB104
								SM5230		
								SM5412		
1987-90	Sedan & Coupe (FWD) Mount Insulator & Bearing FWD w/ Self Leveling Rear Upper Spring Seat w/ Isolator Lower Spring Seat Insulator	236002	SR1003 <sup>17</sup>					SM5281 SM5026 SM5350	SM5017	SB105
								SM5411		
1985-86	Sedan & Coupe (FWD) Lower Spring Seat Insulator	236002						SM5281 SM5411	SM5017	SB105
1977-96	Sedan & Coupe (RWD)	343127	343130	KG4515	KG5507					
1977-84	Limousine			KG4515						
1956-60	ALL (Exc. Commercial Chassis)			KG4515						

## CADILLAC Fleetwood (Exc. Adj. Susp.) - STRUT-PLUS

1991-93	ALL FWD w/ Self Leveling Rear ALL FWD w/o Self Leveling Rear	SR4022 SR4022								
---------	---	------------------	--	--	--	--	--	--	--	--

## CADILLAC Fleetwood, Limousine - Steering Stabilizer

1977-95	Steering Stabilizer	SS10200								
---------	---------------------	---------	--	--	--	--	--	--	--	--

<sup>17</sup> Air Strut: A Coil Spring Compressor is not needed











<sup>25</sup> Eliminates OEM airshocks. See appendix B for special instructions.

Notes de bas de Page 320 - Guia de notas al calce del catalogo Pg. 321

Bold part numbers indicate the most comparable KYB product to the original design & performance.

(22) For vehicles with Electronic Susp., Leveling Control, and Air Suspensions refer to Appendix C.

# Applications For Pass. Cars, Light Trucks, SUV's, & Vans

VEHICLE MAKE, MODEL & YEAR	<b>GR-2</b>	<b>Gas-a-Just</b>	<b>MonoMax</b> 56XXXX Series	STRUT & SHOCK	
MARQUE, MODELE ET	<b>Excel-G</b>		<b>AGX</b> 7XXXX Series	MOUNTS	BOOT KITS
ANNEE DU VEHICULE	 	 	 	 	 
LA MARCA EL MODELO & AÑO					

## CADILLAC SRX

2004-09	ALL (Exc. Magnetic Ride Control)		NA	551608						SB108	
---------	----------------------------------	--	----	--------	--	--	--	--	--	-------	--

## CADILLAC STS

2005-09	V6 (Incl. AWD) (Exc. Electronic, Magnetic Ride Control Susp.)			551607	NA					SB108	
	V8 (Exc. Electronic, Magnetic Ride Control Susp.)			551606	NA					SB108	

## CADILLAC Seville

1998-04	ALL (Exc. Electronic Adj. Susp.)	339016	SR1002 <sup>16</sup>					SM5276	SM5334		
1997	ALL w/ Self Leveling Rear	NA	NA								
1996	ALL w/ Self Leveling Rear	NA	NA								
1995	ALL w/ Self Leveling Rear	NA	NA								
1993-97	Strut Mounting Kit							SM5282			
1990-92	Strut Mounting Kit							SM5279	SM5275		
1987-97	Strut Mount Bearing							SM5284			
1987-89	ALL	236004						SM5279	SM5275	SB105	
1986	ALL	236004						SM5114	SM5275	SB105	
1980-85	ALL			KG4531	KG5573 <sup>25</sup>						SB107
1975-79	ALL	343127	343132 <sup>25</sup>	KG4513	KG5506 <sup>25</sup>						

## CADILLAC XLR

2004-08	ALL	NA	NA								
---------	-----	----	----	--	--	--	--	--	--	--	--

## CHECKER Marathon

1974-82	ALL (Exc. Aerobus)			KG5404	KG5429						
---------	--------------------	--	--	--------	--------	--	--	--	--	--	--

## CHEVROLET Astro Mini-Van (2WD)

1996-05	ALL	344081	344082	KG5458	KG5459	565049	565050				
1990-95	ALL	344081	344082	KG5458	KG5459	565049	565050				
1985-89	ALL	344081	344082	KG5458	KG5459	565049	565050				
1985-05	ALL (Lowered 2" / 4")					565049	565037				

## CHEVROLET Astro Mini-Van (AWD)

1996-05	ALL	344266	344082	KG5480	KG5459	565062	565050				
1990-95	ALL	344266	344082	KG5480	KG5459	565062	565050				

## CHEVROLET Avalanche (2WD)

2007-09	1500 (Exc. Electronic Susp. and Premium Smooth Ride Susp.)	341493	345073	551121	555054			SM5530		SB129	
2002-06	1500 (Exc. Electronic Susp. and Premium Smooth Ride Susp.)	344381	344384	KG54327	KG54341	565067	565103				
	2500	344383	344437	KG54340	KG5041	565102	565103				

## CHEVROLET Avalanche (4WD)

2007-09	1500 (Exc. Electronic Susp. and Premium Smooth Ride Susp.)	341493	345073	551121	555054			SM5530		SB129	
2002-06	1500 (Exc. Premium Smooth Ride or Off-Road Chassis Susp.)	344381	344384	KG54327	KG54341	565067	565103				
	1500 w/ Off-Road Chassis Package	344381	344436	KG54327	KG5195	565067	565103				

<sup>16</sup> Box contains two shocks

<sup>25</sup> Eliminates OEM airshocks. See appendix B for special instructions.

Notes de bas de Page 320 - Guia de notas al calce del catalogo Pg. 321

Bold part numbers indicate the most comparable KYB product to the original design & performance.

(22) For vehicles with Electronic Susp., Leveling Control, and Air Suspensions refer to Appendix C.

# Applications For Pass. Cars, Light Trucks, SUV's, & Vans

VEHICLE MAKE, MODEL & YEAR	<b>GR-2</b>	<b>Gas-a-Just</b>	<b>MonoMax</b> 56XXXX Series	STRUT & SHOCK	
MARQUE, MODELE ET	<b>Excel-G</b>		<b>AGX</b> 7XXXX Series	MOUNTS	BOOT KITS
ANNEE DU VEHICULE					
LA MARCA EL MODELO & AÑO					

## CHEVROLET Avalanche (4WD) (continued)

2002-06	1500 w/ Premium Smooth Ride Susp. 2500	341343 344383	SR2003 344437	KG5040 KG54340	KG5041	565102					
---------	---	------------------	------------------	-------------------	--------	--------	--	--	--	--	--

## CHEVROLET Avalanche (4WD) (Exc. Electronic Ride Control) Lift Replacement Shocks

2002-06	1500 (Exc. Premium Smooth Ride Susp.) Lift = 2.5-5"					565076					
---------	---	--	--	--	--	--------	--	--	--	--	--

## CHEVROLET Aveo

2010	ALL	Right Hand						SM5451	SM5452	SB101	SB107
		Left Hand						SM5451	SM5452	SB101	SB107
2009	ALL	Right Hand	333417	343423				SM5451	SM5452	SB101	SB107
		Left Hand	333418	343423				SM5451	SM5452	SB101	SB107
2004-08	ALL	Right Hand	333417	343423				SM5451	SM5452	SB101	SB107
		Left Hand	333418	343423				SM5451	SM5452	SB101	SB107

## CHEVROLET Aveo5

2009	ALL	Right Hand	333417	343423							
		Left Hand	333418	343423							
2007-08	ALL	Right Hand	333417	343423				SM5451	SM5452	SB101	SB107
		Left Hand	333418	343423				SM5451	SM5452	SB101	SB107

## CHEVROLET Bel Air

1977-81	Station Wagon		343127	343157	KG4515	KG5504					
1971-81	Police Car & Taxi Sedan (Exc. Police Car & Taxi)		344081 343127	343130 343130	KG5458 KG4515	KG5507 KG5507					
1971-76	Station Wagon		343127	343157	KG4515						
1967-70	ALL		343128	343130	KG4515	KG5507					
1965-66	ALL (Exc. Wagon & w/o HD Susp.) ALL w/ HD Susp. Station Wagon		343128 343128 343128	343130 343130 343130	KG4515 KG4515 KG4515	KG5507					
1958-64	ALL (Exc. 58-60 Air Susp.)		343127	343130	KG4550	KG5507					
1955-57	ALL		343127	343149	KG4550	KG5522					













## CHEVROLET Beretta

1995-96	ALL w/o Swaybar Bracket	Right Hand	235604	343402		KG4552		SM5142	SM5010	SB104	
		Left Hand	235605	343402		KG4552		SM5142	SM5010	SB104	
	ALL w/ Swaybar Bracket Strut Mount Bearing Upper Spring Seat w/ Insulator Lower Spring Seat Insulator			343402		KG5576		SM5142	SM5010	SB104	
								SM5284			
								SM5228			
								SM5431			
1992-94	ALL w/o Swaybar Bracket	Right Hand	235604	343177		KG4536		SM5073	SM5010	SB104	
		Left Hand	235605	343177		KG4536		SM5073	SM5010	SB104	
	ALL w/ Swaybar Bracket Strut Mount Bearing Upper Spring Seat w/ Isolator Lower Spring Seat Insulator			343177		KG4536		SM5073	SM5010	SB104	
								SM5284			
								SM5349			
								SM5431			
1987-91	ALL	Right Hand	231013	343177		KG4536		SM5033	SM5010	SB104	
		Left Hand	231014	343177		KG4536		SM5033	SM5010	SB104	
	Upper Spring Seat w/ Isolator Lower Spring Seat Insulator							SM5348			
								SM5431			

Notes de bas de Page 320 - Guia de notas al calce del catalogo Pg. 321

Bold part numbers indicate the most comparable KYB product to the original design & performance.  
(22) For vehicles with Electronic Susp., Leveling Control, and Air Suspensions refer to Appendix C.

# Applications For Pass. Cars, Light Trucks, SUV's, & Vans

VEHICLE MAKE, MODEL & YEAR	  	STRUT & SHOCK		BOOT KITS	
MARQUE, MODELE ET		MOUNTS			
ANNEE DU VEHICULE					
LA MARCA EL MODELO & AÑO					
	 	 	 	 	 

## CHEVROLET Biscayne

1971-75	Police Car & Taxi Sedan (Exc. Police Car & Taxi) Station Wagon	344081 343127 343127	343130 343130 343157	KG5458 KG4515 KG4515	KG5507 KG5507 KG5507						
1967-70	ALL	343128	343130	KG4515	KG5507						
1965-66	ALL (Exc. Wagon & w/o HD Susp.) ALL w/ HD Susp. Station Wagon	343128 343128 343128	343130 343130 343130	KG4515 KG4515 KG4515	KG5507 KG5507 KG5507						
1958-64	ALL (Exc. 58-60 Air Susp.)	343127	343130	KG4550	KG5507						

## CHEVROLET Blazer - Full Size (2WD) (Exc. S-Series)

1973-82	ALL	344068	344072	KG5409	KG5415	565032	565036				
1969-72	w/ Coil Spring w/ Leaf Spring	344068 344068	344085	KG5409 KG5409	KG5416 KG5419	565032 565032	565037				

## CHEVROLET Blazer - Full Size (4WD) (Exc. S-Series)

1992-94	ALL (Incl. Z-71 Off Road Package)	344266	344263	KG5480	KG5479	565062	565061				
1985-91	w/ Dual Front Shocks-Inside Shock		344072	KG5477	KG5415	565039	565036				
1980-91	w/ Dual Front Shocks-Outside Shock	344067	344072	KG5408	KG5415	565031	565036				
1980-84	w/ Dual Front Shocks-Inside Shock	344075	344072	KG5430	KG5415	565039	565036				
1973-91	ALL (Exc. w/ Dual Front Shocks)	344067	344072	KG5408	KG5415	565031	565036				
1969-72	ALL	344067		KG5408	KG5417	565031					

## CHEVROLET Blazer - Full Size (4WD) Steering Stabilizers

1973-92	OEM Replacement Cylinder	SS10325									
---------	--------------------------	---------	--	--	--	--	--	--	--	--	--

## CHEVROLET Blazer - Full Size (4WD) (Exc. S-Series) Lift Replacement Shocks

1992-94	ALL (Incl. Z-71 Off Road Package) Lift = 1-3" for Edelbrock # 6360 Lift = 4-6" for Rancho # RS5244 Lift = 4-6" for Rancho # RS9244 Lift = 4-6" for Rancho # RSX17316 Lift = 4-6" for Edelbrock # 63003 Lift = 4-6" for Edelbrock # 6460 Lift = 4-6" for Rancho # RS5227 Lift = 4-6" for Rancho # RS9227 Lift = 4-6" for Rancho # RSX17315 Lift = 4-6"					565073 565086 565092 565092 565086	565074 565087 565087 565087 565087 565087				
---------	--	--	--	--	--	--	--	--	--	--	--

## CHEVROLET Blazer (S-Series), S10 Blazer (2WD)

2004-05	ALL	344040	344041	KG5450	KG5451	565046	565047				
1999-03	ALL (Exc V4A Xtreme Sport Appearance Pkg.) ALL w/ V4A Xtreme Sport Appearance Pkg.	344040 344040	344041	KG5450 KG5450	KG5451	565046	565047				
1995-98	ALL	344040	344041	KG5450	KG5451	565046	565047				
1983-03	ALL (Lowered 2" / 4")					565046	565064				
1983-94	ALL	344040	344041	KG5450	KG5451	565046	565047				









## CHEVROLET Blazer (S-Series), S10 Blazer (4WD & AWD)

1995-05	ALL (Exc. ZR2 Wide Stance Package) ALL w/ ZR2 Wide Stance Package	344042 344042	344041	KG5452 KG5452	KG5451	565048 565048	565047				
1983-94	ALL	344042	344041	KG5452	KG5451	565048	565047				

Notes de bas de Page 320 - Guia de notas al calce del catalogo Pg. 321  
 Bold part numbers indicate the most comparable KYB product to the original design & performance.  
 (22) For vehicles with Electronic Susp., Leveling Control, and Air Suspensions refer to Appendix C.



# Applications For Pass. Cars, Light Trucks, SUV's, & Vans

VEHICLE MAKE, MODEL & YEAR	<b>GR-2</b>	<b>Gas-a-Just</b>	<b>MonoMax</b> 56XXXX Series	STRUT & SHOCK	
MARQUE, MODELE ET	<b>Excel-G</b>		<b>AGX</b> 7XXXX Series	MOUNTS	BOOT KITS
ANNEE DU VEHICULE	 	 	 	 	 
LA MARCA EL MODELO & AÑO					

## CHEVROLET Brookwood

1971-72	ALL	343127	343157							
1969-70	ALL	343128	343130							

## CHEVROLET C & K Series Pickups (See Silverado)

		----	----							
--	--	------	------	--	--	--	--	--	--	--

## CHEVROLET Camaro, Z28, IROC

2010	ALL V6	Right Hand	334684 <sup>70</sup>	341681 <sup>70</sup>							
		Left Hand	334685 <sup>70</sup>	341681 <sup>70</sup>							
	SS	Right Hand	334686 <sup>70</sup>	341682 <sup>70</sup>							
		Left Hand	334687 <sup>70</sup>	341682 <sup>70</sup>							
1993-02	ALL V6	Right Hand	341356	343211	KG9310	KG5562	741034	743019	SM5119		SB103
		Left Hand	341356	343211	KG9310	KG5562	741034	743019	SM5118		SB103
	ALL V8	Right Hand	341356	343211	KG9310	KG5562	741034	743019	SM5119		SB103
		Left Hand	341356	343211	KG9310	KG5562	741034	743019	SM5118		SB103
1982-92	ALL	Right Hand	236001	343211		KG5562	735001	743019	SM5028		
		Left Hand	236001	343211		KG5562	735001	743019	SM5027		
1970-81	ALL		343128	343131	KG4515	KG5526					
1968-69	w/ Multi Leaf Spring		343127	343135	KG4515	KG5521					
	w/ Single Leaf Spring Shock (Sleeve) Adapter Kit		343127	343135 <sup>7</sup> KIT107	KG4515	KG5524					
1967	ALL Shock (Sleeve) Adapter Kit		343127	343135 <sup>7</sup> KIT107	KG4515	KG5524					

## CHEVROLET Caprice

1977-96	Station Wagon		343127	343157	KG4515	KG5504					
1971-96	Police Car & Taxi		344081	343130	KG5458	KG5507					
	Sedan & Coupe (Exc. Police & Taxi)		343127	343130	KG4515	KG5507					
1971-76	Station Wagon		343127	343157	KG4515						
1966-70	ALL		343128	343130	KG4515	KG5507					

## CHEVROLET Cavalier, Z24 (also see STRUT-PLUS)











1999-05	ALL Lower Spring Seat Insulator		334316	341244			734038	741061	SM5283 SM5418	SM5147	SB101
1995-98	ALL Strut Mount Bearing Upper Spring Seat w/ Insulator Lower Spring Seat Insulator		334316	341244			734038	741061	SM5142 SM5284 SM5419 SM5418	SM5147	SB101
1992-94	ALL	Right Hand	231013	343177		KG4536			SM5033	SM5010	SB103
		Left Hand	231014	343177		KG4536			SM5033	SM5010	SB103
1987-91	Upper Spring Seat w/ Isolator								SM5348		
	ALL	Right Hand	231013	343177		KG4536			SM5007	SM5010	SB104
1984-86	ALL w/ Sealed Struts	Right Hand	231013	343177		KG4536			SM5007	SM5010	SB104
		Left Hand	231014	343177		KG4536			SM5007	SM5010	SB104
1982-83	ALL (Exc. Sealed Struts) Upper Spring Seat w/ Isolator		366003 <sup>18</sup>	343177		KG4536			SM5007 SM5348	SM5010	SB104
	ALL Upper Spring Seat w/ Isolator		365038 <sup>18</sup>	343177		KG4536			SM5007 SM5348		SB104

<sup>18</sup> Strut must be cut to install cartridge. Check strut for a cut line groove (20mm from strut top). If no cut line groove is found, do not cut strut open as there are no threads inside. The complete strut must be replaced.

<sup>7</sup> Use Kit #107

<sup>70</sup> New Part Number, Available 2nd Quarter 2011

# Applications For Pass. Cars, Light Trucks, SUV's, & Vans

VEHICLE MAKE, MODEL & YEAR	<b>GR-2</b>	<b>Gas-a-Just</b>	<b>MonoMax</b> 56XXXX Series	STRUT & SHOCK			
MARQUE, MODELE ET	<b>Excel-G</b>		<b>AGX</b> 7XXXX Series	MOUNTS		BOOT KITS	
ANNEE DU VEHICULE	 	 	 	 	 		
LA MARCA EL MODELO & AÑO							

## CHEVROLET Cavalier - STRUT-PLUS

1999-05	ALL	SR4024	SR4025							
1995-98	ALL	SR4024	SR4025							

## CHEVROLET Celebrity

1990	ALL Spring Seat w/ Insulator	234019	343160		KG5555			SM5043 SM5229	SM5010	SB104	
1985-89	ALL Spring Seat w/ Insulator	234019	343160		KG5555			SM5056 SM5229	SM5010	SB104	
1984	ALL w/ HD Susp. ALL w/ Std. Susp. Spring Seat w/ Insulator	234019 234002	343160 343160		KG5555 KG5555			SM5056 SM5056 SM5229	SM5010 SM5010	SB104 SB104	
1982-83	ALL	234002	343160		KG5555			SM5056		SB104	

## CHEVROLET Chevelle

1973-77	Sedan & Coupe Station Wagon	343127 343127	343157 343157	KG4513 KG4513	KG5504						
1968-72	ALL	343127	343157	KG4513	KG5504						
1964-67	ALL	343128	343130	KG4515	KG5507						

## CHEVROLET Chevette

1976-87	ALL	343145	343147								
---------	-----	--------	--------	--	--	--	--	--	--	--	--

## CHEVROLET Chevy II

1968-69	ALL (Exc. HD Susp.) w/ HD Susp.	343127 343127	343132 343157	KG4515 KG4515	KG5506 KG5504						
1962-67	ALL Shock (Sleeve) Adapter Kit		343135 <sup>7</sup> KIT107								

## CHEVROLET Citation

1985	ALL Spring Seat w/ Insulator	234019	343160		KG5555			SM5056 SM5229	SM5010	SB104	
1984	ALL w/ Std. Susp. X11 & HD Susp. Spring Seat w/ Insulator	234002 234019	343160 343160		KG5555 KG5555			SM5056 SM5056 SM5229	SM5010 SM5010	SB104 SB104	
1982-83	ALL	234002	343160		KG5555			SM5056		SB104	
1980-81	ALL	234002	343160		KG5555					SB104	

## CHEVROLET Classic (also see STRUT-PLUS)

2004-05	ALL Lower Spring Seat Insulator	334229	334295			734056	734057	SM5146 SM5420	SM5145 SM5524	SB104	SB101
---------	------------------------------------	--------	--------	--	--	--------	--------	------------------	------------------	-------	-------

## CHEVROLET Classic - STRUT-PLUS

2004-05	ALL	SR4001	SR4037								
---------	-----	--------	--------	--	--	--	--	--	--	--	--

## CHEVROLET Cobalt

2010	ALL (Exc. SS 2.0L) ALL		349043					SM5513		SB101	
2005-09	ALL (Exc. SS 2.0L) ALL	Right Hand Left Hand	339084 339085	349043 349043				SM5513		SB101	

<sup>7</sup> Use Kit #107

# Applications For Pass. Cars, Light Trucks, SUV's, & Vans

VEHICLE MAKE, MODEL & YEAR	<b>GR-2</b>		<b>Gas-a-Just</b>		<b>MonoMax</b> 56XXXX Series		STRUT & SHOCK			
MARQUE, MODELE ET	<b>Excel-G</b>				<b>AGX</b> 7XXXX Series		MOUNTS		BOOT KITS	
ANNEE DU VEHICULE										
LA MARCA EL MODELO & AÑO										

## CHEVROLET Colorado (2WD)

2004-09	ALL w/ Off-Road Package	344465	344466	KG5781	KG5190						
	ALL w/o Off-Road Package	341374	344464		KG5191						
2004-07	Upper Spring Seat Insulator							SM5413			

## CHEVROLET Colorado (4WD)

2004-09	ALL w/ Off-Road Package	344465	344466	KG5781	KG5190						
	ALL w/o Off-Road Package			KG5781	KG5190						

## CHEVROLET Corsica

1995-96	ALL w/o Swaybar Bracket	Right Hand	235604	343402		KG4552			SM5142	SM5010	SB104
		Left Hand	235605	343402		KG4552			SM5142	SM5010	SB104
	ALL w/ Swaybar Bracket			343402		KG5576			SM5142	SM5010	SB104
	Upper Spring Seat w/ Insulator								SM5228		
1992-96	Strut Mount Bearing								SM5284		
1992-94	ALL w/o Swaybar Bracket	Right Hand	235604	343177		KG4536			SM5073	SM5010	SB104
		Left Hand	235605	343177		KG4536			SM5073	SM5010	SB104
	ALL w/ Swaybar Bracket			343177		KG4536			SM5073	SM5010	SB104
	Upper Spring Seat w/ Isolator								SM5349		
1987-91	ALL	Right Hand	231013	343177		KG4536			SM5033	SM5010	SB104
		Left Hand	231014	343177		KG4536			SM5033	SM5010	SB104
	Upper Spring Seat w/ Isolator								SM5348		

## CHEVROLET Corvair

1960-64	ALL	343127	343127	KG4550	KG4550						
---------	-----	--------	--------	--------	--------	--	--	--	--	--	--

## CHEVROLET Corvette

2005-10	ALL (w/o Electronic Susp., Magnetic Selective Ride)			555604	555609 <sup>70</sup>						
1997-04	ALL (Exc. Sport Susp., Electronic Susp., F55 Magnetic Selective Ride)			555604	555605 <sup>79</sup>						
	ALL w/ Sport Susp., (Exc Electronic Susp., F55 Magnetic Selective Ride)			555604	553602 <sup>80</sup>						
1990-96	ALL (For Adapting ERC to Non-ERC Suspension)			KG5570 <sup>c</sup>	KG5571 <sup>c</sup>						
1989-96	ALL (Exc. Electronic Susp.)			KG5570	KG5571						
1988	ALL			KG5569	KG5571						
1984-87	ALL			KG4537	KG5564						
1963-82	ALL	343127	343218	KG4550	KG5501						
1953-62	ALL		343211	KG4503	KG5562						

## CHEVROLET Del Ray

1958	ALL	343127	343130								
------	-----	--------	--------	--	--	--	--	--	--	--	--

## CHEVROLET El Camino

1978-87	ALL	343127	343157 <sup>25</sup>	KG4513	KG5548 <sup>25</sup>						
1968-77	ALL	343127	343157 <sup>25</sup>	KG4513	KG5504 <sup>25</sup>						
1959-67	ALL	343128	343130	KG4515	KG5507						

## CHEVROLET Equinox

2007-09	ALL (Exc. Sport)		345055		554353						
---------	------------------	--	--------	--	--------	--	--	--	--	--	--

<sup>25</sup> Eliminates OEM airshocks. See appendix B for special instructions.











<sup>70</sup> New Part Number, Available 2nd Quarter 2011

<sup>79</sup> When [555605] stock is depleted, use [555609]

<sup>80</sup> When [553602] stock is depleted, use [555609]

<sup>c</sup> To convert from Electronic Susp - See Appendix C

# Applications For Pass. Cars, Light Trucks, SUV's, & Vans

VEHICLE MAKE, MODEL & YEAR		<b>GR-2</b> <i>Excel-G</i>		<b>Gas-a-Just</b>		<b>MonoMax</b> 56XXXX Series <b>AGX</b> 7XXXXX Series		STRUT & SHOCK MOUNTS		BOOT KITS	
MARQUE, MODELE ET ANNEE DU VEHICULE		 		 		 		 		 	
LA MARCA EL MODELO & AÑO											

## CHEVROLET Equinox (continued)

2005-06	ALL	Right Hand Left Hand	339058 339057	345055 345055		554353 554353					SB102 SB102
	Lower Spring Seat Insulator								SM5550		

## CHEVROLET Express 1500 (Van)

2003-10	2WD AWD		344481 341343	344483 344483	KG5780 KG5040	KG5188 KG5188		565033 565033			
1996-02	ALL		344265	344273	KG5478	KG54100	565060	565033			

## CHEVROLET Express 2500 (Van)

2003-10	ALL (Exc. 7300 GVW)		349046	349009	554356	554348					
2003-07	ALL w/ 7300 GVW		344481	344273	KG5780	KG54100		565033			
1996-02	ALL		344265	344273	KG5478	KG54100	565060	565033			

## CHEVROLET Express 3500 (Van)

2006-10	ALL (Exc. Cutaway Chassis) Cutaway Chassis w/ Lowered rear Leaf Susp.		349046 349046	349009 344483	554356 554356	554348 KG5188					
2003-05	ALL w/ Dual Rear Wheels ALL w/ Single Rear Wheels		349046 349046	344273 344262	554356 554356	KG5188 KG5188		565033 565034			
1996-02	ALL w/ Dual Rear Wheels ALL w/ Single Rear Wheels		344265 344265	344273 344262	KG5478 KG5478	KG54100 KG54101	565060 565060	565033 565034			

## CHEVROLET G-Series (1/2 Ton) Van

1978-95	ALL		344068	344075	KG5409	KG5430	565032	565039			
1971-77	G10		344068		KG5409	KG5417	565032				
1967-70	G10			344085		KG5419		565037			
1964-66	G10					KG5416					

## CHEVROLET G-Series (3/4 Ton) Van

1978-95	ALL		344068	344075	KG5409	KG5430	565032	565039			
1971-77	ALL		344068		KG5409	KG5417	565032				
1967-70	ALL			344085		KG5419		565037			

## CHEVROLET G-Series (1 Ton) Van (Exc. Motorhome Chassis)

1993-96	G30 HD w/ Straight Front Axle Leaf Spring (P42, P62) G30 HD w/ Independent Front Coil Spring (P42, P62)		345030	344366 344366	KG6001A KG6412	KG5420 KG5420		565038 565038			
1978-95	G30 Series (Exc. Dual Rear wheels & G30 HD) G30 Series w/ Dual Rear wheels		344068 344068	344075	KG5409	KG5430 KG5488	565032 565032	565039			
1971-77	ALL		344068		KG5409	KG5417	565032				

## CHEVROLET HHR

2010	LS & LT Models	Right Hand Left Hand	339084 339085	349043 349043							
2006-09	LS & LT Models	Right Hand Left Hand	339084 339085	349043 349043				SM5513 SM5513		SB101 SB101	

Notes de bas de Page 320 - Guia de notas al calce del catalogo Pg. 321  
 Bold part numbers indicate the most comparable KYB product to the original design & performance.  
 (22) For vehicles with Electronic Susp., Leveling Control, and Air Suspensions refer to Appendix C.

# Applications For Pass. Cars, Light Trucks, SUV's, & Vans

VEHICLE MAKE, MODEL & YEAR	<b>GR-2</b>	<b>Gas-a-Just</b>	<b>MonoMax</b> 56XXXX Series	STRUT & SHOCK			
MARQUE, MODELE ET	<b>Excel-G</b>		<b>AGX</b> 7XXXX Series	MOUNTS		BOOT KITS	
ANNEE DU VEHICULE							
LA MARCA EL MODELO & AÑO							

## CHEVROLET Impala (also see STRUT-PLUS)

2010	ALL (Exc. Police Car & Taxi)	Right Hand Left Hand	339015 339015	334228 334228					SM5143 SM5143	SM5399 SM5398	SB127 SB127	SB128 SB128
2006-10	Universal Strut Mount w/ Boot Upper Spring Seat w/ Insulator Upper Spring Seat Insulator Lower Spring Seat Insulator								SM5470 SM5467 SM5437	SM5394 SM5440		
2006-09	ALL (Exc. Models w/ 17" & 18" Wheels, Police, Taxi)	Right Hand Left Hand	339015 339015	334228 334228					SM5143 SM5143	SM5399 SM5398	SB127 SB127	SB128 SB128
	ALL w/ 17" or 18" Wheels	Right Hand Left Hand	339015 339015	339148 339148					SM5143 SM5143	SM5399 SM5398	SB127 SB127	SB128 SB128
2004-05	ALL (Exc. Police, Taxi & Special Handling Package)	Right Hand Left Hand	334227 334227	334228 334228		734058 734058	734059 734059		SM5143 SM5143	SM5399 SM5398	SB127 SB127	SB128 SB128
	ALL w/ Special Handling Suspension	Right Hand Left Hand	334227 334227	339148 339148		734058 734058	734059 734059		SM5143 SM5143	SM5399 SM5398 SM5394	SB127 SB127	SB128 SB128
	Universal Strut Mount w/ Boot Upper Spring Seat w/ Insulator Upper Spring Seat Insulator Lower Spring Seat Insulator								SM5470 SM5467 SM5437	SM5440		
2000-03	ALL	Right Hand Left Hand	334227 334227	334228 334228		734058 734058	734059 734059		SM5143 SM5143	SM5399 SM5398 SM5394	SB127 SB127	SB128 SB128
	Universal Strut Mount w/ Boot Upper Spring Seat w/ Insulator Upper Spring Seat Insulator Lower Spring Seat Insulator								SM5470 SM5467 SM5437	SM5440		
1994-96	SS		344081	343130	KG5458	KG5507						
1977-85	Station Wagon		343127	343157	KG4515	KG5504						
1971-85	ALL (Exc. Wagon, Police Car & Taxi) Police Car & Taxi		343127 344081	343130 343130	KG4515 KG5458	KG5507 KG5507						
1971-76	Station Wagon		343127	343157	KG4515							
1965-70	ALL		343128	343130	KG4515	KG5507						
1959-64	ALL (Exc. 58-60 Air Susp.)		343127	343130	KG4550	KG5507						

## CHEVROLET Impala - STRUT-PLUS

2004-06	ALL (Exc. Police, Taxi & Special Handling Package)		SR4002									
2001-03	3.4L (Exc. Police, Taxi & Special Handling Package)		SR4002									
	3.8L (Exc. Police, Taxi & Special Handling Package)	Right Hand Left Hand	SR4002 SR4002	SR4003 SR4004								
2000	ALL (Exc. Police, Taxi & Special Handling Package)		SR4002									

## CHEVROLET Kingswood













1971-72	ALL		343127	343157								
1969-70	ALL		343128	343130								

## CHEVROLET Laguna

1973-76	Sedan & Coupe		343127	343157	KG4513	KG5504						
1973	Station Wagon		343127	343157	KG4513							

Notes de bas de Page 320 - Guia de notas al calce del catalogo Pg. 321  
 Bold part numbers indicate the most comparable KYB product to the original design & performance.  
 (22) For vehicles with Electronic Susp., Leveling Control, and Air Suspensions refer to Appendix C.

# Applications For Pass. Cars, Light Trucks, SUV's, & Vans

VEHICLE MAKE, MODEL & YEAR	  	STRUT & SHOCK		BOOT KITS	
MARQUE, MODELE ET		MOUNTS			
ANNEE DU VEHICULE					
LA MARCA EL MODELO & AÑO					
	 	 	 	 	 

## CHEVROLET Lumina (Exc. APV) (also see STRUT-PLUS)

2000-01	ALL	Right Hand Left Hand	366004 <sup>20</sup> 366004 <sup>20</sup>	335014 335014					SM5143 SM5143	SM5397 SM5396	SB104 SB104	SB104 SB104
	Lower Spring Seat w/ Bearing & Insulator	Right Hand Left Hand							SM5384 SM5383			
1995-01	Universal Strut Mount Universal Strut Mount w/ Boot									SM5117 SM5393		
1995-99	ALL w/ HD Susp.	Right Hand Left Hand	366004 <sup>20</sup> 366004 <sup>20</sup>	335014 335014					SM5030 SM5030	SM5397 SM5396	SB104 SB104	SB104 SB104
	ALL w/ Std. Susp.	Right Hand Left Hand	366004 <sup>20</sup> 366004 <sup>20</sup>	335014 335014					SM5029 SM5029	SM5397 SM5396	SB104 SB104	SB104 SB104
1990-99	Strut Mount Bearing Lower Spring Seat w/ Insulator	Right Hand Left Hand							SM5083 SM5226 SM5225			
1990-94	90 Late Prod. w/ HD Susp. (10mm X 1.25 Studs on Front Upper Retainer)		366004 <sup>20</sup>	236003					SM5030	SM5016	SB104	SB106
	90 Late Prod. w/ Std. Susp. (10mm X 1.25 Studs on Front Upper Retainer)		366004 <sup>20</sup>	236003					SM5029	SM5016	SB104	SB106
1990	90 Early Prod. w/ H.D. Susp. (8mm X 1.25 Studs on Front Upper Retainer)		366004 <sup>20</sup>	236003					SM5031	SM5016	SB104	SB106
	90 Early Prod. w/ Std. Susp. (8mm X 1.25 Studs on Front Upper Retainer)		366004 <sup>20</sup>	236003					SM5025	SM5016	SB104	SB106

## CHEVROLET Lumina (Exc. APV) - STRUT-PLUS

1990-94	90 Late Prod. w/ HD Susp. (10mm X 1.25 Studs on Front Upper Retainer)			SR4026								
	90 Late Prod. w/ Std. Susp. (10mm X 1.25 Studs on Front Upper Retainer)			SR4026								
1990	90 Early Prod. w/ H.D. Susp. (8mm X 1.25 Studs on Front Upper Retainer)			SR4026								
	90 Early Prod. w/ Std. Susp. (8mm X 1.25 Studs on Front Upper Retainer)			SR4026								

## CHEVROLET Lumina APV Mini-Van (Footnote # 22)

1994-96	ALL w/o Rear Level Control Spring Seat w/ Insulator			343160		KG5555			SM5043 SM5229	SM5010	SB104	
1990-93	ALL w/ Rear Level Control ALL w/o Rear Level Control Spring Seat w/ Insulator		234019 234019	343160 <sup>22</sup> 343160		KG5555 <sup>22</sup> KG5555			SM5043 SM5043 SM5229	SM5010 SM5010	SB104 SB104	

## CHEVROLET Luv

1980-82	2WD 4WD		344043 344427	344045 344044	KG5446 KG5444	KG5438 KG5445	565045					
1972-79	ALL (Exc. Camper Model)			344044	KG4613A	KG4012						

## CHEVROLET Luv - Lift Replacement Shocks

1980-82	2WD Lift = 0-2"						565083					
---------	-----------------	--	--	--	--	--	--------	--	--	--	--	--

## CHEVROLET Malibu (Exc. Maxx) (also see STRUT-PLUS)

2010	ALL	Right Hand Left Hand	339051 339052	349008 349008					SM5471 SM5447	SM5476 SM5476	SB101 SB101	
2008-09	ALL (Exc. Classic)	Right Hand Left Hand	339051 339052	349008 349008					SM5471 SM5447	SM5476 SM5476	SB101 SB101	

<sup>20</sup> See Special Installation Instructions Appendix A.

<sup>22</sup> For vehicles with Electronic Susp., Leveling Control, and Air Suspensions refer to Appendix C.

# Applications For Pass. Cars, Light Trucks, SUV's, & Vans

VEHICLE MAKE, MODEL & YEAR	<b>GR-2</b>	<b>Gas-a-Just</b>	<b>MonoMax</b> 56XXXX Series	STRUT & SHOCK	
MARQUE, MODELE ET	<b>Excel-G</b>		<b>AGX</b> 7XXXX Series	MOUNTS	BOOT KITS
ANNEE DU VEHICULE					
LA MARCA EL MODELO & AÑO					

## CHEVROLET Malibu (Exc. Maxx) (also see STRUT-PLUS) (continued)

2008	Malibu Classic	Right Hand Left Hand Left Hand	339051 339052 339052	343454 343454 343454					SM5471 SM5447	SM5476 SM5476 SM5476	SB101 SB101	
2006-07	ALL (Exc. SS Model) SS	Right Hand Left Hand Right Hand Left Hand	339051 339052 339051 339052	343454 343454 343454 343454					SM5471 SM5447 SM5471 SM5447	SM5476 SM5476 SM5476 SM5476	SB101 SB101 SB101 SB101	
2004-05	ALL	Right Hand Left Hand	339051 339052	343454 343454					SM5471 SM5447	SM5476 SM5476	SB101 SB101	
1998-03	ALL w/ 2.50" Rear Strut Bolt Hole Spacing ( From Late 1998) Upper Spring Seat Insulator Lower Spring Seat Insulator		334229	334295			734056	734057	SM5146 SM5438 SM5420	SM5145 SM5524	SB104	SB101
1997-98	ALL w/ 3.25" Rear Strut Bolt Hole Spacing (To Early 1998) Upper Spring Seat Insulator Lower Spring Seat Insulator		334229	334230			734056		SM5146 SM5438 SM5420	SM5145 SM5524	SB104	SB101
1978-83	ALL		343127	343157	KG4513	KG5548						
1973-77	Sedan, Coupe & Convertible Station Wagon		343127 343127	343157 343157	KG4513 KG4513	KG5504						
1968-72	ALL		343127	343157	KG4513	KG5504						
1964-67	ALL		343128	343130	KG4515	KG5507						

## CHEVROLET Malibu (FWD) - STRUT-PLUS

1998-03	ALL w/ 2.50" Rear Strut Bolt Hole Spacing ( From Late 1998)		SR4001	SR4037								
1997-98	ALL w/ 3.25" Rear Strut Bolt Hole Spacing (To Early 1998)		SR4001									

## CHEVROLET Malibu Maxx

2007	ALL (Exc. LTZ) LTZ Models	Right Hand Left Hand Right Hand Left Hand	339051 339052 339051 339052	343454 343454 349008 349008					SM5471 SM5447 SM5471 SM5447	SM5476 SM5476 SM5476 SM5476	SB101 SB101 SB101 SB101	
2004-06	ALL	Right Hand Left Hand	339051 339052	343454 343454					SM5471 SM5447	SM5476 SM5476	SB101 SB101	

## CHEVROLET Metro (Also See GEO)

1998-01	ALL	Right Hand Left Hand	232025 232026						SM5188 SM5188	SM5189 SM5189	SB103 SB103	SB101 SB101
---------	-----	-------------------------	------------------	--	--	--	--	--	------------------	------------------	----------------	----------------













## CHEVROLET Monte Carlo (also see STRUT-PLUS)

2006-07	ALL (Exc. Models w/ 17" & 18" Wheels) ALL w/ 17" or 18" Wheels Universal Strut Mount w/ Boot Universal Strut Mount Upper Spring Seat w/ Insulator Upper Spring Seat Insulator Lower Spring Seat Insulator	Right Hand Left Hand Right Hand Left Hand	339015 339015 339015 339015	334228 334228 339148 339148					SM5143 SM5143 SM5143 SM5143	SM5399 SM5398 SM5399 SM5398 SM5394 SM5144	SB127 SB127 SB127 SB127	SB128 SB128 SB128 SB128
2004-05	ALL (Exc. Special Handling Pkg.)	Right Hand Left Hand	334227 334227	334228 334228			734058 734058	734059 734059	SM5143 SM5143	SM5399 SM5398	SB127 SB127	SB128 SB128

Notes de bas de Page 320 - Guia de notas al calce del catalogo Pg. 321

Bold part numbers indicate the most comparable KYB product to the original design & performance.  
(22) For vehicles with Electronic Susp., Leveling Control, and Air Suspensions refer to Appendix C.

# Applications For Pass. Cars, Light Trucks, SUV's, & Vans

VEHICLE MAKE, MODEL & YEAR	  	STRUT & SHOCK		BOOT KITS	
MARQUE, MODELE ET		MOUNTS			
ANNEE DU VEHICULE					
LA MARCA EL MODELO & AÑO					
	 	 	 	 	 

## CHEVROLET Monte Carlo (also see STRUT-PLUS) (continued)

	ALL w/ Special Handling Suspension											
	Right Hand	339015	339148					SM5143	SM5399	SB127	SB128	
	Left Hand	339015	339148					SM5143	SM5398	SB127	SB128	
	Universal Strut Mount w/ Boot								SM5394			
	Universal Strut Mount								SM5144			
	Upper Spring Seat w/ Insulator							SM5470				
	Upper Spring Seat Insulator							SM5467				
	Lower Spring Seat Insulator							SM5437	SM5440			
2000-03	ALL	Right Hand	334227	334228			734058	734059	SM5143	SM5399	SB127	SB128
	Left Hand	334227	334228			734058	734059	SM5143	SM5398	SB127	SB128	
	Universal Strut Mount w/ Boot								SM5394			
	Universal Strut Mount								SM5144			
	Upper Spring Seat w/ Insulator							SM5470				
	Upper Spring Seat Insulator							SM5467				
	Lower Spring Seat Insulator							SM5437	SM5440			
1995-99	ALL	Right Hand	366004 <sup>20</sup>	335014					SM5030	SM5397	SB104	SB128
	Left Hand	366004 <sup>20</sup>	335014						SM5030	SM5396	SB104	SB128
	Strut Mount Bearing								SM5083			
	Universal Strut Mount w/ Boot									SM5393		
	Universal Strut Mount									SM5117		
	Lower Spring Seat w/ Bearing & Insulator											
	Right Hand								SM5384			
	Left Hand								SM5383			
1978-88	ALL		343127	343157	KG4513	KG5548						
1970-77	ALL		343127	343157	KG4513	KG5504						

## CHEVROLET Monte Carlo - STRUT-PLUS

2006	ALL (Exc. Special Handling Pkg.)										
	Right Hand	SR4002									
	Left Hand	SR4002									
2000-05	ALL (Exc. Special Handling Pkg.)										
	Right Hand	SR4002	SR4003								
	Left Hand	SR4002	SR4004								

## CHEVROLET Monza

1975-80	ALL (Incl. Station Wagon)	343129	343132								
---------	---------------------------	--------	--------	--	--	--	--	--	--	--	--

## CHEVROLET Nova

1988	Twin Cam	365041	232030						SM5069	SB101	SB102	
1985-88	ALL (Exc. Twin Cam)	Right Hand	234024	232028					SM5019	SM5069	SB101	SB102
	Left Hand	234025	232029						SM5019	SM5069	SB101	SB102
1974-79	ALL	343127	343132	KG4515	KG5506							
1968-73	ALL (Exc. HD Susp.)	343127	343132	KG4515	KG5506							
	w/ HD Susp.	343127	343157	KG4515	KG5504							
1962-67	ALL		343135 <sup>7</sup>									
	Shock (Sleeve) Adapter Kit		KIT107									

## CHEVROLET One-Fifty Series

1955-57	ALL	343127	343149								
---------	-----	--------	--------	--	--	--	--	--	--	--	--

## CHEVROLET P10













1974-84	ALL	344068	344366	KG5409	KG5420	565032	565038				
1973	ALL	344068	344072	KG5409	KG5415	565032	565036				
1967-72	ALL	344068		KG5409	KG5416	565032					
1963-66	ALL	344068	344085	KG5409	KG5419	565032	565037				

<sup>20</sup> See Special Installation Instructions Appendix A.

<sup>7</sup> Use Kit #107



# Applications For Pass. Cars, Light Trucks, SUV's, & Vans

VEHICLE MAKE, MODEL & YEAR	  	STRUT & SHOCK		BOOT KITS	
MARQUE, MODELE ET		MOUNTS			
ANNEE DU VEHICULE					
LA MARCA EL MODELO & AÑO					
	 	 	 	 	 

## CHEVROLET P20

1982-91	ALL	344068	344366	KG5409	KG5420	565032	565038				
1973-81	ALL	344068	344072	KG5409	KG5415	565032	565036				
1968-72	ALL	344068	344085	KG5409	KG5419	565032	565037				

## CHEVROLET P30 (Exc. Motorhome Chassis)

1985-01	ALL (Exc. Monobeam Front Susp. & Camper Conversion)	344068	344366	KG5409	KG5420	565032	565038				
	w/ Monobeam Front Susp., Including Camper Conversion	345030	344366	KG6001A	KG5420		565038				
	w/ Camper Conversion (Exc. Monobeam Front Susp.)		344366		KG5420		565038				
1973-84	ALL Incl. Camper Conversion	344068	344366	KG5409	KG5420	565032	565038				
1968-72	ALL (Exc. w/ 157" WB & 11,000lb. Axle)	344068	344085	KG5409	KG5419	565032	565037				
	w/ 157" WB & 11,000lb. Axle	344068		KG5409	KG5417	565032					

## CHEVROLET Prizm (Also See GEO)

1998-02	ALL	Right Hand	234057	234059					SM5049	SM5075	SB103	SB117
		Left Hand	234058	234060					SM5049	SM5074	SB103	SB117

## CHEVROLET S-Series Pickup (2WD)

1999-03	ALL (Exc V4A Xtreme Sport Appearance Pkg.)	344040	344041	KG5450	KG5451	565046	565047				
	ALL w/ V4A Xtreme Sport Appearance Pkg.	344040		KG5450							
1995-98	ALL	344040	344041	KG5450	KG5451	565046	565047				
1982-03	ALL (Lowered 2" / 4")					565046	565064				
1982-94	ALL	344040	344041	KG5450	KG5451	565046	565047				

## CHEVROLET S-Series Pickup (4WD)

1995-04	ALL (Exc. ZR2 Wide Stance Package)	344042	344041	KG5452	KG5451	565048	565047				
1995-03	ALL w/ ZR2 Wide Stance Package	344042		KG5452		565048					
1982-94	ALL	344042	344041	KG5452	KG5451	565048	565047				

## CHEVROLET S-Series Pickup, Blazer (4WD) - Lift Replacement Shocks

1982-05	ALL Lift = 0-2"					565075					
---------	-----------------	--	--	--	--	--------	--	--	--	--	--

## CHEVROLET SSR

2003-06	ALL Mount w/ Spring Insulator Lower Spring Seat Insulator	331043 <sup>81</sup>	343395		KG4162				SM5395 SM5548		SB108	
---------	---	----------------------	--------	--	--------	--	--	--	------------------	--	-------	--

## CHEVROLET Silverado, C & R - Series 1/2 Ton (2WD)













2010	Silverado 1500 (Exc. Classic Series, HD & Electronic Susp.)								SM5530		SB129	
2007-09	Silverado 1500 (Exc. Classic Series, HD & Electronic Susp.)	341493	345074	551121	555055				SM5530		SB129	
2007	Silverado Classic 1500 (Exc. Elec. Susp., QuadraSteer & HD)	344380	344365	KG54326	KG54104	565066	565016					
	Silverado 1500 Crew Cab Classic w/ Torsion Bar Front Susp. (Exc. Elec. Susp. & QuadraSteer)	344381	344386	KG54327	KG54341	565067	565103					
	Silverado 1500HD Crew Cab w/ Front Torsion Bar Susp. (Exc. Elec. Susp. & QuadraSteer)	344383	344385	KG54340	KG54342	565102	565104					

<sup>81</sup> Replaces [331016], when stock is depleted

Notes de bas de Page 320 - Guia de notas al calce del catalogo Pg. 321

Bold part numbers indicate the most comparable KYB product to the original design & performance.  
(22) For vehicles with Electronic Susp., Leveling Control, and Air Suspensions refer to Appendix C.

# Applications For Pass. Cars, Light Trucks, SUV's, & Vans

VEHICLE MAKE, MODEL & YEAR	  	STRUT & SHOCK		BOOT KITS	
MARQUE, MODELE ET		MOUNTS			
ANNEE DU VEHICULE					
LA MARCA EL MODELO & AÑO					
	 	 	 	 	 

## CHEVROLET Silverado, C & R - Series 1/2 Ton (2WD) (continued)







2007	Silverado 1500 Crew Cab Classic w/ Coil Spring Front Susp. (Exc. Elec. Susp.)	344402	344385	KG54339	KG54342	565101	565104				
2004-06	Silverado 1500 Crew Cab w/ Coil Spring Front Susp. (Exc. Elec. Susp. & QuadraSteer)	344402	344385	KG54339	KG54342	565101	565104				
2005-06	Silverado 1500HD Crew Cab (Exc. Elec. Susp. & QuadraSteer)	344383	344385	KG54340	KG54342	565102	565104				
2004-06	Silverado 1500 Crew Cab w/ Torsion Bar Front Susp. (Exc. Elec. Susp. & QuadraSteer)	344381	344386	KG54327	KG54341	565067	565103				
2001-03	Silverado 1500HD Crew Cab w/ Front Torsion Bar Susp. (Exc. Elec. Susp. & QuadraSteer)	344383	344385	KG54340	KG54342	565102	565104				
2001-02	Silverado 1500HD Crew Cab w/ Coil Spring Front Susp. (Exc. Elec. Suspension)	344402	344385	KG54339	KG54342	565101	565104				
1999-06	Silverado 1500 (Exc. HD, Crew Cab, Elec. Susp. & QuadraSteer)	344380	344365	KG54326	KG54104	565066	565016				
1988-99	C1500 C1500 (Lowered 2" / 4")	344265	344263	KG5478	KG5479	565060 565060	565061 565033				
1973-87	C10, R10	344068	344072	KG5409	KG5415	565032	565036				
1967-72	C10 w/ Coil Spring C10 w/ Leaf Spring	344068 344068	344085	KG5409 KG5409	KG5416 KG5419	565032 565032	565037				
1963-66	C10	344068	344085	KG5409	KG5419	565032	565037				

## CHEVROLET Silverado, K & V - Series 1/2 Ton (4WD)

2010	Silverado 1500 (Exc. Classic Series, HD & Electronic Susp.)							SM5530		SB129	
2007-09	Silverado 1500 (Exc. Classic Series, HD & Electronic Susp.)	341493	345074	551121	555055			SM5530		SB129	
2007	Silverado Classic 1500 (Exc. HD, Elec. Susp. & QuadraSteer) Silverado 1500 Classic w/ Z-71 Off Road Package	344381	344386	KG54327 KG54327	KG5482 KG5482	565067 565067	565068 565068				
2005-07	Silverado 1500HD Crew Cab (Incl. Classic) (Exc. Elec. Susp. & QuadraSteer)	344383	344385	KG54340	KG54342	565102	565104				
2001-03	Silverado 1500HD Crew Cab (Exc. Elec. Susp. & QuadraSteer)	344383	344385	KG54340	KG54342	565102	565104				
1999-06	Silverado 1500 (Exc. HD, Elec. Susp. & QuadraSteer) Silverado 1500 (w/ Z-71 Off Road Package)	344381	344386	KG54327 KG54327	KG5482 KG5482	565067 565067	565068 565068				
1988-99	K1500 (Exc. Z-71 Off Road Package) K1500 w/ Z-71 Off Road Package	344266	344263	KG5480 KG5480	KG5479 KG5479	565062 565062	565061 565061				
1985-91	ALL w/ Dual Front Shocks - inside shock ALL w/ Dual Front Shocks - outside shock		344072 344067	KG5477 KG5408	KG5415 KG5415	565039 565031	565036 565036				
1980-84	ALL w/ Dual Front Shocks - inside shock ALL w/ Dual Front Shocks - outside shock	344075 344067	344072 344072	KG5430 KG5408	KG5415 KG5415	565039 565031	565036 565036				
1973-87	K10, V10 (Exc. w/ Dual Front Shocks)	344067	344072	KG5408	KG5415	565031	565036				

Notes de bas de Page 320 - Guia de notas al calce del catalogo Pg. 321  
 Bold part numbers indicate the most comparable KYB product to the original design & performance.  
 (22) For vehicles with Electronic Susp., Leveling Control, and Air Suspensions refer to Appendix C.

# Applications For Pass. Cars, Light Trucks, SUV's, & Vans

VEHICLE MAKE, MODEL & YEAR		<b>GR-2</b>		<b>Gas-a-Just</b>		<b>MonoMax</b> 56XXXX Series		STRUT & SHOCK			
MARQUE, MODELE ET		<b>Excel-G</b>				<b>AGX</b> 7XXXXX Series		MOUNTS		BOOT KITS	
ANNEE DU VEHICULE		 		 		 		 		 	
LA MARCA EL MODELO & AÑO											

## CHEVROLET Silverado, K & V - Series 1/2 Ton (4WD) (continued)

1969-72	K10	344067		KG5408	KG5417	565031					
---------	-----	--------	--	--------	--------	--------	--	--	--	--	--

## CHEVROLET Silverado, K & V Series (1/2 Ton) (4WD) Steering Stabilizer

1988-05	Complete Kit	SS15326									
1988-98	w/ OE Unit (Cylinder only)	SS10317									
1973-87	OEM Replacement Cylinder	SS10325									

## CHEVROLET Silverado, C & R - Series 3/4 Ton (2WD)

2005-10	Silverado 2500HD	344383	344385	KG54340	KG54342	565102	565104				
2000-04	Silverado 2500HD (9200GVW)	344383	344385	KG54340	KG54342	565102	565104				
1999-04	Silverado 2500 (up to 8600 GVW) (Exc. Quadrasteer)	344402	344385	KG54339	KG54342	565101	565104				
1988-00	C2500 C2500 (Lowered 2" / 4")	344265	344263	KG5478	KG5479	565060 565060	565061 565033				
1988-90	R2500	344068	344072	KG5409	KG5415	565032	565036				
1987-88	R20 (Exc. Crew Cab) R20 Crew Cab	344068 344068	344072 344366	KG5409 KG5409	KG5415 KG5420	565032 565032	565036 565038				
1973-86	C20 (Exc. Crew Cab) C20 Crew Cab	344068 344068	344072 344366	KG5409 KG5409	KG5415 KG5420	565032 565032	565036 565038				
1967-72	C20 w/ Coil Spring C20 w/ Leaf Spring	344068 344068	344085	KG5409 KG5409	KG5416 KG5419	565032 565032	565037				
1963-66	C20	344068	344085	KG5409	KG5419	565032	565037				

## CHEVROLET Silverado, K & V - Series 3/4 Ton (4WD)













2005-10	Silverado 2500HD	344383	344385	KG54340	KG54342	565102	565104				
2000-04	Silverado 2500HD (9200GVW)	344383	344385	KG54340	KG54342	565102	565104				
1999-04	Silverado 2500 (up to 8600 GVW) (Exc. Quadrasteer)	344383	344385	KG54340	KG54342	565102	565104				
1988-00	K2500	344266	344263	KG5480	KG5479	565062	565061				
1985-91	ALL w/ Dual Front Shocks - inside shock ALL w/ Dual Front Shocks - outside shock		344072	KG5477	KG5415	565039	565036				
		344067	344072	KG5408	KG5415	565031	565036				
1980-84	ALL w/ Dual Front Shocks - inside shock ALL w/ Dual Front Shocks - outside shock	344075	344072	KG5430	KG5415	565039	565036				
		344067	344072	KG5408	KG5415	565031	565036				
1973-87	K20, V20 (Exc. w/ Dual Front Shocks)	344067	344072	KG5408	KG5415	565031	565036				
1969-72	K20	344067		KG5408	KG5417	565031					

## CHEVROLET Silverado, K & V Series (3/4 Ton) (4WD) Steering Stabilizer

2002-05	2500HD OEM Replacemant Cylinder	SS10318									
1988-04	Complete Kit	SS15326									
1988-98	w/ OE Unit (Cylinder only)	SS10317									
1973-87	OEM Replacement Cylinder	SS10325									

Notes de bas de Page 320 - Guia de notas al calce del catalogo Pg. 321  
 Bold part numbers indicate the most comparable KYB product to the original design & performance.  
 (22) For vehicles with Electronic Susp., Leveling Control, and Air Suspensions refer to Appendix C.

# Applications For Pass. Cars, Light Trucks, SUV's, & Vans

VEHICLE MAKE, MODEL & YEAR	  	STRUT & SHOCK		BOOT KITS	
MARQUE, MODELE ET		MOUNTS			
ANNEE DU VEHICULE					
LA MARCA EL MODELO & AÑO					
	 	 	 	 	 

## CHEVROLET Silverado, C & R - Series 1 Ton (2WD)

2007-10	Silverado 3500HD	344383	344384	KG54340	KG54341	565102	565103				
2001-07	Silverado 3500 (11400 GVW) w/ Ind. Front Susp. Inc. Classic	344383	344384	KG54340	KG54341	565102	565103				
1988-00	C3500 (Exc. HD Series)	344265	344263	KG5478	KG5479	565060	565061				
1988-99	C3500 (Lowered 2" / 4")					565060	565033				
1991-03	C3500 HD Series w/ I-Beam Front Axle		344263	KG54307	KG5479		565061				
1987-91	R30, R3500	344068	344366	KG5409	KG5420	565032	565038				
1973-86	C30	344068	344366	KG5409	KG5420	565032	565038				
1967-72	C30 (Exc. w/ 157" WB & 11,000lb. Axle)	344068	344085	KG5409	KG5419	565032	565037				
	C30 w/ 157" WB & 11,000lb. Axle	344068		KG5409	KG5417	565032					

## CHEVROLET Silverado, K & V - Series 1 Ton (4WD)

2007-10	Silverado 3500HD	344383	344384	KG54340	KG54341	565102	565103				
2001-07	Silverado 3500 (11400 GVW) (Incl. Chassis Cab & Classic)	344383	344384	KG54340	KG54341	565102	565103				
1989-91	V3500		344386	KG5481	KG5482	565069	565068				
1988-00	K3500	344266	344263	KG5480	KG5479	565062	565061				
1987-88	V30		344386	KG5481	KG5482	565069	565068				
1977-86	K30		344386	KG5481	KG5482	565069	565068				

## CHEVROLET Silverado, K & V Series (1 Ton) (4WD) Steering Stabilizer

1973-87	OEM Replacement Cylinder	SS10325									
---------	--------------------------	---------	--	--	--	--	--	--	--	--	--

## CHEVROLET K1500, K2500, K3500 (Exc. Suburban) - Lift Replacement Shocks

1988-99	K1500, K2500, K3500 Lift = 1-3" for Edelbrock # 6360 Lift = 4-6" for Rancho # RS5244 Lift = 4-6" for Rancho # RS9244 Lift = 4-6" for Rancho # RSX17316 Lift = 4-6" for Edelbrock # 63003 Lift = 4-6" for Edelbrock # 6460 Lift = 4-6" for Rancho # RS5227 Lift = 4-6" for Rancho # RS9227 Lift = 4-6" for Rancho # RSX17315 Lift = 4-6"					565073 565086 565092 565092 565086	565074				
							565087 565087 565087 565087 565087				

## CHEVROLET Silverado 1500 (4WD) (Incl. Crew Cab, Exc. 1500HD, QuadraSteer) - Lift Replacement Shocks

2007	Silverado Classic 1500 (Exc. HD, Elec. Susp. & QuadraSteer) Lift = 2.5-5" Silverado Classic 1500 (Exc. HD, Elec. Susp. & QuadraSteer) Lift = 2-3"					565076		565077			
1999-06	ALL Lift = 2.5-5" for Edelbrock # 63005 Lift = 4" for Edelbrock # 63008 Lift = 4" for Rancho # RS9268 Lift = 4" for Rancho # RSX17337 Lift = 4" ALL Lift = 2-3" for Edelbrock # 6405 Lift = 4" for Edelbrock # 6408 Lift = 4" for Rancho # RS9269 Lift = 4" for Rancho # RSX17338 Lift = 4"					565076 565076 565076 565076 565076		565077 565095 565095 565095 565095			

Notes de bas de Page 320 - Guia de notas al calce del catalogo Pg. 321

Bold part numbers indicate the most comparable KYB product to the original design & performance.  
(22) For vehicles with Electronic Susp., Leveling Control, and Air Suspensions refer to Appendix C.

# Applications For Pass. Cars, Light Trucks, SUV's, & Vans

VEHICLE MAKE, MODEL & YEAR	<b>GR-2</b>	<b>Gas-a-Just</b>	<b>MonoMax</b> 56XXXX Series	STRUT & SHOCK	
MARQUE, MODELE ET	<b>Excel-G</b>		<b>AGX</b> 7XXXXX Series	MOUNTS	BOOT KITS
ANNEE DU VEHICULE					
LA MARCA EL MODELO & AÑO					

## CHEVROLET Silverado SS (AWD)

2003-06	ALL									
---------	-----	--	--	--	--	--	--	--	--	--

## CHEVROLET Spectrum (Also See GEO)

1985-88	ALL	Right Hand	232015								
		Left Hand	232016	KG4542	KG4542			SM5297	SM5297	SB102	SB102

## CHEVROLET Sprint

1987-88	ALL Incl. Turbo	Right Hand	232019	341075							
		Left Hand	232020	341075							
1985-86	ALL	Right Hand		342012							
		Left Hand		342012							

## CHEVROLET Sprint (Canadian Vehicle)

1989-91	ALL	Right Hand	232025	232027							
		Left Hand	232026	232027				SM5188	SM5189	SB103	SB101
								SM5188	SM5189	SB103	SB101

## CHEVROLET Storm (Canadian Vehicle)

1993	ALL	Right Hand	234041	232033							
		Left Hand	234042	232034				SM5081	SM5105	SB102	SB105
								SM5081	SM5105	SB102	SB105

## CHEVROLET Suburban 1/2 Ton (2WD) C & R Series













2010	1500 (Exc. Electronic or Premium Smooth Ride Susp.)										
								SM5530		SB129	
2007-09	1500 (Exc. Electronic or Premium Smooth Ride Susp.)		341493	345073	551121	555054			SM5530		SB129
2000-06	1500 (Exc. Electronic or Premium Smooth Ride Susp.)		344381	344384	KG54327	KG54341	565067	565103			
	1500 w/ ZW7 Premium Smooth Ride Susp. (Exc. Z55 Autoride Susp.)		341343	SR2004	KG5040						
1992-99	C1500		344265	344273	KG5478	KG54100	565060	565033			
1989-91	R1500		344068	344072	KG5409	KG5415	565032	565036			
1987-88	R10		344068	344072	KG5409	KG5415	565032	565036			
1973-86	C10		344068	344072	KG5409	KG5415	565032	565036			
1967-72	C10		344068		KG5409	KG5416	565032				
1963-66	C10		344068	344085	KG5409	KG5419	565032	565037			

## CHEVROLET Suburban 1/2 Ton (4WD) K & V Series

2010	1500 (Exc. Electronic or Premium Smooth Ride Susp.)										
									SM5530		SB129
2007-09	1500 (Exc. Electronic or Premium Smooth Ride Susp.)		341493	345073	551121	555054			SM5530		SB129
2000-06	1500 (Exc. Electronic or Premium Smooth Ride Susp.)		344381	344384	KG54327	KG54341	565067	565103			
	1500 w/ ZW7 Premium Smooth Ride Susp. (Exc. Z55 Autoride Susp.)		341343	SR2004	KG5040						
	1500 w/ Z-71 Off Road Package				KG54327	KG54341	565067	565103			
1992-99	K1500		344266	344262	KG5480	KG54101	565062	565034			
1980-91	ALL w/ Dual Front Shocks - outside shock		344067	344072	KG5408	KG5415	565031	565036			
1985-91	ALL w/ Dual Front Shocks - inside shock			344072	KG5477	KG5415	565039	565036			
1980-84	ALL w/ Dual Front Shocks - inside shock		344075	344072	KG5430	KG5415	565039	565036			

Notes de bas de Page 320 - Guia de notas al calce del catalogo Pg. 321  
 Bold part numbers indicate the most comparable KYB product to the original design & performance.  
 (22) For vehicles with Electronic Susp., Leveling Control, and Air Suspensions refer to Appendix C.

# Applications For Pass. Cars, Light Trucks, SUV's, & Vans

VEHICLE MAKE, MODEL & YEAR	  	STRUT & SHOCK		BOOT KITS	
MARQUE, MODELE ET		MOUNTS			
ANNEE DU VEHICULE					
LA MARCA EL MODELO & AÑO					
	 	 	 	 	 

## CHEVROLET Suburban 1/2 Ton (4WD) K & V Series (continued)

1989-91	V1500 (Exc. w/ Dual Front Shocks)	344067	344072	KG5408	KG5415	565031	565036				
1987-88	V10 (Exc. w/ Dual Front Shocks)	344067	344072	KG5408	KG5415	565031	565036				
1973-86	K10 (Exc. w/ Dual Front Shocks)	344067	344072	KG5408	KG5415	565031	565036				
1969-72	K10	344067		KG5408	KG5417	565031					

## CHEVROLET Suburban 3/4 Ton (2WD) C & R Series

2001-09	2500 w/ Torsion Bar Front Susp. (Exc. Z55 Autoride & QuadraSteer)	344383	344384	KG54340	KG54341	565102	565103				
2000-01	2500 w/ Coil Spring Front Susp. (Exc. Z55 Autoride)	344402	344384	KG54339	KG54341	565101	565103				
1992-99	C2500	344265	344273	KG5478	KG54100	565060	565033				
1989-91	R2500	344068	344072	KG5409	KG5415	565032	565036				
1987-88	R20	344068	344072	KG5409	KG5415	565032	565036				
1973-86	C20	344068	344072	KG5409	KG5415	565032	565036				
1967-72	C20	344068		KG5409	KG5416	565032					
1963-66	C20	344068	344085	KG5409	KG5419	565032	565037				

## CHEVROLET Suburban 3/4 Ton (4WD) K & V Series

2000-09	2500 (Exc. Z55 Autoride Susp. & QuadraSteer)	344383	344384	KG54340	KG54341	565102	565103				
1992-99	K2500	344266	344262	KG5480	KG54101	565062	565034				
1980-91	ALL w/ Dual Front Shocks - outside shock	344067	344072	KG5408	KG5415	565031	565036				
1985-91	ALL w/ Dual Front Shocks - inside shock		344072	KG5477	KG5415	565039	565036				
1980-84	ALL w/ Dual Front Shocks - inside shock	344075	344072	KG5430	KG5415	565039	565036				
1989-91	V2500 (Exc. w/ Dual Front Shocks)	344067	344072	KG5408	KG5415	565031	565036				
1987-88	V20 (Exc. w/ Dual Front Shocks)	344067	344072	KG5408	KG5415	565031	565036				
1973-86	K20 (Exc. w/ Dual Front Shocks)	344067	344072	KG5408	KG5415	565031	565036				
1969-72	K20	344067		KG5408	KG5417	565031					

## CHEVROLET Suburban (4WD) Steering Stabilizer

2000-05	Complete Unit	SS15326									
1993-98	w/ OE Unit (Cylinder only)	SS10317									
1973-92	OEM Replacement Cylinder	SS10325									

## CHEVROLET Suburban (4WD) - Lift Replacement Shocks

2000-06	1500 Suburban (Exc. Z55 Autoride Susp. or Premium Smooth Ride Susp.) Lift = 2.5-5"					565076					
1992-99	Suburban Lift = 1-3" for Edelbrock # 6360 Lift = 4-6" for Rancho # RS5244 Lift = 4-6" for Rancho # RS9244 Lift = 4-6" for Rancho # RSX17316 Lift = 4-6" for Edelbrock # 63003 Lift = 4-6" for Edelbrock # 6460 Lift = 4-6" for Rancho # RS5227 Lift = 4-6" for Rancho # RS9227 Lift = 4-6" for Rancho # RSX17315 Lift = 4-6"					565073 565086 565092 565092 565086	565061				
							565093 565087 565093 565093 565093				

Notes de bas de Page 320 - Guia de notas al calce del catalogo Pg. 321

Bold part numbers indicate the most comparable KYB product to the original design & performance.  
(22) For vehicles with Electronic Susp., Leveling Control, and Air Suspensions refer to Appendix C.

# Applications For Pass. Cars, Light Trucks, SUV's, & Vans

VEHICLE MAKE, MODEL & YEAR	<b>GR-2</b>		<b>Gas-a-Just</b>		<b>MonoMax</b> 56XXXX Series		STRUT & SHOCK			
MARQUE, MODELE ET	<b>Excel-G</b>				<b>AGX</b> 7XXXX Series		MOUNTS		BOOT KITS	
ANNEE DU VEHICULE										
LA MARCA EL MODELO & AÑO										

## CHEVROLET Tahoe (2WD)

2010	ALL (Exc. Electronic, ZW7 Premium Smooth Ride Susp. & Police Package)							SM5530		SB129	
2007-09	ALL (Exc. Electronic, ZW7 Premium Smooth Ride Susp. & Police Package)	341493	345073	551121	555054			SM5530		SB129	
2001-06	ALL (Exc. Z55 Autoride Susp. or Premium Smooth Ride Susp.)	344381	344384	KG54327	KG54341	565067	565103				
	ALL w/ ZW7 Premium Smooth Ride Susp. (Exc. Z55 Autoride Susp.)	341343	SR2003	KG5040							
2000	ALL 4 Door (New Style) (Exc. Z55 Autoride Susp. or Premium Smooth Ride Susp.)	344381	344384	KG54327	KG54341	565067	565103				
	ALL 4 Door (New Style) w/ Premium Smooth Ride Susp. (Exc. Z55 Autoride Susp.)	341343	SR2003	KG5040							
	ALL (Old Style)	344265	344273	KG5478	KG54100	565060	565033				
1995-99	4 Door	344265	344273	KG5478	KG54100	565060	565033				
	2 Door	344265	344263	KG5478	KG5479	565060	565061				
	2 Door (Lowered 2" / 4")					565060	565033				

## CHEVROLET Tahoe (4WD)

2010	ALL (Exc. Electronic, ZW7 Premium Smooth Ride Susp. & Police Package)							SM5530		SB129	
2007-09	ALL (Exc. Electronic, ZW7 Premium Smooth Ride Susp. & Police Package)	341493	345073	551121	555054			SM5530		SB129	
2001-06	ALL (Exc. Z55 Autoride Susp. or Premium Smooth Ride Susp.)	344381	344384	KG54327	KG54341	565067	565103				
	ALL w/ ZW7 Premium Smooth Ride Susp. (Exc. Z55 Autoride Susp.)	341343	SR2003	KG5040							
	ALL (w/ Z71 Off Road Package)			KG54327	KG54341	565067	565103				
2000	ALL 4 Door (New Style) (Exc. Z55 Autoride Susp. or Premium Smooth Ride Susp.)	344381	344384	KG54327	KG54341	565067	565103				
	ALL 4 Door (New Style) w/ Premium Smooth Ride Susp. (Exc. Z55 Autoride Susp.)	341343	SR2003	KG5040							
	ALL (Old Style)	344266	344263	KG5480	KG5479	565062	565061				
1995-99	ALL 2 Door	344266	344263	KG5480	KG5479	565062	565061				
	ALL 4 Door	344266	344262	KG5480	KG54101	565062	565034				

## CHEVROLET Tahoe (4WD) Steering Stabilizer

1995-05	Complete Unit	SS15326									
---------	---------------	---------	--	--	--	--	--	--	--	--	--













## CHEVROLET Tahoe (4WD) - Lift Replacement Shocks

2001-06	ALL (Exc. Z55 Autoride Susp. or Premium Smooth Ride Susp.) Lift = 2.5-5"					565076					
2000	ALL (New Style) (Exc. Z55 Autoride Susp. or Premium Smooth Ride Susp.) Lift = 2.5-5"					565076					
	ALL (Old Style) Lift = 1-3"					565073	565074				
1995-99	ALL 2 Door Lift = 1-3"					565073	565074				
	ALL 4 Door Lift = 1-3"					565073					
	for Edelbrock # 6360 Lift = 4-6"					565086					
	for Rancho # RS5244 Lift = 4-6"					565092					
	for Rancho # RS9244 Lift = 4-6"					565092					
	for Rancho # RSX17316 Lift = 4-6"					565086					
	for Edelbrock # 63003 Lift = 4-6"						565087				

Notes de bas de Page 320 - Guia de notas al calce del catalogo Pg. 321

Bold part numbers indicate the most comparable KYB product to the original design & performance.  
(22) For vehicles with Electronic Susp., Leveling Control, and Air Suspensions refer to Appendix C.

# Applications For Pass. Cars, Light Trucks, SUV's, & Vans

VEHICLE MAKE, MODEL & YEAR	  	STRUT & SHOCK		BOOT KITS	
MARQUE, MODELE ET		MOUNTS			
ANNEE DU VEHICULE					
LA MARCA EL MODELO & AÑO					
	 	 	 	 	 

## CHEVROLET Tahoe (4WD) - Lift Replacement Shocks (continued)

1995-99	for Edelbrock # 6460 Lift = 4-6" for Rancho # RS5227 Lift = 4-6" for Rancho # RS9227 Lift = 4-6" for Rancho # RSX17315 Lift = 4-6"						565087 565087 565087 565087				
---------	---	--	--	--	--	--	--------------------------------------	--	--	--	--

## CHEVROLET Townsman

1971-72	ALL	343127	343157								
1969-70	ALL	343128	343130								

## CHEVROLET Tracker (Also See GEO)

1999-04	ALL	Right Hand	334195	343247		KG4745A					
		Left Hand	334196	343247		KG4745A					
	Strut Mount (1.6L) Strut Mount (2.0 & 2.5L)							SM5367 SM5366			
1996-98	ALL w/ 4 Wheel ABS	Right Hand	334195	343247		KG4745A					
		Left Hand	334196	343247		KG4745A			SM5082 SM5082		
1989-98	ALL (Exc. ABS)	Right Hand	235035	343247		KG4745A					
		Left Hand	235036	343247		KG4745A			SM5082 SM5082		

## CHEVROLET Trailblazer

2008-09	ALL Mount w/ Spring Insulator Lower Spring Seat Insulator		343395			KG4162			SM5395 SM5548		
2002-07	ALL Mount w/ Spring Insulator Lower Spring Seat Insulator		331043 <sup>81</sup>	343395		KG4162			SM5395 SM5548		SB108

## CHEVROLET Traverse

2009-10	Strut Boot										SB101
---------	------------	--	--	--	--	--	--	--	--	--	-------

## CHEVROLET Two-Ten Series

1955-57	ALL	343127	343149								
---------	-----	--------	--------	--	--	--	--	--	--	--	--

## CHEVROLET Uplander (AWD)

2005-06	ALL Upper Spring Seat w/ Insulator Upper Spring Seat Insulator Lower Spring Seat Insulator		335061						SM5143 SM5470 SM5467 SM5437		SB127
---------	---	--	--------	--	--	--	--	--	--------------------------------------	--	-------

## CHEVROLET Uplander (FWD)

2005-08	ALL (Exc. Self Leveling Rear) Upper Spring Seat Insulator Upper Spring Seat w/ Insulator Lower Spring Seat Insulator		335061	344338		KG54325			SM5143 SM5467 SM5470 SM5437	SM5549 SM5549	SB127
---------	---	--	--------	--------	--	---------	--	--	--------------------------------------	------------------	-------

## CHEVROLET Vega

1975-77	ALL	343129	343132								
1972-74	ALL		343132								
1971	ALL		343131								

<sup>81</sup> Replaces [331016], when stock is depleted



# Applications For Pass. Cars, Light Trucks, SUV's, & Vans

VEHICLE MAKE, MODEL & YEAR	<b>GR-2</b>		<b>Gas-a-Just</b>		<b>MonoMax</b> 56XXXX Series		STRUT & SHOCK			
MARQUE, MODELE ET	<b>Excel-G</b>				<b>AGX</b> 7XXXX Series		MOUNTS		BOOT KITS	
ANNEE DU VEHICULE										
LA MARCA EL MODELO & AÑO										

## CHEVROLET Venture Mini-Van

1997-05	ALL w/ Rear Level Control ALL w/o Rear Level Control Upper Spring Seat w/ Insulator Upper Spring Seat Insulator Lower Spring Seat Insulator (FWD) Lower Spring Seat Insulator Upper Spring Seat Insulator (FWD)	334227 334227	344338		KG54325			SM5143 SM5143 SM5470 SM5467 SM5437	SM5549 SM5549	SB127 SB127	
---------	---	------------------	--------	--	---------	--	--	--	------------------	----------------	--

## CHRYSLER 300 (AWD)

2008-10	Strut Boot									SB101	
2005-09	ALL (Exc. Self Leveling Rear) ALL w/ Self Leveling Rear	341673 341673	349086						SM5533		
2005-07										SB101	

## CHRYSLER 300 (RWD)

2008-10	Strut Boot									SB101	
2005-09	ALL (Exc. Self Leveling Rear) Right Hand Left Hand ALL w/ SRT8 Option ALL w/o SRT8 Option Upper Spring Seat Insulator (w/o SRT8)	341608 341609	349065 349065					SM5535 SM5555	SM5534 SM5533		
2005-07	ALL w/ 5.7L ALL w/o 5.7L									SB101 SB103	
1970-71	ALL			KG4507							
1965-69	ALL		343159	KG4507	KG5512						

## CHRYSLER 300M (Exc. Performance Handling Package)

1998-04	ALL Right Hand Left Hand	235617 235618	235619 235619					SM5167 SM5167	SM5168 SM5168	SB101 SB101	SB107 SB107
---------	-----------------------------	------------------	------------------	--	--	--	--	------------------	------------------	----------------	----------------

## CHRYSLER Aspen (SUV)

2007-09	ALL (Exc. Hybrid)			KG4160	KG4159						
---------	-------------------	--	--	--------	--------	--	--	--	--	--	--

## CHRYSLER Cirrus

1995-00	ALL	344609	344610					SM5262	SM5137	SB108	SB107
---------	-----	--------	--------	--	--	--	--	--------	--------	-------	-------

## CHRYSLER Concorde











1998-04	ALL Right Hand Left Hand	235617 235618	235619 235619					SM5167 SM5167	SM5168 SM5168	SB101 SB101	SB101 SB101
1993-97	ALL Right Hand Left Hand Upper Spring Seat Lower Spring Seat Insulator	234601 234602	234603 234603					SM5110 SM5110 SM5231 SM5556	SM5111 SM5111	SB101 SB101	SB102 SB102

## CHRYSLER Conquest

9/86-89	ALL (Exc. Adj. Susp.) Right Hand Left Hand	365060 365060						SM5313 SM5313	SM5310 SM5310	SB102 SB102	SB101 SB101
1983-8/86	ALL (Exc. Adj. Susp.) Right Hand Left Hand	365029 365029						SM5313 SM5313	SM5310 SM5310	SB102 SB102	SB102 SB102

Notes de bas de Page 320 - Guia de notas al calce del catalogo Pg. 321  
 Bold part numbers indicate the most comparable KYB product to the original design & performance.  
 (22) For vehicles with Electronic Susp., Leveling Control, and Air Suspensions refer to Appendix C.

# Applications For Pass. Cars, Light Trucks, SUV's, & Vans

VEHICLE MAKE, MODEL & YEAR	<b>GR-2</b>	<b>Gas-a-Just</b>	<b>MonoMax</b> 56XXXX Series	STRUT & SHOCK	
MARQUE, MODELE ET	<b>Excel-G</b>		<b>AGX</b> 7XXXXX Series	MOUNTS	BOOT KITS
ANNEE DU VEHICULE	 	 	 	 	 
LA MARCA EL MODELO & AÑO					

## CHRYSLER Cordoba

1980-83	ALL	343138	343139	KG4528	KG5546					
1977-79	ALL	343158	343139		KG5546					
1975-76	ALL	343158	343159		KG5512					

## CHRYSLER Crossfire

2004-08	ALL	NA	NA							
---------	-----	----	----	--	--	--	--	--	--	--

## CHRYSLER Daytona (Canadian Vehicle)

1/86-93	ALL Upper Spring Seat Spacer Upper Spring Seat Lower Spring Seat Insulator	235902	343164		KG5563			SM5003 SM5219 SM5130 SM5131		SB104
84-12/85	ALL	234003	343164		KG5563			SM5004		SB104

## CHRYSLER Dynasty (Canadian Vehicle) (Footnote # 22)

1988-93	ALL w/ Air Leveling System ALL w/o Air Leveling System Upper Spring Seat Spacer Upper Spring Seat Lower Spring Seat Insulator	235902 235902	343164		KG5563 <sup>22</sup> KG5563			SM5003 SM5003 SM5219 SM5130 SM5131		SB103 SB103
---------	---	------------------	--------	--	--------------------------------	--	--	--	--	----------------

## CHRYSLER E Class

1984	ALL	234003	343164		KG5563			SM5004		SB104
1983	ALL	234001	343164		KG5563			SM5002		SB101

## CHRYSLER Executive Limousine

1/86	ALL Upper Spring Seat Spacer Upper Spring Seat Lower Spring Seat Insulator	235902	343164		KG5563			SM5003 SM5219 SM5130 SM5131		SB104
84-12/85	ALL	234003	343164		KG5563			SM5004		SB104
1983	ALL	234001	343164		KG5563			SM5002		SB101

## CHRYSLER Fifth Avenue (New Yorker) (Exc. Air Suspension)

1990-93	ALL w/ Air Level ALL w/o Air Level Upper Spring Seat Spacer Upper Spring Seat Lower Spring Seat Insulator	235902 235902	343164		KG5563 <sup>22</sup> KG5563			SM5003 SM5003 SM5219 SM5130 SM5131		SB103 SB103
1983-89	ALL	343138	343139	KG4528	KG5546					

## CHRYSLER Imperial

1990-93	ALL (Exc. Air Susp.) (Footnote #22) Upper Spring Seat Spacer Upper Spring Seat Lower Spring Seat Insulator	235902	343164		KG5563			SM5003 SM5219 SM5130 SM5131		SB103
1981-83	ALL	343138	343139	KG4528	KG5546					
1974-75	ALL	343138	343159	KG4528	KG5512					
1970-73	ALL			KG4507						
1967-69	ALL		343159	KG4507	KG5512					





<sup>22</sup> For vehicles with Electronic Susp., Leveling Control, and Air Suspensions refer to Appendix C.

Notes de bas de Page 320 - Guia de notas al calce del catalogo Pg. 321

Bold part numbers indicate the most comparable KYB product to the original design & performance.

(22) For vehicles with Electronic Susp., Leveling Control, and Air Suspensions refer to Appendix C.

# Applications For Pass. Cars, Light Trucks, SUV's, & Vans

VEHICLE MAKE, MODEL & YEAR		<b>GR-2</b>		<b>Gas-a-Just</b>		<b>MonoMax</b> 56XXXX Series		STRUT & SHOCK			
MARQUE, MODELE ET		<b>Excel-G</b>				<b>AGX</b> 7XXXX Series		MOUNTS		BOOT KITS	
ANNEE DU VEHICULE											
LA MARCA EL MODELO & AÑO											
											

## CHRYSLER Intrepid (Canadian Vehicle)

1999-02	R/T		NA	235619					SM5167	SM5168	SB101	
1998-04	ALL (Exc. R/T)	Right Hand	235617	235619					SM5167	SM5168	SB101	SB107
		Left Hand	235618	235619					SM5167	SM5168	SB101	SB107
1993-97	ALL	Right Hand	234601	234603					SM5110	SM5111	SB101	SB102
		Left Hand	234602	234603					SM5110	SM5111	SB101	SB102
	Upper Spring Seat								SM5231			
	Lower Spring Seat Insulator								SM5556	SM5557		

## CHRYSLER LHS (Exc. Performance Handling Package)

1999-01	ALL	Right Hand	235617	235619					SM5167	SM5168	SB101	SB107
		Left Hand	235618	235619					SM5167	SM5168	SB101	SB107
1994-97	ALL	Right Hand	234601	234603					SM5110	SM5111	SB101	SB102
		Left Hand	234602	234603					SM5110	SM5111	SB101	SB102
	Upper Spring Seat								SM5231			

## CHRYSLER Laser

1/86 - 86	ALL		235902	343164		KG5563			SM5003		SB104	
	Upper Spring Seat Spacer								SM5219			
	Upper Spring Seat								SM5130			
	Lower Spring Seat Insulator								SM5131			
84-12/85	ALL		234003	343164		KG5563			SM5004		SB104	

## CHRYSLER Le Baron

1/86-95	ALL		235902	343164		KG5563			SM5003		SB104	
	Upper Spring Seat Spacer								SM5219			
	Upper Spring Seat								SM5130			
	Lower Spring Seat Insulator								SM5131			
84-12/85	ALL		234003	343164		KG5563			SM5004		SB104	
1983	ALL		234001	343164		KG5563			SM5002		SB101	
1982	ALL		234001	343164		KG5563			SM5001		SB101	
1977-81	ALL		343138	343139	KG4528	KG5546						

## CHRYSLER Neon (Canadian Vehicle)

2000-05	ALL (Exc. Performance Package)											
		Right Hand	235627	235628					SM5265	SM5198	SB104	SB101
		Left Hand	235627	235629					SM5265	SM5198	SB104	SB101
	Mount & Spring Seat w/ Insulator								SM5199			
	Upper Spring Seat w/ Insulator								SM5344			
	Lower Spring Seat Insulator								SM5417	SM5464		

## CHRYSLER Newport

1979-81	ALL		343158	343139		KG5546						
1974-78	ALL		343138	343159	KG4528	KG5512						
1970-73	ALL				KG4507							
1965-69	ALL			343159	KG4507	KG5512						

## CHRYSLER New Yorker (Exc. Air Suspension) (Footnote # 22)

1994-97	ALL	Right Hand	234601	234603					SM5110	SM5111	SB101	SB101
		Left Hand	234602	234603					SM5110	SM5111	SB101	SB101
	Upper Spring Seat								SM5231			
	Lower Spring Seat Insulator								SM5556	SM5557		
1988-93	ALL (Exc. Turbo) (w/o Air Level)		235902	343164		KG5563			SM5003		SB103	
	ALL (Exc. Turbo) w/ Air Level		235902			KG5563 <sup>22</sup>			SM5003		SB103	













<sup>22</sup> For vehicles with Electronic Susp., Leveling Control, and Air Suspensions refer to Appendix C.

Notes de bas de Page 320 - Guia de notas al calce del catalogo Pg. 321

Bold part numbers indicate the most comparable KYB product to the original design & performance.

(22) For vehicles with Electronic Susp., Leveling Control, and Air Suspensions refer to Appendix C.

# Applications For Pass. Cars, Light Trucks, SUV's, & Vans

VEHICLE MAKE, MODEL & YEAR	  	STRUT & SHOCK		BOOT KITS	
MARQUE, MODELE ET		MOUNTS			
ANNEE DU VEHICULE					
LA MARCA EL MODELO & AÑO	 	 	 	 	 

## CHRYSLER New Yorker (Exc. Air Suspension) (Footnote # 22) (continued)

1988	ALL w/ Turbo	235902	343164		KG5563			SM5003		SB104	
1/86-93	Upper Spring Seat Upper Spring Seat Spacer Lower Spring Seat Insulator							SM5130 SM5219 SM5131			
1/86-87	ALL (Exc. Fifth Avenue)	235902	343164		KG5563			SM5003		SB104	
1984-12/85	ALL (Exc. Fifth Avenue)	234003	343164		KG5563			SM5004		SB104	
1983	ALL (Exc. Fifth Avenue)	234001	343164		KG5563			SM5002		SB101	
1982	ALL	343138	343139	KG4528	KG5546						
1979-81	ALL	343158	343139		KG5546						
1974-78	ALL	343138	343159	KG4528	KG5512						
1970-73	ALL			KG4507							
1965-69	ALL		343159	KG4507	KG5512						

## CHRYSLER PT Cruiser

2010	ALL	235626									
2001-09	ALL Mount & Spring Seat w/ Insulator Upper Spring Seat w/ Insulator Lower Spring Seat Insulator	235626	343385		553333			SM5265 SM5199 SM5344 SM5417		SB104	

## CHRYSLER Pacifica

2004-08	AWD FWD	339088 339088	SR2007 SR2006					SM5389 SM5389	SM5534 SM5534	SB126 SB126	
---------	------------	------------------	------------------	--	--	--	--	------------------	------------------	----------------	--

## CHRYSLER Prowler

2001-02	ALL	NA	NA								
---------	-----	----	----	--	--	--	--	--	--	--	--

## CHRYSLER Sebring

2008-10	FWD Sedan		341479								
2007-09	ALL									SB101	SB107
2007	FWD		341479								
2005	Coupe Upper Spring Seat Insulator	Right Hand Left Hand	235630 235631	341293 341293				SM5388 SM5388	SM5091 SM5091 SM5433	SB103 SB103	SB101 SB101
2004-06	Convertible Sedan Mount Plate w/ Insulator (Sedan) Mount Plate w/ Insulator (Convertible)		341604 341604	344610 344610				SM5264 SM5264	SM5263 SM5263 SM5512 SM5532	SB108 SB108	SB107 SB108
2003-04	Coupe w/ 3.0 Eng. w/o 3.0 Eng. Upper Spring Seat Insulator (Coupe)	Right Hand Left Hand	235630 235631	341293 341293				SM5388 SM5388	SM5091 SM5091 SM5433	SB103 SB103	SB107 SB103
2003	Sedan & Convertible Mount Plate w/ Insulator (Sedan) Mount Plate w/ Insulator (Convertible)		341604	344610				SM5264	SM5263 SM5512 SM5532	SB108	SB108
2001-02	Coupe Sedan & Convertible Mount Plate w/ Insulator (Sedan) Mount Plate w/ Insulator (Convertible) Upper Spring Seat Insulator (Coupe)	Right Hand Left Hand	235630 235631 344609	341293 341293 344610				SM5388 SM5388 SM5264	SM5091 SM5091 SM5238 SM5512 SM5532 SM5433	SB103 SB103 SB108	SB103 SB103 SB108
1997-00	Convertible		344609	344610				SM5262	SM5238	SB108	SB107

Notes de bas de Page 320 - Guia de notas al calce del catalogo Pg. 321

Bold part numbers indicate the most comparable KYB product to the original design & performance.  
(22) For vehicles with Electronic Susp., Leveling Control, and Air Suspensions refer to Appendix C.

# Applications For Pass. Cars, Light Trucks, SUV's, & Vans

VEHICLE MAKE, MODEL & YEAR										
MARQUE, MODELE ET	<b>GR-2</b>	<b>Gas-a-Just</b>	<b>MonoMax</b> 56XXXX Series	STRUT & SHOCK						
ANNEE DU VEHICULE	<b>Excel-G</b>		<b>AGX</b> 7XXXXX Series	MOUNTS						BOOT KITS
LA MARCA EL MODELO & AÑO										

## CHRYSLER Sebring (continued)

1996	Convertible	344609	344610					SM5262	SM5137	SB108	SB107
1995-00	Coupe Upper Spring Seat Insulator	341141	341165			741018	741019	SM5091	SM5091 SM5433	SB101	SB101

## CHRYSLER TC (Maserati)

1989-91	ALL Upper Spring Seat Spacer Upper Spring Seat Lower Spring Seat Insulator	235902	343164		KG5563			SM5003 SM5219 SM5130 SM5131		SB104	
---------	---	--------	--------	--	--------	--	--	--------------------------------------	--	-------	--

## CHRYSLER Town & Country (Pre-1990)

1/86-88	ALL Upper Spring Seat Spacer Upper Spring Seat Lower Spring Seat Insulator	235902	343164		KG5563			SM5003 SM5219 SM5130 SM5131		SB104	
84-12/85	ALL	234003	343164		KG5563			SM5004		SB104	
1983	ALL	234001	343164					SM5002		SB101	
1982	ALL	343138	343139	KG4528	KG5546						
1979-81	ALL	343158	343139		KG5546						
1974-78	ALL	343138	343159	KG4528	KG5512						
1971-73	ALL			KG4507							
1965-70	ALL		343159	KG4507	KG5512						

## CHRYSLER Town & Country Mini Van (also see STRUT-PLUS)

2010	ALL (Exc. Self Leveling Rear)	334673									
2008-10	Strut / Shock Boot									SB101	
2008-09	ALL (Exc. Rear Self Leveling)	334673	349073								
2001-07	ALL (Exc. AWD Model) (Exc. Nivomat Rear Susp.)	334335	344080		KG5457			SM5266		SB126	
	ALL w/ AWD Upper Spring Seat Insulator Upper Spring Seat Lower Spring Seat Insulator	334335	SR2005					SM5266 SM5432 SM5552 SM5434		SB126	
2001-06	ALL w/ Nivomat Rear Susp. (Exc. AWD)	334335	SR2002					SM5266		SB126	
1996-00	ALL (Exc. Nivomat Load Leveling Rear Susp.)	334188	344080		KG5457			SM5112		SB126	
	ALL w/ Nivomat Rear Susp. Upper Spring Seat Lower Spring Seat Insulator	334188	SR2001					SM5112 SM5157 SM5410		SB126	
1990-95	ALL (Incl. AWD) Upper Spring Seat Spacer Upper Spring Seat Lower Spring Seat Insulator	235901	344080		KG5457			SM5003 SM5219 SM5130 SM5131		SB126	

## CHRYSLER Town & Country Mini Van - STRUT-PLUS











2006-07	ALL (Exc. Limited & Nivomat Load Leveling Rear Susp.) Right Hand Left Hand ALL w/ Nivomat Rear Susp. (Exc. Limited) Right Hand Left Hand	SR4038 SR4039 SR4038 SR4039									
---------	---	--------------------------------------	--	--	--	--	--	--	--	--	--

Notes de bas de Page 320 - Guia de notas al calce del catalogo Pg. 321

Bold part numbers indicate the most comparable KYB product to the original design & performance.

(22) For vehicles with Electronic Susp., Leveling Control, and Air Suspensions refer to Appendix C.

# Applications For Pass. Cars, Light Trucks, SUV's, & Vans

VEHICLE MAKE, MODEL & YEAR	<b>GR-2</b>	<b>Gas-a-Just</b>	<b>MonoMax</b> 56XXXX Series	STRUT & SHOCK			
MARQUE, MODELE ET	<b>Excel-G</b>		<b>AGX</b> 7XXXX Series	MOUNTS		BOOT KITS	
ANNEE DU VEHICULE	 	 	 	 	 		
LA MARCA EL MODELO & AÑO							

## CHRYSLER Town & Country Mini Van - STRUT-PLUS (continued)

2001-05	ALL (Exc. Nivomat Load Leveling Rear Susp.) Right Hand Left Hand	SR4038 SR4039									
	ALL w/ Nivomat Rear Susp. (Exc. AWD) Right Hand Left Hand	SR4038 SR4039									
1996-00	ALL (Exc. Nivomat Load Leveling Rear Susp.) Right Hand Left Hand	SR4020 SR4021									
	ALL w/ Nivomat Rear Susp. (Exc. AWD) Right Hand Left Hand	SR4020 SR4021									
1990-95	ALL (Incl. AWD)	SR4019									

## CHRYSLER Voyager & Grand Voyager Mini Van (also see STRUT-PLUS)

2001-03	ALL Upper Spring Seat Insulator Upper Spring Seat Lower Spring Seat Insulator	334335	344080		KG5457				SM5266 SM5432 SM5552 SM5434		SB126
2000	ALL Upper Spring Seat Lower Spring Seat Insulator	334188	344080		KG5457				SM5112 SM5157 SM5410		SB126

## CHRYSLER Voyager & Grand Voyager Mini Van - STRUT-PLUS

2001-03	ALL V6 Eng. Right Hand Left Hand	SR4038 SR4039									
2000	ALL V6 Eng. Right Hand Left Hand	SR4020 SR4021									

## DAEWOO Lanos

1999-02	ALL	365025	343177		KG4536						SB101
---------	-----	--------	--------	--	--------	--	--	--	--	--	-------

## DAEWOO Nubira

1999-02	Wagon (w/o ABS Brakes) Right Hand Left Hand	334207 334208									
1999-01	ALL w/ ABS Right Hand Left Hand	334209 334210	333254 333255								

## DAIHATSU Rocky

1990-92	ALL	344098	343219	KG5476	KG5517						
---------	-----	--------	--------	--------	--------	--	--	--	--	--	--

## DATSUN See Nissan

		----	----								
--	--	------	------	--	--	--	--	--	--	--	--

## DODGE 2000 GTX (Canadian Vehicle)

1989-90	ALL (Exc. 4WD) ALL w/ 4WD	235032 235032	341114 341121			734005 734005	741013 741014		SM5091 SM5091	SB101 SB101	SB107 SB107
---------	------------------------------	------------------	------------------	--	--	------------------	------------------	--	------------------	----------------	----------------

## DODGE 330

1963-64	ALL		343159	KG4510	KG5512						
---------	-----	--	--------	--------	--------	--	--	--	--	--	--

Notes de bas de Page 320 - Guia de notas al calce del catalogo Pg. 321  
 Bold part numbers indicate the most comparable KYB product to the original design & performance.  
 (2) For vehicles with Electronic Susp., Leveling Control, and Air Suspensions refer to Appendix C.

PASSENGER CARS / VOITURES / AUTOMOVILES  
LIGHT TRUCKS / CAMIONNETTE / CAMIONES LIGEROS

HEAVY DUTY / MOTORHOME / SERVICE INTENSIF / AUTOCARS ET  
AUTOCARAVANES / EQUIPOS PESADOS, AUTOBUSES, Y CASAS RODANTES

# Applications For Pass. Cars, Light Trucks, SUV's, & Vans

VEHICLE MAKE, MODEL & YEAR	<b>GR-2</b>		<b>Gas-a-Just</b>		<b>MonoMax</b> 56XXXX Series		STRUT & SHOCK			
MARQUE, MODELE ET	<b>Excel-G</b>				<b>AGX</b>		MOUNTS		BOOT KITS	
ANNEE DU VEHICULE					7XXXXX Series					
LA MARCA EL MODELO & AÑO										



## DODGE 400

1983	ALL	234001	343164		KG5563			SM5002		SB101	
1982	ALL	234001	343164		KG5563			SM5001		SB101	

## DODGE 440

1963-64	ALL		343159	KG4510	KG5512						
---------	-----	--	--------	--------	--------	--	--	--	--	--	--

## DODGE 600

1/86-88	ALL Upper Spring Seat Spacer Upper Spring Seat Lower Spring Seat Insulator	235902	343164		KG5563			SM5003 SM5219 SM5130 SM5131		SB104	
84-12/85	ALL	234003	343164		KG5563			SM5004		SB104	
1983	ALL	234001	343164		KG5563			SM5002		SB101	

## DODGE Aries

1/86-89	ALL Upper Spring Seat Spacer Upper Spring Seat Lower Spring Seat Insulator	235902	343164		KG5563			SM5003 SM5219 SM5130 SM5131		SB104	
84-12/85	ALL	234003	343164		KG5563			SM5004		SB104	
1983	ALL	234001	343164		KG5563			SM5002		SB101	
1981-82	ALL	234001	343164		KG5563			SM5001		SB101	

## DODGE Aspen (Car)

1976-80	ALL	343138	343139	KG4528	KG5546						
---------	-----	--------	--------	--------	--------	--	--	--	--	--	--

## DODGE Avenger

2008-10	FWD		341479								
2008-09	Strut / Shock Boot									SB101	SB107
1995-00	ALL Upper Spring Seat Insulator	341141	341165			741018	741019	SM5091 SM5091 SM5433		SB101	SB101

## DODGE Caliber













2010	ALL (Exc. SRT-4)		341654								
2007-09	ALL (Exc. SRT-4) Right Hand Left Hand Strut / Shock Boot	334642 334643	341654 341654							SB101	SB107

## DODGE Caravan, Grand Caravan Mini Van (also see STRUT-PLUS)

2010	ALL (Exc. Rear Self Leveling)	334673									
2008-10	Strut / Shock Boot									SB101	
2008-09	ALL (Exc. Rear Self Leveling)	334673	349073								
2001-07	ALL (Exc. AWD Model) (Exc. Nivomat Rear Susp.) ALL w/ AWD Upper Spring Seat Insulator Upper Spring Seat Lower Spring Seat Insulator	334335 334335	344080 SR2005		KG5457			SM5266 SM5266 SM5432 SM5552 SM5434		SB126 SB126	
2001-06	ALL w/ Nivomat Rear Susp. (Exc. AWD) Upper Spring Seat Insulator Lower Spring Seat Insulator	334335	SR2002					SM5266 SM5432 SM5434		SB126	

Notes de bas de Page 320 - Guia de notas al calce del catalogo Pg. 321  
 Bold part numbers indicate the most comparable KYB product to the original design & performance.  
 (22) For vehicles with Electronic Susp., Leveling Control, and Air Suspensions refer to Appendix C.

# Applications For Pass. Cars, Light Trucks, SUV's, & Vans

VEHICLE MAKE, MODEL & YEAR	  	STRUT & SHOCK		BOOT KITS	
MARQUE, MODELE ET		MOUNTS			
ANNEE DU VEHICULE					
LA MARCA EL MODELO & AÑO					
	 	 	 	 	 

## DODGE Caravan, Grand Caravan Mini Van (also see STRUT-PLUS) (continued)

1996-00	ALL (Exc. AWD Models w/ Self Leveling)	334188	344080		KG5457			SM5112		SB103
	ALL w/ Nivomat Rear Susp. Upper Spring Seat Lower Spring Seat Insulator	334188	SR2001					SM5112 SM5157 SM5410		SB103
1986-95	ALL (Incl. AWD) Upper Spring Seat Spacer Upper Spring Seat Lower Spring Seat Insulator	235901	344080		KG5457			SM5003 SM5219 SM5130 SM5131		SB126
1984-85	ALL	234004	344080		KG5457			SM5004		SB103

## DODGE Caravan, Grand Caravan Mini Van - STRUT-PLUS

2001-07	ALL V6 Eng. (Exc. Nivomat Load Leveling Rear Susp.) Right Hand Left Hand	SR4038 SR4039								
	ALL V6 Eng. w/ Nivomat Rear Susp. (Exc. AWD) Right Hand Left Hand	SR4038 SR4039								
1996-00	ALL V6 Eng. (Exc. Nivomat Load Leveling Rear Susp.) Right Hand Left Hand	SR4020 SR4021								
	ALL V6 Eng. w/ Nivomat Rear Susp. (Exc. AWD) Right Hand Left Hand	SR4020 SR4021								
1987-95	ALL V6 Eng. (Incl. AWD)	SR4019								

## DODGE Challenger

2009-10	ALL w/ SRT8 Option ALL w/o SRT8 Option Upper Spring Seat Insulator (w/o SRT8)							SM5535 SM5555	SM5533	SB101 SB103
2008-10	ALL w/ SRT8 Option								SM5534	
2008	Strut / Shock Boot									SB103
1981-83	ALL	365029						SM5312		
1970-74	ALL			KG4510	KG5512					

## DODGE Charger (AWD)

2008-10	Strut Boot									SB101
2007-09	ALL (Exc. Self Leveling Rear) ALL w/ Self Leveling Rear	341673 341673	349086						SM5533	
2007										SB101

## DODGE Charger (FWD)

1983-87	ALL	234001						SM5001	SM5018	SB101
---------	-----	--------	--	--	--	--	--	--------	--------	-------

## DODGE Charger (RWD)

2008-10	Strut Boot									SB101
2006-09	ALL (Exc. Self Leveling Rear) Right Hand Left Hand	341608 341609	349065 349065					SM5535 SM5555	SM5534 SM5533	
	ALL w/ SRT8 Option ALL w/o SRT8 Option Upper Spring Seat Insulator (w/o SRT8)									
2006-07	ALL w/ 5.7L									SB101

Notes de bas de Page 320 - Guia de notas al calce del catalogo Pg. 321  
 Bold part numbers indicate the most comparable KYB product to the original design & performance.  
 (22) For vehicles with Electronic Susp., Leveling Control, and Air Suspensions refer to Appendix C.



# Applications For Pass. Cars, Light Trucks, SUV's, & Vans

VEHICLE MAKE, MODEL & YEAR	<b>GR-2</b>	<b>Gas-a-Just</b>	<b>MonoMax</b> 56XXXX Series	STRUT & SHOCK	
MARQUE, MODELE ET	<b>Excel-G</b>		<b>AGX</b> 7XXXXX Series	MOUNTS	BOOT KITS
ANNEE DU VEHICULE					
LA MARCA EL MODELO & AÑO					

## DODGE Charger (RWD) (continued)

2006-07	ALL w/o 5.7L									SB103	
1977-78	ALL	343158	343139		KG5546						
1973-76	ALL	343158	343159		KG5512						
1966-72	ALL		343159	KG4510	KG5512						

## DODGE Colt (Canadian Vehicle)

1989-92	Colt 100E Sedan & Hatchback Colt 200E	233025 235033	342014 341084		KG3200A				SM5063	SM5091	SB101 SB104	SB107
---------	--	------------------	------------------	--	---------	--	--	--	--------	--------	----------------	-------

## DODGE Colt (Exc. Colt Vista)

1993-96	ALL (Exc. CA2A Model)	Right Hand Left Hand	234061 234062	341140 341140					SM5109 SM5109	SM5091 SM5091	SB101 SB101	SB107 SB107
1989-92	Hatchback		235033	341084					SM5063	SM5091	SB101	SB107
1987-90	Station Wagon w/ Power Steering Mount Insulator & Bearing		233025						SM5061 SM5317		SB104	
	Station Wagon w/o Power Steering Mount Insulator & Bearing		233025						SM5062 SM5318		SB104	
1987-88	ALL w/ Power Steering (Exc. Station Wagon)		233025	342014		KG3200A			SM5061		SB104	
	Mount Insulator & Bearing		233025	342014		KG3200A			SM5317 SM5062		SB104	
	ALL w/o Power Steering (Exc. Station Wagon)								SM5318			
	Mount Insulator & Bearing											
1985-86	ALL		233013	342014		KG3200A			SM5316		SB104	
1984	ALL (Exc. Sealed Struts)		365027			KG4192			SM5032		SB103	
1982-83	ALL		365027						SM5032		SB103	
1979-81	Hatchback		365027			KG4192			SM5032		SB103	
1977-80	Station Wagon			343030		KG4006			SM5315		SB103	

## DODGE Colt Vista

1986-91	4WD Station Wagon		235050			KG4192			SM5095		SB103	
1984-91	FWD Station Wagon		235006			KG4192			SM5095		SB103	

## DODGE Conquest

9/86-89	ALL (Exc. Adj. Susp.)	Right Hand Left Hand	365060 365060						SM5313 SM5313	SM5310 SM5310	SB102 SB102	SB101 SB101
1983-8/86	ALL (Exc. Adj. Susp.)	Right Hand Left Hand	365029 365029						SM5313 SM5313	SM5310 SM5310	SB102 SB102	SB102 SB102

## DODGE Coronet













1973-76	ALL		343158	343159		KG5512						
1965-72	ALL			343159	KG4510	KG5512						

## DODGE D50 Pickup

1982-93	2WD 4WD		344047 344047	344044 344045	KG5433 KG5433	KG5445 KG5438						
1979-81	ALL		344047	344044	KG5433	KG5434						

Notes de bas de Page 320 - Guia de notas al calce del catalogo Pg. 321  
 Bold part numbers indicate the most comparable KYB product to the original design & performance.  
 (22) For vehicles with Electronic Susp., Leveling Control, and Air Suspensions refer to Appendix C.

# Applications For Pass. Cars, Light Trucks, SUV's, & Vans

VEHICLE MAKE, MODEL & YEAR	  	STRUT & SHOCK		BOOT KITS	
MARQUE, MODELE ET		MOUNTS			
ANNEE DU VEHICULE					
LA MARCA EL MODELO & AÑO					
	 	 	 	 	 

## DODGE D100, D150 (1/2 Ton) (2WD) Pickup

1979-93	ALL	344066	344086	KG5403	KG5423					
1972-78	ALL	344066	344070	KG5403	KG5413					

## DODGE D200, D250 (3/4 Ton) (2WD) Pickup

1988-93	D200, D250 Diesel		344086	KG5404	KG5423					
1979-93	Gas (Exc. 165" WB & HD Package) Gas w/ 165" WB & HD Package	344066	344086 344086	KG5403 KG5404	KG5423 KG5423					
1972-78	ALL (Exc. 165" WB & HD Package) ALL w/ 165" WB & HD Package	344066	344070 344070	KG5403 KG5404	KG5413 KG5413					

## DODGE D300, D400 (1 Ton) (2WD) Pickup

1979-93	ALL		344086	KG5404	KG5423					
1972-78	ALL		344070	KG5404	KG5413					

## DODGE Dakota

2010	Strut / Shock Boot									SB103
2008-09	ALL Upper Spring Seat	340019	344378		KG54321	565040	SM5510 SM5546			SB103
2005-07	ALL Commercial or Performance Use Upper Spring Seat	341484 340019	344378		KG54321 KG54321	565040 565040	SM5510 SM5510 SM5546			SB103 SB103
1997-04	2WD 4WD	344081 344049	344378 344379	KG5458 KG5440	KG54321 KG54322	565049 565043	565040 565041			
1987-96	2WD 4WD	344094 344093	344096 344095	KG5470 KG5469	KG5472 KG5471					

## DODGE Dakota - Lift Replacement Shocks

1997-04	4WD Lift = 2-3"					565078	565079			
---------	-----------------	--	--	--	--	--------	--------	--	--	--

## DODGE Dart

1963-76	ALL			KG4509	KG5511					
1962	ALL			KG4509						

## DODGE Daytona

1/86-93	ALL Upper Spring Seat Spacer Upper Spring Seat Lower Spring Seat Insulator	235902	343164		KG5563			SM5003 SM5219 SM5130 SM5131		SB104
84-12/85	ALL	234003	343164		KG5563			SM5004		SB104

## DODGE Diplomat

1977-89	ALL (Incl. Police Pkg.)	343138	343139	KG4528	KG5546					
---------	-------------------------	--------	--------	--------	--------	--	--	--	--	--

## DODGE Durango

2004-09	ALL (Exc. Hybrid)			KG4160	KG4159					
1998-03	2WD 4WD	344081 344049	344378 344379	KG5458 KG5440	KG54321 KG54322	565049 565043	565040 565041			

Notes de bas de Page 320 - Guia de notas al calce del catalogo Pg. 321

Bold part numbers indicate the most comparable KYB product to the original design & performance.  
(2) For vehicles with Electronic Susp., Leveling Control, and Air Suspensions refer to Appendix C.

# Applications For Pass. Cars, Light Trucks, SUV's, & Vans

VEHICLE MAKE, MODEL & YEAR	<b>GR-2</b>	<b>Gas-a-Just</b>	<b>MonoMax</b> 56XXXX Series	STRUT & SHOCK	
MARQUE, MODELE ET	<b>Excel-G</b>		<b>AGX</b> 7XXXXX Series	MOUNTS	BOOT KITS
ANNEE DU VEHICULE					
LA MARCA EL MODELO & AÑO					

## DODGE Durango - Lift Replacement Shocks

1998-03	4WD Lift = 2-3"					565078	565079				
---------	-----------------	--	--	--	--	--------	--------	--	--	--	--

## DODGE Dynasty

1988-93	ALL w/ Air Leveling System ALL w/o Air Leveling System Upper Spring Seat Spacer Upper Spring Seat Lower Spring Seat Insulator	235902 235902	343164							SM5003 SM5003 SM5219 SM5130 SM5131	SB103 SB103
---------	---	------------------	--------	--	--	--	--	--	--	--	----------------

## DODGE Expo (Canadian Vehicle)

1987-89	ALL	234001	341037 <sup>2</sup>							SM5001	SM5018	SB101
---------	-----	--------	---------------------	--	--	--	--	--	--	--------	--------	-------

## DODGE Intrepid (Exc. Performance Handling Package)

1998-04	ALL	235617	235619							SM5167	SM5168	SB101	SB107
	Right Hand Left Hand	235618	235619							SM5167	SM5168	SB101	SB107
1993-97	ALL	234601	234603							SM5110	SM5111	SB101	SB102
	Right Hand Left Hand	234602	234603							SM5110	SM5111	SB101	SB102
	Upper Spring Seat Lower Spring Seat Insulator									SM5231 SM5556	SM5111 SM5557		

## DODGE Journey

2009-10	FWD (Exc. Self Leveling Rear Susp.)		341499									
---------	-------------------------------------	--	--------	--	--	--	--	--	--	--	--	--

## DODGE Lancer

1/86-89	ALL Upper Spring Seat Spacer Upper Spring Seat Lower Spring Seat Insulator	235902	343164							SM5003 SM5219 SM5130 SM5131	SB104
84-12/85	ALL	234003	343164							SM5004	SB104

## DODGE Magnum (AWD)

2008	Strut Boot											SB101
2005-08	ALL (Exc. Self Leveling Rear) ALL w/ Self Leveling Rear	341673 341673	349086								SM5533	SB101

## DODGE Magnum (RWD)

2008	Strut Boot											SB101
2005-08	RWD (Exc. Self-Leveling Susp.)	341608	349065									
	Right Hand Left Hand	341609	349065							SM5535 SM5555	SM5534 SM5533	
	ALL w/ SRT8 Option ALL w/o SRT8 Option Upper Spring Seat Insulator (w/o SRT8)									SM5555		
2005-07	ALL w/ 5.7L ALL w/o 5.7L											SB101 SB103
1978-79	ALL	343158	343139									

## DODGE Mirada













1979-83	ALL	343138	343139	KG4528	KG5546							
---------	-----	--------	--------	--------	--------	--	--	--	--	--	--	--

<sup>2</sup> The KYB replacement unit comes with a new dustcover/ bumper assembly.

Notes de bas de Page 320 - Guia de notas al calce del catalogo Pg. 321

Bold part numbers indicate the most comparable KYB product to the original design & performance.  
(22) For vehicles with Electronic Susp., Leveling Control, and Air Suspensions refer to Appendix C.

# Applications For Pass. Cars, Light Trucks, SUV's, & Vans

VEHICLE MAKE, MODEL & YEAR	  	STRUT & SHOCK		BOOT KITS	
MARQUE, MODELE ET		MOUNTS			
ANNEE DU VEHICULE					
LA MARCA EL MODELO & AÑO					
	 	 	 	 	 

## DODGE Monaco

1990-92	ALL		343220					SM5330		SB101	
1977-78	ALL (Exc. Police Package) ALL w/ Police Package	343158 343158	343139 343159		KG5546 KG5512						
1974-76	ALL	343138	343159	KG4528	KG5512						
1973	Station Wagon Sedan, Hardtop & Convertible		343159	KG4507 KG4507	KG5512						
1972	ALL		343159	KG4507	KG5512						
1971	ALL			KG4507							
1965-70	ALL		343159	KG4507	KG5512						

## DODGE Neon

2004-05	R/T & SRT	Right Hand Left Hand	NA NA	NA NA				SM5265 SM5265	SM5198 SM5198	SB104 SB104	SB101 SB101
2000-05	ALL (Exc. R/T & SRT) Mount & Spring Seat w/ Insulator Upper Spring Seat w/ Insulator Lower Spring Seat Insulator	Right Hand Left Hand	235627 235627	235628 235629				SM5265 SM5265 SM5199 SM5344 SM5417	SM5198 SM5198	SB104 SB104	SB101 SB101
1995-99	ALL (Exc. Competition Model) Upper Spring Seat Lower Spring Seat Insulator		234902	234901				SM5136 SM5158	SM5135 SM5464	SB101	SB104

## DODGE Nitro

2007-10	Upper Spring Seat Insulator Lower Spring Seat Insulator							SM5421 SM5421			
2007-08	ALL		331017	344404		KG5039					

## DODGE Omni

1990	ALL		341037 <sup>2</sup>					SM5001	SM5018	SB103	
1985-87	GLH, Shelby GLHS (4DR)		234001					SM5001	SM5018	SB101	
1981-89	ALL 4 Door (Exc. GLH)		234001	341037 <sup>2</sup>				SM5001	SM5018	SB101	
1981-87	ALL 2 Door		234001	341036 <sup>2</sup>				SM5001	SM5018	SB101	
1978-80	ALL 2 Door ALL 4 Door		234001 234001	341035 <sup>2</sup>				SM5001 SM5001	SM5018 SM5018	SB101 SB101	

## DODGE Polara

1973	Station Wagon Sedan, Hardtop & Convertible		343159	KG4507 KG4507	KG5512						
1972	ALL		343159	KG4507	KG5512						
1971	ALL			KG4507							
1965-70	ALL		343159	KG4507	KG5512						
1962-64	ALL		343159	KG4510	KG5512						

## DODGE RD200

1978-80	ALL		344074	344086	KG5422	KG5423					
---------	-----	--	--------	--------	--------	--------	--	--	--	--	--

## DODGE Raider

1989	w/ V6 Engine			KG5603A	KG5491						
1987-89	ALL (Exc. V6 Engine)		344045	KG5603A	KG4034						

<sup>2</sup> The KYB replacement unit comes with a new dustcover/ bumper assembly.

Notes de bas de Page 320 - Guia de notas al calce del catalogo Pg. 321  
 Bold part numbers indicate the most comparable KYB product to the original design & performance.  
 (22) For vehicles with Electronic Susp., Leveling Control, and Air Suspensions refer to Appendix C.

# Applications For Pass. Cars, Light Trucks, SUV's, & Vans

VEHICLE MAKE, MODEL & YEAR	<b>GR-2</b>	<b>Gas-a-Just</b>	<b>MonoMax</b> 56XXXX Series	STRUT & SHOCK	
MARQUE, MODELE ET	<b>Excel-G</b>		<b>AGX</b> 7XXXXX Series	MOUNTS	BOOT KITS
ANNEE DU VEHICULE					
LA MARCA EL MODELO & AÑO					

## DODGE Raider (4WD) - Steering Stabilizer

1987-88	Complete Kit	SS15345							
---------	--------------	---------	--	--	--	--	--	--	--

## DODGE Ram 1500 Pickup (2WD)

2009-10	ALL		344385		KG54342		565104		
2006-08	Mega Cab	344400	344401	KG5786	KG5196				
2002-08	ALL (Exc. Mega Cab & SRT-10)	344398	344385	KG5785	KG54342		565104		
1994-01	ALL	344372	344365	KG54102	KG54104	565015	565016		

## DODGE Ram 1500 Pickup (4WD)

2009-10	ALL		344385		KG54342		565104		
2006-08	ALL (Exc. Mega Cab) Commercial or Performance Use (Exc. Mega Cab) Upper Spring Seat	341485 341489	344385		KG54342 KG54342		565104 565104	SM5531 SM5531	SM5546
2002-05	ALL	344399	344385	KG5784	KG54342		565104		
1994-01	ALL	344376	344365	KG54315	KG54104	565017	565016		

## DODGE Ram 1500 Pickup (4WD) - Steering Stabilizer

1994-02	RAM 1500 Pickup (Cylinder Only)	SS10323							
---------	---------------------------------	---------	--	--	--	--	--	--	--

## DODGE Ram 1500, 2500, 3500 Pickup (4WD) - Lift Replacement Shocks

1994-02	2500 Series (Exc. 8800 GVW) Lift = 0-1" 2500 Series w/ 8800 GVW Lift = 0-1" 3500 Series (Exc. Chassis Cab) Lift = 0-1"					565017	565016		
						565018	565019		
						565018	565019		
1994-01	1500 Series Lift = 0-1"					565017	565016		

## DODGE Ram 2500 Pickup (2WD)

2003-09	ALL	344400	344401	KG5786	KG5196		565105		
1994-02	ALL	344372	344365	KG54102	KG54104	565015	565016		

## DODGE Ram 2500 Pickup (4WD)

2003-09	ALL (Exc. Power Wagon Model)	344364	344401	KG54103	KG5196	565018	565105		
1994-02	ALL (Exc. 8800 GVW) ALL w/ 8800 GVW	344376 344364	344365 344373	KG54315 KG54103	KG54104 KG54306	565017 565018	565016 565019		

## DODGE Ram 2500 Pickup (4WD) - Steering Stabilizer

1994-09	RAM 2500 Pickup (Cylinder Only)	SS10323							
---------	---------------------------------	---------	--	--	--	--	--	--	--

## DODGE Ram 3500 Pickup (2WD)

2003-09	ALL (Exc. Chassis Cab)	344400	345062	KG5786	554360				
1994-02	ALL (Exc. Chassis Cab) ALL Chassis Cab w/ Ind. Front Susp. ALL Chassis Cab w/ Solid Front Axle.	344372 344372 344364	344365 344373 344373	KG54102 KG54102 KG54103	KG54104 KG54306 KG54306	565015 565015 565018	565016 565019 565019		

## DODGE Ram 3500 Pickup (2WD) - Steering Stabilizer

1997-01	3500 w/ OEM #52029280 Replacement Cylinder Only	SS10333							
1994-97	3500 w/ OEM #52038276 Replacement Cylinder Only	SS10323							

Notes de bas de Page 320 - Guia de notas al calce del catalogo Pg. 321  
 Bold part numbers indicate the most comparable KYB product to the original design & performance.  
 (22) For vehicles with Electronic Susp., Leveling Control, and Air Suspensions refer to Appendix C.

# Applications For Pass. Cars, Light Trucks, SUV's, & Vans

VEHICLE MAKE, MODEL & YEAR	<b>GR-2</b>		<b>Gas-a-Just</b>		<b>MonoMax</b> 56XXXX Series		STRUT & SHOCK			
MARQUE, MODELE ET	<b>Excel-G</b>				<b>AGX</b>		MOUNTS		BOOT KITS	
ANNEE DU VEHICULE					7XXXXX Series					
LA MARCA EL MODELO & AÑO										

## DODGE Ram 3500 Pickup (4WD)

2007-09	ALL (Exc. Chassis Cab)	344364	344401	KG54103	KG5196	565018	565105				
2003-06	ALL	344364	344401	KG54103	KG5196	565018	565105				
1994-02	ALL	344364	344373	KG54103	KG54306	565018	565019				

## DODGE Ram 3500 Pickup (4WD) - Steering Stabilizer

1997-09	RAM 3500 Pickup (Cylinder Only)	SS10323									
---------	---------------------------------	---------	--	--	--	--	--	--	--	--	--

## DODGE RamVan Mini-Van (also see STRUT-PLUS)

1986-88	ALL Upper Spring Seat Spacer Upper Spring Seat Lower Spring Seat Insulator	235901	344080		KG5457			SM5003 SM5219 SM5130 SM5131			
1984-85	ALL	234004	344080		KG5457			SM5004		SB103	

## DODGE RamVan Mini Van - STRUT-PLUS

1987-88	ALL V6 Eng.	SR4019									
---------	-------------	--------	--	--	--	--	--	--	--	--	--

## DODGE Ramcharger

1976-93	4WD	344074	344086	KG5422	KG5423						
1975-93	2WD	344066	344070	KG5403	KG5413						
1974-75	4WD	344074	344070	KG5422	KG5413						

## DODGE Rampage

1982-85	ALL	234001						SM5001		SB101	
---------	-----	--------	--	--	--	--	--	--------	--	-------	--

## DODGE Royal Monaco

1975-77	ALL	343138	343159	KG4528	KG5512						
---------	-----	--------	--------	--------	--------	--	--	--	--	--	--

## DODGE Shadow

1987-94	ALL Upper Spring Seat Spacer Upper Spring Seat Lower Spring Seat Insulator	235902	343164		KG5563			SM5003 SM5219 SM5130 SM5131		SB104	
---------	---	--------	--------	--	--------	--	--	--------------------------------------	--	-------	--

## DODGE Spirit

1989-95	ALL Upper Spring Seat Spacer Upper Spring Seat Lower Spring Seat Insulator	235902	343164		KG5563			SM5003 SM5219 SM5130 SM5131		SB103	
---------	---	--------	--------	--	--------	--	--	--------------------------------------	--	-------	--

## DODGE Sprinter 2500











2003-06	Mount Bushing							SM5445			
	ALL (Exc. 118" WB, High Roof Option, Chassis Cab)	335810	349001								
	ALL w/ 118" WB & High Roof Option	335809	341339								
	ALL w/ 118" WB (Exc. High Roof Option)	335810	341339								
	ALL w/ High Roof Option or Chassis Cab (Exc. 118" WB)	335809	349001								

Notes de bas de Page 320 - Guia de notas al calce del catalogo Pg. 321

Bold part numbers indicate the most comparable KYB product to the original design & performance.  
(22) For vehicles with Electronic Susp., Leveling Control, and Air Suspensions refer to Appendix C.



# Applications For Pass. Cars, Light Trucks, SUV's, & Vans

VEHICLE MAKE, MODEL & YEAR	<b>GR-2</b>	<b>Gas-a-Just</b>	<b>MonoMax</b> 56XXXX Series	STRUT & SHOCK	
MARQUE, MODELE ET	<b>Excel-G</b>		<b>AGX</b> 7XXXX Series	MOUNTS	BOOT KITS
ANNEE DU VEHICULE	 	 	 	 	 
LA MARCA EL MODELO & AÑO					

## DODGE Van (3/4 Ton) B & Ram Series (continued)

1971-94	B200, B250 (Exc. HD) B200, B250 HD Models	344066	344073	KG5403 KG5403	KG5418 KG5418						
---------	--	--------	--------	------------------	------------------	--	--	--	--	--	--

## DODGE Van (1 Ton) B & Ram Series (Exc. Motorhome Chassis)

1999-03	3500 (Exc. w/ 9000 GVW) 3500 w/ 9000 GVW	344066	344073	KG5403 KG5403	KG5418 KG5418						
1995-98	B3500 (Exc. w/ 9000 GVW) B3500 w/ 9000 GVW	344066	344073	KG5403 KG5403	KG5418 KG5418						
1971-94	B300, B350 (Exc. w/ 4000lb. Front Axle) B300, B350 w/ 4000lb. Front Axle		344073 344073	KG5403 KG5404	KG5418 KG5418						

## DODGE Van (2WD) - Steering Stabilizer

1954-70	w/ Straight I-Beam axle Complete Kit	SS15345									
---------	---	---------	--	--	--	--	--	--	--	--	--

## DODGE Viper

1992-08	ALL	NA	NA								
---------	-----	----	----	--	--	--	--	--	--	--	--

## DODGE Vista (Canadian Vehicle)

1989-92	2WD Station Wagon 4WD Station Wagon ALL w/ Power Steering (Exc. Station Wagon) ALL w/o Power Steering (Exc. Station Wagon)	235006 235050 233025 233025		342014	KG4192 KG4192 KG3200A KG3200A			SM5061 SM5062		SB103 SB103 SB104 SB104	
---------	---	--------------------------------------	--	--------	--	--	--	------------------	--	----------------------------------	--

## DODGE W100, W150 (1/2 Ton) (4WD) Pickup

1972-93	ALL	344074	344086	KG5422	KG5423						
1963-71	ALL	344074		KG5422							

## DODGE W200, W250 (3/4 Ton) (4WD) Pickup

1972-93	ALL	344074	344086	KG5422	KG5423						
1963-71	ALL	344074		KG5422							

## DODGE W300, W350 (1Ton) (4WD) Pickup

1972-93	ALL	344074	344086	KG5422	KG5423						
1963-71	ALL	344074		KG5422							

## EAGLE 2000 GTX (Canadian Vehicle)

1991-93	ALL (Exc. 4WD) (Exc. Auto Leveling) ALL w/ 4WD	235032 235032	341114 341121			734005 734005	741013 741014	SM5091 SM5091	SB101 SB101	SB107 SB107	
---------	---	------------------	------------------	--	--	------------------	------------------	------------------	----------------	----------------	--

## EAGLE Medallion

1988-89	ALL		343220					SM5330		SB101	
---------	-----	--	--------	--	--	--	--	--------	--	-------	--

## EAGLE Premier

1988-92	ALL		343220					SM5330		SB101	
---------	-----	--	--------	--	--	--	--	--------	--	-------	--





Notes de bas de Page 320 - Guia de notas al calce del catalogo Pg. 321  
 Bold part numbers indicate the most comparable KYB product to the original design & performance.  
 (2) For vehicles with Electronic Susp., Leveling Control, and Air Suspensions refer to Appendix C.

PASSENGER CARS / VOITURES / AUTOMOVILES  
 LIGHT TRUCKS / CAMIONNETTE / CAMIONES LIGEROS

HEAVY DUTY / MOTORHOME / SERVICE INTENSIF / AUTOCARS ET  
 AUTOCARAVANES / EQUIPOS PESADOS, AUTOBUSES, Y CASAS RODANTES



# Applications For Pass. Cars, Light Trucks, SUV's, & Vans

VEHICLE MAKE, MODEL & YEAR		<b>GR-2</b> <i>Excel-G</i>		<b>Gas-a-Just</b>		<b>MonoMax</b> 56XXXX Series <b>AGX</b> 7XXXX Series		STRUT & SHOCK MOUNTS		BOOT KITS	
MARQUE, MODELE ET ANNEE DU VEHICULE											
LA MARCA EL MODELO & AÑO											

## EAGLE Summit

1993-96	Sedan	Right Hand Left Hand	234061 234062	341140 341140					SM5109 SM5109	SM5091 SM5091	SB101 SB101	SB107 SB107
1992-96	Station Wagon 2WD		235032	343262					SM5195	SM5091	SB101	SB108
1989-92	Sedan & Hatchback (FWD)		235033	341084					SM5063	SM5091	SB101	SB107

## EAGLE Talon

1995-98	AWD FWD		341163 341163	341164 341165			741042 741042	741020 741019	SM5091 SM5091	SM5091 SM5091	SB108 SB108	SB108 SB108
1990-94	AWD FWD		235032 235032	341121 341114			734005 734005	741014 741013	SM5072 SM5072	SM5091 SM5091	SB101 SB101	SB108 SB108

## EAGLE Vision

1993-97	ALL	Right Hand Left Hand	234601 234602	234603 234603					SM5110 SM5110 SM5231 SM5556	SM5111 SM5111	SB101 SB101	SB102 SB102
	Upper Spring Seat Lower Spring Seat Insulator											

## EAGLE Vista (Canadian Vehicle)

1989-92	2WD Station Wagon 4WD Station Wagon ALL w/ Power Steering (Exc. Station Wagon) ALL w/o Power Steering (Exc. Station Wagon)		235006 235050 233025 233025		342014 342014		KG4192 KG4192 KG3200A KG3200A			SM5095 SM5095 SM5061 SM5062		SB103 SB103 SB104 SB104
---------	---	--	--------------------------------------	--	------------------	--	--	--	--	--------------------------------------	--	----------------------------------

## EDSEL Citation & Corsair

1958	ALL		343127	343219	KG4515	KG5517						
------	-----	--	--------	--------	--------	--------	--	--	--	--	--	--

## EDSEL Corsair & Ranger

1959	ALL		343127		KG4515							
------	-----	--	--------	--	--------	--	--	--	--	--	--	--

## EDSEL Pacer & Ranger

1958	ALL		343127	343219	KG4515	KG5517						
------	-----	--	--------	--------	--------	--------	--	--	--	--	--	--

## EDSEL Ranger & Villager

1960	ALL		343127	343136	KG4515							
------	-----	--	--------	--------	--------	--	--	--	--	--	--	--

## EDSEL Villager

1959	ALL		343127	343136	KG4515							
------	-----	--	--------	--------	--------	--	--	--	--	--	--	--

## FIAT 124











1968-78	ALL From Chassis 066.059 (Exc.S/W)		343141	343142								
1966-76	Station Wagon		343141	344055		KG5538						
1966-68	ALL Thru Chassis 066.058 (Exc.S/W)		343141									

## FIAT 131

1979-82	Sedan			343142								
1975-78	Sedan (Exc. Sealed Struts)			343142								

Notes de bas de Page 320 - Guia de notas al calce del catalogo Pg. 321  
 Bold part numbers indicate the most comparable KYB product to the original design & performance.  
 (22) For vehicles with Electronic Susp., Leveling Control, and Air Suspensions refer to Appendix C.

# Applications For Pass. Cars, Light Trucks, SUV's, & Vans

VEHICLE MAKE, MODEL & YEAR	<b>GR-2</b> <i>Excel-G</i>	<b>Gas-a-Just</b>	<b>MonoMax</b> 56XXXX Series <b>AGX</b> 7XXXX Series	STRUT & SHOCK MOUNTS	BOOT KITS
MARQUE, MODELE ET ANNEE DU VEHICULE LA MARCA EL MODELO & AÑO	 	 	 	 	 

## FIAT 2000 (Also See Pininfarina)

1979-82	Spider	343141	343142								
---------	--------	--------	--------	--	--	--	--	--	--	--	--

## FIAT X1/9 (Also See Bertone)

1979-83	ALL	233003	233004								
1974-78	ALL	233003									

## FORD Aerostar Mini-Van

1990-97	4WD & AWD		344290	KG5499	KG5492						
1989-97	RWD	344083	344290	KG5460	KG5492	565051					
1986-88	ALL	344083	344084	KG5460	KG5461	565051					

## FORD Aspire

1994-97	ALL Strut Mount w/ Bearing							SM5040 SM5273	SM5139	SB101	
---------	-------------------------------	--	--	--	--	--	--	------------------	--------	-------	--

## FORD Bronco

1984-96	ALL (Exc. Quad Shock Option) Quad Shock Option - Frontward Mounting of the Axle	344049 344076	344077 344077	KG5440 KG5439	KG5441 KG5441	565043	565044 565044				
	Quad Shock Option - Rearward Mounting of the Axle	344049	344077	KG5440	KG5441	565043	565044				
	1980-83	ALL (Exc. Quad Shock Option) Quad Shock Option - Frontward Mounting of the Axle	344049 344076	344078 344078	KG5440 KG5439	KG5442 KG5442	565043				
	Quad Shock Option - Rearward Mounting of the Axle	344049	344078	KG5440	KG5442	565043					
1967-77	ALL	344272	344085	KG5406	KG5419		565037				
1966	ALL (From Serial# 830001)	344272	344085	KG5406	KG5419		565037				
	ALL (To Serial #830000)		344071		KG5414						

## FORD Bronco - Steering Stabilizer

1980-96	Complete Kit	SS15342									
1970-79	OEM Replacement Cylinder	SS10344									

## FORD Bronco - Lift Replacement Shocks









1984-96	ALL (Exc. Quad Shock Option) Lift = 2-3"					565078	565081				
	Quad Shock Option - Frontward Mounting of the Axle Lift = 2-3"					565080	565081				
	Quad Shock Option - Rearward Mounting of the Axle Lift = 2-3"					565078	565081				
1980-83	ALL (Exc. Quad Shock Option) Lift = 2-3"					565078					
	Quad Shock Option - Rearward Mounting of the Axle Lift = 2-3"					565078					

## FORD Bronco II

10/89-90	ALL	344268	344396	KG5489	KG5487	565001	565011				
2/89 - 9/89	ALL	344049	344396	KG5440	KG5487	565043	565011				
1984-1/89	ALL	344049	344050	KG5440	KG5454	565043					

Notes de bas de Page 320 - Guia de notas al calce del catalogo Pg. 321  
 Bold part numbers indicate the most comparable KYB product to the original design & performance.  
 (22) For vehicles with Electronic Susp., Leveling Control, and Air Suspensions refer to Appendix C.

# Applications For Pass. Cars, Light Trucks, SUV's, & Vans

VEHICLE MAKE, MODEL & YEAR	<b>GR-2</b>	<b>Gas-a-Just</b>	<b>MonoMax</b> 56XXXX Series	STRUT & SHOCK	
MARQUE, MODELE ET	<b>Excel-G</b>		<b>AGX</b> 7XXXXX Series	MOUNTS	BOOT KITS
ANNEE DU VEHICULE	 	 	 	 	 
LA MARCA EL MODELO & AÑO					

## FORD Contour

3/97-00	ALL	235620	235621					SM5138	SM5140	SB105	SB102
1995-2/97	ALL	235910	235911					SM5138	SM5140	SB105	SB102

## FORD Cougar (Canadian Vehicle)

2001-02	ALL	235620	235621					SM5138	SM5140	SB105	SB102
---------	-----	--------	--------	--	--	--	--	--------	--------	-------	-------

## FORD Country Sedan

1965-74	ALL	343128	343149	KG4515	KG5522						
1959-64	ALL	343127	343136	KG4515							
1957-58	ALL	343127	343131	KG4515	KG5526						
1952-56	ALL			KG4503	KG5517						

## FORD Country Squire

1979-91	ALL	343128	343135	KG4515	KG5521						
1965-78	ALL	343128	343149	KG4515	KG5522						
1959-64	ALL	343127	343136	KG4515							
1957-58	ALL	343127	343131	KG4515	KG5526						
1952-56	ALL			KG4503	KG5517						

## FORD Courier

1972-82	ALL	343127	344052								
---------	-----	--------	--------	--	--	--	--	--	--	--	--

## FORD Crestline

1952-54	ALL			KG4503	KG5517						
---------	-----	--	--	--------	--------	--	--	--	--	--	--

## FORD Crown Victoria

2003-10	ALL (Incl. Rear Air Spring Susp.) (Exc. Police Car & Taxi)			551600	555601 <sup>59</sup>			SM5392	SM5267		
				551602	555603 <sup>59</sup>			SM5392	SM5267		
2000-02	Police Car & Taxi	344081 <sup>32</sup>	343135	KG5458 <sup>32</sup>	KG5521			C0522 <sup>32</sup>			
1995-02	ALL (Exc. Police Car & Taxi)	344424	343135	KG5572	KG5521						
1983-99	Police Car & Taxi	344081	343135	KG5458	KG5521						
1983-94	ALL (Exc. Police Car & Taxi)	343128	343135	KG4515	KG5521						

## FORD Custom

1965-72	ALL	343128	343149								
1964	ALL	343127	343136								
1957	ALL	343127	343219								
1952	ALL			KG4503	KG5517						

## FORD Custom 500

1965-77	ALL	343128	343149								
1964	ALL	343127	343136								











## FORD Customline

1952-56	ALL			KG4503	KG5517						
---------	-----	--	--	--------	--------	--	--	--	--	--	--

<sup>32</sup> bushing kit C0522 required with [KG5458] on Police / Taxi

<sup>59</sup> Mount kit [SM5267] required with [555601], or [555603]

# Applications For Pass. Cars, Light Trucks, SUV's, & Vans

VEHICLE MAKE, MODEL & YEAR	<b>GR-2</b>	<b>Gas-a-Just</b>	<b>MonoMax</b> 56XXXX Series	STRUT & SHOCK	
MARQUE, MODELE ET	<b>Excel-G</b>		<b>AGX</b> 7XXXX Series	MOUNTS	BOOT KITS
ANNEE DU VEHICULE	 	 	 	 	 
LA MARCA EL MODELO & AÑO					

## FORD E Super Duty, E450 Econoline

1996-07	ALL			KG6413	KG6414						
---------	-----	--	--	--------	--------	--	--	--	--	--	--

## FORD E-450 Super Duty

2008-10	ALL	345080	344371	554369	KG5498		565010				
---------	-----	--------	--------	--------	--------	--	--------	--	--	--	--

## FORD Econoline (Exc. Motorhome Chassis)

2008-10	E150	345080	344371	554369	KG5498		565010				
	E250	345080	344371	554369	KG5498		565010				
	E350 Super Duty	345080	344371	554369	KG5498		565010				
2007	E150	344370	344371	KG5497	KG5498	565014	565010				
	E250	344370	344371	KG5497	KG5498	565014	565010				
1992-07	E350 (Inc. Club Wagon) (Inc. Cutaway Van) (Inc. Super Duty)			KG5497	KG5498	565014	565010				
1992-06	E150 (Inc. Club Wagon)	344388	344369	KG5495	KG5496	565012	565013				
	E250 (Inc. Club Wagon) (Exc. 8600 GVW)	344370	344371	KG5497	KG5498	565014	565010				
	E250 w/ 8600 GVW (Inc. Club Wagon)			KG5497	KG5498	565014	565010				
1975-91	E100, E150	344069	344071	KG5410	KG5414						
	E250, E350 (Inc. HD & Camper Conv.)	344272	344264	KG5406	KG5421						
1968-74	ALL		344085		KG5419		565037				
1961-67	ALL		344426	KG5438	KG5401						

## FORD Edge

2010	ALL	Right Hand		349068							SB102
		Left Hand		349068							SB102
2007-09	ALL	Right Hand	334644	349068							SB102
		Left Hand	334645	349068							SB102

## FORD Elite

1975-76	ALL		343128	343135	KG4515	KG5521					
---------	-----	--	--------	--------	--------	--------	--	--	--	--	--

## FORD Escape

2008-10	ALL	Right Hand	235912	349101 <sup>70</sup>					SM5390		SB105
		Left Hand	235913	349101 <sup>70</sup>					SM5390		SB105
2009-10	Upper Spring Seat Insulator									SM5547	
2001-07	ALL	Right Hand	235912	344356					SM5390		SB105
		Left Hand	235913	344356					SM5390		SB105
2001-08	Upper Spring Seat Insulator									SM5547	

## FORD Escort, ZX2 (Exc. Street Racer) (also see STRUT-PLUS)

1998-03	ZX2 Coupe	Right Hand	235916	234903					SM5044	SM5046	SB105	SB104
		Left Hand	235917	234904					SM5044	SM5046	SB105	SB104
	Strut Mount w/ Bearing								SM5170			
	Upper Spring Seat								SM5155			
	Lower Spring Seat Insulator									SM5430		
1997-02	ALL (Exc. ZX2 Coupe)	Right Hand	235914	234903					SM5044	SM5046	SB105	SB104
		Left Hand	235915	234904					SM5044	SM5046	SB105	SB104
	Strut Mount w/ Bearing								SM5170			
	Upper Spring Seat								SM5155			
	Lower Spring Seat Insulator									SM5430		
1991-96	ALL (Exc. ABS & 4WD)	Right Hand	234037	234039					SM5044	SM5046	SB101	SB102
		Left Hand	234038	234040					SM5044	SM5046	SB101	SB102
	Strut Mounting Kit								SM5305			











<sup>70</sup> New Part Number, Available 2nd Quarter 2011

Notes de bas de Page 320 - Guia de notas al calce del catalogo Pg. 321

Bold part numbers indicate the most comparable KYB product to the original design & performance.

(22) For vehicles with Electronic Susp., Leveling Control, and Air Suspensions refer to Appendix C.

# Applications For Pass. Cars, Light Trucks, SUV's, & Vans

VEHICLE MAKE, MODEL & YEAR	  	STRUT & SHOCK		BOOT KITS	
MARQUE, MODELE ET		MOUNTS			
ANNEE DU VEHICULE					
LA MARCA EL MODELO & AÑO					
	 	 	 	 	 

## FORD Escort, ZX2 (Exc. Street Racer) (also see STRUT-PLUS) (continued)

1991-96	Upper Spring Seat Lower Spring Seat Insulator							SM5155	SM5430		
3/1/85-90	ALL Strut Mounting Kit Strut Mount Bearing	333141	231002					SM5037 SM5270 SM5006		SB101	SB103
1983-85	ALL (Built 2/1/83 thru 3/1/85)	234018	231002							SB101	SB103
1981-90	Rear Strut Mounting Kit								SM5269		
81-Early 85	Strut Mount							SM5268			
1981-2/1/83	ALL		231002							SB101	SB103

## FORD Escort (Exc. Street Racer), ZX2 - STRUT PLUS

1998-03	ZX2 Coupe	Right Hand Left Hand		SR4014 SR4015							
1997-02	ALL (Exc. ZX2 Coupe)	Right Hand Left Hand	SR4012 SR4013	SR4014 SR4015							
1991-96	ALL (Exc. ABS & 4WD)	Right Hand Left Hand	SR4005 SR4006	SR4007 SR4008							

## FORD Excursion

2000-05	2WD 4WD	344370		KG5497 KG54330	KG54329 KG54331	565014 565098	565099				
---------	------------	--------	--	-------------------	--------------------	------------------	--------	--	--	--	--

## FORD Excursion (4WD) - Steering Stabilizer

2000-04	Complete Kit Replacement Cylinder Only	SS15489 SS10309									
---------	---	--------------------	--	--	--	--	--	--	--	--	--

## FORD Expedition (2WD)

2007-08	ALL (Exc. Air Susp.)	341671	341672								
2003-06	ALL (Exc. Air Susp.) Strut Mount (Includes Black Strut Boot) Strut Mount w/o Air Susp.	341605	341607					SM5424 SM5426	SM5536		
1997-02	ALL (Exc. Rear Air Leveling) ALL w/ Rear Air Leveling	344367 344367	344267 344377	KG54311 KG54311	KG54320 KG54319	565004 565004	565007 565005				

## FORD Expedition (4WD)

2007-08	ALL (Exc. Air Susp.)	341671	341672								
2003-06	ALL (Exc. Air Susp.) ALL Strut Mount w/ Off Road Susp. (Includes Red Strut Boot) Strut Mount w/o Off Road Susp. (Incl. Black Boot & Bumper) Strut Mount w/o Air Susp.	341606	341607					SM5425 SM5424 SM5426	SM5536		
1997-02	ALL (Exc. Four Corner Air-Leveling System)	344368	344267	KG54313	KG54320	565006	565007				











## FORD Expedition (4WD) - Lift Replacement Shocks

1997-02	ALL (Exc. Four Corner Air-Leveling System) Lift = 0-1"					565006	565007				
---------	--	--	--	--	--	--------	--------	--	--	--	--

Notes de bas de Page 320 - Guia de notas al calce del catalogo Pg. 321

Bold part numbers indicate the most comparable KYB product to the original design & performance.  
(22) For vehicles with Electronic Susp., Leveling Control, and Air Suspensions refer to Appendix C.

# Applications For Pass. Cars, Light Trucks, SUV's, & Vans

VEHICLE MAKE, MODEL & YEAR	<b>GR-2</b>	<b>Gas-a-Just</b>	<b>MonoMax</b> 56XXXX Series	STRUT & SHOCK		BOOT KITS	
MARQUE, MODELE ET	<b>Excel-G</b>		<b>AGX</b> 7XXXX Series	MOUNTS			
ANNEE DU VEHICULE	 	 	 	 	 		
LA MARCA EL MODELO & AÑO							

## FORD Explorer

2006-10	ALL	341474	341475								
2006-09	Upper Spring Seat Insulator							SM5520			
2004-05	ALL (Exc. Sport-Trac) Upper Spring Seat Insulator	341419 <sup>61</sup>	341327 <sup>61</sup>					SM5391 SM5519	SM5391		
2002-03	ALL (Exc. Sport-Trac) Upper Spring Seat Insulator	341326 <sup>61</sup>	341327 <sup>61</sup>					SM5391 SM5518	SM5391		
1995-01	ALL (Exc. Adjustable Susp.) AXLE DAMPER (Rear Quad Shock)	341302	344269 SS10201	KG54309	KG5490	561001	565003				
1991-94	ALL	344268	344269	KG5489	KG5490	565001	565003				

## FORD Explorer Sport

2001-03	2 Door Sport	341302	344269	KG54309	KG5490	561001	565003				
---------	--------------	--------	--------	---------	--------	--------	--------	--	--	--	--

## FORD Explorer Sport-Trac

2007-10	ALL	341474	341475								
2001-05	ALL	341302	344269	KG54309	KG5490	561001	565003				

## FORD F100, F150 (2WD)

2010	ALL	341674									
2009	ALL	341674	344415		KG5192						
2004-08	F150 & Super Crew (Exc. Lightning) Strut Mount (Includes Black Strut Boot)	341602	344414		KG5193			SM5424			
2004-07	Strut Boot									SB101	
2004	F150 Heritage (Exc. 7700 GVW Package)	344367	344374	KG54311	KG54312	565004					
	F150 Heritage w/ 7700 GVW Package	344367	344615	KG54311		565004					
	F150 SVT Lightning		344374	KG5042	KG54312						
2000-03	F150 Series w/ 7700 GVW Package	344367	344615	KG54311	KG54312	565004					
	F150 Super Crew	344367	344374	KG54311	KG54312	565004	565008				
1999-03	F150 SVT Lightning		344374	KG5042	KG54312	565004	565008				
1997-03	ALL (Exc. Lightning & 7700 GVW Package)	344367	344374	KG54311	KG54312	565004	565008				
	ALL (Lowered 2" / 4")					565004	565010				
1994-95	Lightning Model			KG5440	KG5441	565043	565044				
1984-96	ALL (Exc. Lightning)	344049	344077	KG5440	KG5441	565043	565044				
1980-83	ALL	344049	344078	KG5440	KG5442	565043					
1970-79	ALL	344272	344071	KG5406	KG5414						
1965-69	ALL	344272	344085	KG5406	KG5419		565037				

## FORD F100, F150 (2WD) - Steering Stabilizer

1980-96	ALL	SS15342									
---------	-----	---------	--	--	--	--	--	--	--	--	--

## FORD F100, F150 (4WD)

2009	ALL	341675									
2004-08	F150 & Super Crew Strut Mount w/o Off Road Susp. (Incl. Black Boot & Bumper)	341601	344415		KG5192			SM5424			
	Strut Mount w/ Off Road Susp. (Includes Red Strut Boot)							SM5425			
2004	F150 Heritage (Exc. 7700 GVW Package) (Exc. Off-Road Package)	344368	344375	KG54313	KG54314	565006					







<sup>61</sup> [SM5391] may be required to replace original bushings in mount

Notes de bas de Page 320 - Guia de notas al calce del catalogo Pg. 321

Bold part numbers indicate the most comparable KYB product to the original design & performance.

(22) For vehicles with Electronic Susp., Leveling Control, and Air Suspensions refer to Appendix C.

# Applications For Pass. Cars, Light Trucks, SUV's, & Vans

VEHICLE MAKE, MODEL & YEAR	  	STRUT & SHOCK		BOOT KITS	
MARQUE, MODELE ET		MOUNTS			
ANNEE DU VEHICULE					
LA MARCA EL MODELO & AÑO					
	 	 	 	 	 

## FORD F100, F150 (4WD) (continued)

2004	F150 Heritage w/ 7700 GVW Package	344368	344616	KG54313		565006				
2000-03	F150 Series w/ 7700 GVW Package	344368	344616	KG54313		565006				
1997-03	F150, F150 Super Cab & F150 Super Crew (Exc. 7700 GVW Package)	344368	344375	KG54313	KG54314	565006	565009			
1990-96	ALL (Exc. Quad Shock Option)	344049	344079	KG5440	KG5493	565043	565063			
	Quad Shock Option - Frontward Mounting of the Axle	344076	344079	KG5439	KG5493		565063			
	Quad Shock Option - Rearward Mounting of the Axle	344049	344079	KG5440	KG5493	565043	565063			
1980-89	ALL (Exc. Quad Shock Option)	344049	344077	KG5440	KG5441	565043	565044			
	Quad Shock Option - Frontward Mounting of the Axle	344076	344077	KG5439	KG5441		565044			
	Quad Shock Option - Rearward Mounting of the Axle	344049	344077	KG5440	KG5441	565043	565044			
1978-79	ALL (Exc. Quad Shock Option & Super Cab)		344264		KG5421					
	Quad Shock Option - Frontward Mounting of the Axle		344264		KG5421					
	Quad Shock Option - Rearward Mounting of the Axle		344264		KG5421					
	Super Cab		344264	KG5429	KG5421					
1977	ALL		344264		KG5421					
1970-76	ALL		344264		KG5421					

## FORD F100, F150 (4WD) - Steering Stabilizer

1980-96	w/ Coil or Leaf Spring Front Suspension	SS15342								
1971-76	w/ Front Coil Springs Complete Kit	SS15345								
1970-79	OEM Replacement Cylinder	SS10344								













## FORD F100, F150 (4WD) - Lift Replacement Shocks

2000-03	F150 Series w/ 7700 GVW Package Lift = 0-1"					565006				
1997-03	F150, F150 Super Cab & F150 Super Crew (Exc. 7700 GVW Package) Lift = 0-1"					565006	565009			
	for Edelbrock # 33986 Lift = 4-5"					565088				
	for Rancho # RS5237 Lift = 4-5"					565088				
	for Rancho # RS9237 Lift = 4-5"					565088				
	for Rancho # RSX17329 Lift = 4-5"					565088				
	for Edelbrock # 34986 Lift = 4-5"						565009			
	for Rancho # RS5238 Lift = 4-5"						565009			
1990-96	ALL (Exc. Quad Shock Option) Lift = 0-2"					565078	565063			
	Quad Shock Option - Frontward Mounting of the Axle Lift = 2 1/2-4"					565080	565063			
	Quad Shock Option - Rearward Mounting of the Axle Lift = 0-2"					565078	565063			
1980-89	ALL (Exc. Quad Shock Option) Lift = 1-3"					565078				
	Quad Shock Option - Frontward Mounting of the Axle Lift = 1-3"					565080				
	Quad Shock Option - Rearward Mounting of the Axle Lift = 1-3"					565078				

Notes de bas de Page 320 - Guia de notas al calce del catalogo Pg. 321

Bold part numbers indicate the most comparable KYB product to the original design & performance.  
(22) For vehicles with Electronic Susp., Leveling Control, and Air Suspensions refer to Appendix C.

# Applications For Pass. Cars, Light Trucks, SUV's, & Vans

VEHICLE MAKE, MODEL & YEAR	  	STRUT & SHOCK		BOOT KITS	
MARQUE, MODELE ET		MOUNTS			
ANNEE DU VEHICULE					
LA MARCA EL MODELO & AÑO					
	 	 	 	 	 

## FORD F250 (Exc. Superduty Models) (2WD)

1997-99	ALL (Less Than 8500GVW) (Exc. Rear Air Leveling)	344367	344615	KG54311		565004					
	ALL (Over 8500GVW)	344049	344077	KG5440	KG5441	565043	565044				
1980-96	ALL	344049	344077	KG5440	KG5441	565043	565044				
1973-79	ALL (Exc. Crew Cab)	344272	344071	KG5406	KG5414						
	Crew Cab	344272	344085	KG5406	KG5419		565037				
1970-72	ALL	344272	344071	KG5406	KG5414						
1965-69	ALL	344272	344085	KG5406	KG5419		565037				

## FORD F250 (2WD) - Steering Stabilizer

1980-96	ALL	SS15342									
---------	-----	---------	--	--	--	--	--	--	--	--	--

## FORD F250 (Exc. Superduty Models) (4WD)

1997-99	ALL (Less Than 8500GVW) (Exc. Rear Air Leveling)	344368	344616	KG54313		565006					
1997-98	ALL (Over 8500GVW)	344267	344079	KG54320	KG5493	565007	565063				
1992-96	ALL	344267	344079	KG54320	KG5493	565007	565063				
1987-91	ALL	344267	344079	KG54320	KG5443						
1980-86	ALL		344079	KG5456	KG5443						
1977-79	ALL From Serial No. Y20001		344264	KG5429	KG5421						

## FORD F250 (Exc. Superduty Models) (4WD) - Lift Replacement Shocks

1997-98	ALL (Less Than 8500GVW) Lift = 0-1"					565006					
	ALL (Over 8500GVW) Lift = 0-1"					565007	565063				
1992-96	ALL Lift = 0-1"					565007	565063				

## FORD F250 (4WD) - Steering Stabilizer

1997-98	Heavy Duty	SS15342									
1980-96	w/ Coil or Leaf Spring Front Suspension	SS15342									

## FORD F250 Superduty (2WD)

2005-09	ALL	344370	345072	KG5497	554366	565014	565091				
1999-04	ALL	344370	344382	KG5497	KG54332	565014	565100				

## FORD F250 Superduty (4WD)

2005-09	ALL	349004	345070	554347	555056		565091				
2003-04	ALL (Exc. 137", 156" WB and Chassis Cab)	344077	344419	KG5441	KG54333	565044	565091				
	ALL w/ 137" & 156" WB, Inc. FX4 Package	344412	344413	KG5043	KG5044						
1999-02	ALL	344077	344419	KG5441	KG54333	565044	565091				

## FORD F250 Superduty (4WD) - Steering Stabilizer

2008-09	Replacement Unit	SS10202									
2005-07	Replacement Unit	SS10322									
1999-04	Complete Kit	SS15489									
	Replacement Unit	SS10309									

Notes de bas de Page 320 - Guia de notas al calce del catalogo Pg. 321  
 Bold part numbers indicate the most comparable KYB product to the original design & performance.  
 (22) For vehicles with Electronic Susp., Leveling Control, and Air Suspensions refer to Appendix C.



# Applications For Pass. Cars, Light Trucks, SUV's, & Vans

VEHICLE MAKE, MODEL & YEAR	<b>GR-2</b>	<b>Gas-a-Just</b>	<b>MonoMax</b> 56XXXX Series	STRUT & SHOCK	
MARQUE, MODELE ET	<b>Excel-G</b>		<b>AGX</b> 7XXXX Series	MOUNTS	BOOT KITS
ANNEE DU VEHICULE					
LA MARCA EL MODELO & AÑO					

## FORD F250 Superduty (4WD) - Lift Replacement Shocks

2003-04	ALL (Exc. 137", 156" WB and Chassis Cab) Lift = 1-3"					565081					
1999-04	for Edelbrock # 63202 Lift = 2 1/2- 4" for Rancho # RS9264 Lift = 2 1/2- 4" for Rancho # RSX17341 Lift = 2 1/2- 4" for Edelbrock # 64203 Lift = 2 1/2" for Rancho # RS5012 Lift = 2 1/2" for Rancho # RS9012 Lift = 2 1/2" for Rancho # RSX17342 Lift = 2 1/2"					565090 565090 565090	565091 565091 565091 565091				

## FORD F350 (Exc. Superduty Models) (2WD)

1980-98	ALL (Exc. Motorhome & w/ Dual Rear wheels)	344049	344077	KG5440	KG5441	565043	565044				
	ALL w/ Dual Rear Wheels	344049	344078	KG5440	KG5442	565043					
1974-79	Super Cab	344272	344071	KG5406	KG5414						
1967-79	ALL (Exc. 74-79 Super Cab)	344272	344085	KG5406	KG5419		565037				

## FORD F350 (Exc. Superduty Models) (2WD) - Steering Stabilizer

1980-96	ALL	SS15342									
---------	-----	---------	--	--	--	--	--	--	--	--	--

## FORD F350 (Exc. Superduty Models) (4WD)

1985-98	ALL w/ Monobeam Front Susp. - Front ALL w/ Monobeam Front Susp. - Rear w/ Dual Rear wheels ALL w/ Monobeam Front Susp. - Rear w/ Single Rear wheels	344267	344079	KG54320	KG5443	565007	565063				
1980-85	ALL w/ Independent Front Susp.		344079	KG5456	KG5443						
1979	ALL		344264	KG5429	KG5421						

## FORD F350 (Exc. Superduty Models) (4WD) - Steering Stabilizer

1980-96	w/ Coil or Leaf Spring Front Suspension	SS15342									
---------	---	---------	--	--	--	--	--	--	--	--	--

## FORD F350 (Exc. Superduty Models) (4WD) - Lift Replacement Shocks

1985-98	ALL w/ Monobeam Front Susp. - Front Lift = 0-1"					565007					
---------	--	--	--	--	--	--------	--	--	--	--	--

## FORD F350 Superduty (2WD)













2005-09	ALL (Exc. Chassis Cab)	344370	345072	KG5497	554366	565014					
2005-08	Chassis Cab Series	344370	345071	KG5497	555053	565014					
1999-04	ALL (Exc. Chassis Cab) Chassis Cab Series	344370 344370	344382 344077	KG5497 KG5497	KG54332 KG5441	565014 565014	565100 565044				

## FORD F350 Superduty (4WD)

2008-09	ALL (Exc. Chassis Cab) Chassis Cab Series	349004 349004	344419	554347 554347	KG54333 554363						
2005-07	ALL (Incl. Dual Rear Wheels)	349004	344419	554347	KG54333		565091				
2003-04	ALL (Exc. 137", 156" WB and Chassis Cab) ALL w/ 137" & 156" WB (Exc. Chassis Cab)	344077 344412	344419 344413	KG5441 KG5043	KG54333 KG5044	565044	565091				
1999-04	Chassis Cab Series	344077	344382	KG5441	KG54332	565044	565100				
1999-02	ALL (Exc. Chassis Cab)	344077	344419	KG5441	KG54333	565044	565091				

Notes de bas de Page 320 - Guia de notas al calce del catalogo Pg. 321  
 Bold part numbers indicate the most comparable KYB product to the original design & performance.  
 (22) For vehicles with Electronic Susp., Leveling Control, and Air Suspensions refer to Appendix C.

# Applications For Pass. Cars, Light Trucks, SUV's, & Vans

VEHICLE MAKE, MODEL & YEAR	  	STRUT & SHOCK		BOOT KITS	
MARQUE, MODELE ET		MOUNTS			
ANNEE DU VEHICULE					
LA MARCA EL MODELO & AÑO					
	 	 	 	 	 

## FORD F350 Superduty (4WD) - Steering Stabilizer

2008-09	Replacement Unit	SS10202								
2005-07	Replacement Unit	SS10322								
1999-04	Complete Kit Replacement Unit	SS15489 SS10309								

## FORD F350 Superduty (4WD) - Lift Replacement Shocks

2003-04	ALL (Exc. 137", 156" WB and Chassis Cab) Lift = 1-3"					565081				
1999-04	for Edelbrock # 63202 Lift = 2 1/2- 4" for Rancho # RS9264 Lift = 2 1/2- 4" for Rancho # RSX17341 Lift = 2 1/2- 4" for Edelbrock # 64203 Lift = 2 1/2" for Rancho # RS5012 Lift = 2 1/2" for Rancho # RS9012 Lift = 2 1/2" for Rancho # RSX17342 Lift = 2 1/2"					565090 565090 565090	565091 565091 565091 565091			
1999-02	ALL Lift = 1-3"					565081				

## FORD F450 Superduty

2008-10	Cab & Chassis Crew Cab Pickup	349004 349004	344413	554347 554347	554362 KG5044					
2005-07	4WD RWD	349004 349004		554347 554347	554363 554362					
1999-04	ALL (F47 Model)			KG5441	KG5443	565044	565081			
1988-98	RWD (F47 Model)	344387	344078	KG5486	KG5442					

## FORD F450 Superduty (2WD) - Steering Stabilizer

1999-04	OEM Replacement Cylinder	SS10309								
1993-97	OEM Replacement Cylinder	SS10334								
1988-97	Complete Kit	SS10344								

## FORD F450 Superduty (4WD) - Steering Stabilizer

1999-04	OEM Replacement Cylinder	SS10309								
---------	--------------------------	---------	--	--	--	--	--	--	--	--

## FORD F550 Superduty

2008-10	ALL (Exc. Cab & Chassis) Cab & Chassis	349004 349004	344413	554347 554347	KG5044 554362					
2005-07	4WD RWD	349004 349004		554347 554347	554363 554362					
1999-04	ALL			KG5441	KG5443	565044	565081			

## FORD Fairlane

1966-70	ALL (Exc. Station Wagon) Station Wagon	343156 343156	343219 343135	KG4505 KG4505	KG5517					
1962-65	ALL		343219		KG5517					
1957-58	Retractable H/Top	343127	343131	KG4515	KG5526					
1955-56	ALL			KG4503						

## FORD Fairmont

1983	ALL	235005	343163		KG5559			SM5036		SB103
1982	ALL (Exc. TRX Susp.)	235001	343163		KG5559			SM5036		SB103
1981-82	ALL w/ TRX Susp.	235005	343163		KG5559			SM5036		SB103

Notes de bas de Page 320 - Guia de notas al calce del catalogo Pg. 321  
 Bold part numbers indicate the most comparable KYB product to the original design & performance.  
 (22) For vehicles with Electronic Susp., Leveling Control, and Air Suspensions refer to Appendix C.

# Applications For Pass. Cars, Light Trucks, SUV's, & Vans

VEHICLE MAKE, MODEL & YEAR	<b>GR-2</b>		<b>Gas-a-Just</b>		<b>MonoMax</b> 56XXXX Series		STRUT & SHOCK			
MARQUE, MODELE ET	<b>Excel-G</b>				<b>AGX</b>		MOUNTS		BOOT KITS	
ANNEE DU VEHICULE					7XXXXX Series					
LA MARCA EL MODELO & AÑO										

## FORD Fairmont (continued)

1978-81	ALL (Exc. TRX Susp.)		235001	343161		KG5551					SB103	
---------	----------------------	--	--------	--------	--	--------	--	--	--	--	-------	--

## FORD Falcon

1966-70	ALL (Exc. Station Wagon) Station Wagon		343156 343156	343219 343135	KG4505 KG4505	KG5517						
1960-65	ALL		343156	343219	KG4505	KG5517						

## FORD Festiva

1988-93	ALL	Right Hand Left Hand	232021 232022	340009 340009					SM5040 SM5040	SM5139 SM5139	SB103 SB103	
---------	-----	-------------------------	------------------	------------------	--	--	--	--	------------------	------------------	----------------	--

## FORD Fiesta

1978-80	ALL		233001								SB101	
---------	-----	--	--------	--	--	--	--	--	--	--	-------	--

## FORD Five Hundred (Exc. Self Leveling Rear Susp.)

12/5/05-07	AWD	Right Hand Left Hand	334638 334639	341462 341462								
2005-07	FWD	Right Hand Left Hand	334640 334641	341472 341473								
05-12/4/05	AWD	Right Hand Left Hand	334638 334639									

## FORD Focus (Exc. SVT Model) (also see STRUT-PLUS)

2009-10	ALL			343429								
2008	ALL	Right Hand Left Hand	334682 334683	343429 343429								
2006-07	Sedan & Hatchback Station Wagon	Right Hand Left Hand Right Hand Left Hand	334682 334683 334682 334683	343290 343290 343291 343291			741067 741067	SM5169 SM5169 SM5169 SM5169	SM5206 SM5206		SB101 SB101 SB101 SB101	
2002-04	Hatchback (SVT)							SM5169	SM5206		SB101	
2000-05	Sedan & Hatchback (Exc. SVT) Station Wagon	Right Hand Left Hand Right Hand Left Hand	333348 333349 333348 333349	343290 343290 343291 343291		733036 733037 733036 733037	741067 741067 NA NA	SM5169 SM5169 SM5169 SM5169	SM5206 SM5206		SB101 SB101 SB101 SB101	

## FORD Focus (Exc. SVT Model) - STRUT-PLUS

2000-05	Sedan & Hatchback (Exc. SVT) Station Wagon	Right Hand Left Hand Right Hand Left Hand	SR4027 SR4028 SR4027 SR4028									
---------	---	--	--------------------------------------	--	--	--	--	--	--	--	--	--

## FORD Freestar











2004-07	ALL		235921	344467							SB130	
2004-06	Mount, Spring Seat & Bearing Lower Spring Seat Insulator							SM5448 SM5463				

## FORD Freestyle

2005-07	AWD	Right Hand Left Hand	334636 334637	341462 341462								
---------	-----	-------------------------	------------------	------------------	--	--	--	--	--	--	--	--

Notes de bas de Page 320 - Guia de notas al calce del catalogo Pg. 321  
 Bold part numbers indicate the most comparable KYB product to the original design & performance.  
 (22) For vehicles with Electronic Susp., Leveling Control, and Air Suspensions refer to Appendix C.

# Applications For Pass. Cars, Light Trucks, SUV's, & Vans

VEHICLE MAKE, MODEL & YEAR		<b>GR-2</b> <i>Excel-G</i>		<b>Gas-a-Just</b>		<b>MonoMax</b> 56XXXX Series <b>AGX</b> 7XXXXX Series		STRUT & SHOCK MOUNTS		BOOT KITS	
MARQUE, MODELE ET ANNEE DU VEHICULE		 		 		 		 		 	
LA MARCA EL MODELO & AÑO											

## FORD Freestyle (continued)

2005-07	FWD	Right Hand Left Hand	334636 334637	341470 341471							
---------	-----	-------------------------	------------------	------------------	--	--	--	--	--	--	--

## FORD Fusion (AWD)

2010	ALL (Exc. Sport Series & Sport Susp.) Strut / Shock Boot Mount, Spring Seat & Bearing			344363					SM5540		SB101
2006-09	ALL Mount, Spring Seat & Bearing	Right Hand Left Hand	341405 341406	349033 349033					SM5540		SB101 SB101

## FORD Fusion (FWD)

2011	Hybrid			344363							
2010	ALL (Exc. Sport Series & Sport Susp.) Strut / Shock Boot Mount, Spring Seat & Bearing			344363					SM5540		SB101
2006-09	ALL Mount, Spring Seat & Bearing	Right Hand Left Hand	341405 341406	344363 344363					SM5540		SB101 SB101

## FORD GT

2005-06	ALL		NA	NA							
---------	-----	--	----	----	--	--	--	--	--	--	--

## FORD Galaxie

1965-74	ALL		343128	343149	KG4515	KG5522					
1960-64	ALL		343127	343136	KG4515						
1959	ALL (Exc. Retr. H/Top) Retractable H/Top		343127 343127	343219 343136	KG4515 KG4515	KG5517					

## FORD Granada

1981-82	ALL		235005	343163		KG5559			SM5036		SB103
1975-80	ALL		343133	343136							

## FORD Grand Marquis (Canadian Vehicle)

2003-06	ALL (Incl. Rear Air Spring Susp.) (Exc. Police Car & Taxi) Police Car & Taxi				551600 551602	555601 <sup>59</sup> 555603 <sup>59</sup>			SM5392 SM5392	SM5267 SM5267	
2001-02	ALL		344424	343135	KG5572	KG5521					

## FORD LTD

1983-86	ALL		235005	343163		KG5559			SM5036		SB103
1979-82	ALL		343128	343135	KG4515	KG5521					
1965-78	ALL		343128	343149	KG4515	KG5522					

## FORD LTD II

1977-79	ALL		343128	343135	KG4515	KG5521					
---------	-----	--	--------	--------	--------	--------	--	--	--	--	--











## FORD Mainline

1952-56	ALL				KG4503	KG5517					
---------	-----	--	--	--	--------	--------	--	--	--	--	--

<sup>59</sup> Mount kit [SM5267] required with [555601], or [555603]

Notes de bas de Page 320 - Guia de notas al calce del catalogo Pg. 321  
 Bold part numbers indicate the most comparable KYB product to the original design & performance.  
 (22) For vehicles with Electronic Susp., Leveling Control, and Air Suspensions refer to Appendix C.

# Applications For Pass. Cars, Light Trucks, SUV's, & Vans

VEHICLE MAKE, MODEL & YEAR	<b>GR-2</b>	<b>Gas-a-Just</b>	<b>MonoMax</b> 56XXXX Series	STRUT & SHOCK			
MARQUE, MODELE ET	<b>Excel-G</b>		<b>AGX</b> 7XXXXX Series	MOUNTS		BOOT KITS	
ANNEE DU VEHICULE	 	 	 	 	 		
LA MARCA EL MODELO & AÑO							

## FORD Marauder (Canadian Vehicle)

2003-06	ALL			551602	555603 <sup>59</sup>			SM5392	SM5267		
---------	-----	--	--	--------	----------------------	--	--	--------	--------	--	--

## FORD Maverick

1969-77	ALL	343146	343136	KG4517							
---------	-----	--------	--------	--------	--	--	--	--	--	--	--

## FORD Mustang, Mustang II

2010	ALL (Exc. SHELBY GT500)	235920									
2005-09	ALL (Exc. Bullit, GT500, GT500KR, Shelby)	235920	349026		554355						
2003-04	Mach I	235060			KG9090			SM5036			SB103
1999-04	ALL (Exc. Cobra, Bullitt & Mach I)	235060	344433		KG9023 <sup>2</sup>	734014	743021	SM5036			SB103
1994-98	ALL	235060	344433		KG9023 <sup>2</sup>	734014	743021	SM5036			SB103
1987-93	GT, LX 5.0L & Cobra LX w/ 2.3L	235009 235005	343161 343163		KG5551 KG5559	734013	743020	SM5036 SM5036			SB103 SB103
1987-89	Saleen Mustang	235009	343161		KG5551	734013	743020	SM5036			SB103
1984-02	AXLE DAMPER (Rear Quad Shock)				KG4521 <sup>23</sup>						
1984-86	SVO Model		343161		KG5551		743020	SM5036			
1983-86	ALL (Exc. SVO, GT & Special Handling) GT & Special Handling (Exc.SVO)	235005 235005	343163 343161		KG5559 KG5551		743020	SM5036 SM5036			SB103 SB103
1982	ALL (Exc. GT) GT Model		343163 343161		KG5559 KG5551		743020				SB103 SB103
1979-81	ALL		343161		KG5551		743020				SB103
1974-78	ALL (Built From 11/5/73)	343134	343148	KG4511							
1974	ALL (Built Thru 11/5/73)	343134	343137	KG4511							
1971-73	ALL (Incl. Shelby)	343156	343219	KG4504	KG5517						
1964-70	ALL (Incl. Shelby)	343146	343219	KG4517	KG5517						

## FORD Pinto

1975-80	Sedan, Coupe & Hatchback Station Wagon	343134 343134	343137	KG4511 KG4511	KG5514						
1972-74	Sedan, Coupe & Hatchback Station Wagon	343134 343134	343137	KG4511 KG4511	KG5514						
1971	ALL	343134	343137	KG4511	KG5514						

## FORD Probe (Exc. Electronically-Adjustable Suspension)

1993-7/97	ALL	Right Hand Left Hand	235601 235602	235603 235603				SM5076 SM5076 SM5308 SM5346	SM5094 SM5093	SB101 SB101	SB101 SB101
	Strut Mounting Kit Upper Spring Seat										
1993-97	Strut Mount Bearing							SM5129			
1990-92	Spring Seat (GT w/ auto trans., Exc. V6 w/ auto trans.)							SM5341			
1989-92	ALL	Right Hand Left Hand	235046 235047	235048 235048					SM5035 SM5035	SB101 SB101	SB101 SB101
	ALL (For Adapting PRC to Non-PRC Suspension)	Right Hand Left Hand	235046 <sup>c</sup> 235047 <sup>c</sup>	235606 <sup>c</sup> 235606 <sup>c</sup>						SB101 SB101	SB101 SB101
	Front Strut Mount (Manual Trans. exc. adj. Susp.)							SM5041			
	Strut Mounting Kit (Auto Trans Exc. 3.0L)							SM5300			













<sup>2</sup> The KYB replacement unit comes with a new dustcover/ bumper assembly.

<sup>23</sup> Install [KG4521] with the dustcover to the rear of the vehicle, the spacers (in box) to the inboard side of the shock, and the axle mounting bracket spread slightly (1-2mm).

<sup>59</sup> Mount kit [SM5267] required with [555601], or [555603]

<sup>c</sup> To convert from Electronic Susp - See Appendix C

# Applications For Pass. Cars, Light Trucks, SUV's, & Vans

VEHICLE MAKE, MODEL & YEAR	  	STRUT & SHOCK		BOOT KITS	
MARQUE, MODELE ET		MOUNTS			
ANNEE DU VEHICULE					
LA MARCA EL MODELO & AÑO					
	 	 	 	 	 

## FORD Probe (Exc. Electronically-Adjustable Suspension) (continued)

1989-92	Strut Mount Bearing for SM5041 Spring Seat 3.0L							SM5127 SM5343			
1989	Spring Seat GT only							SM5341			

## FORD Ranchero

1972-79	ALL	343128	343135	KG4515	KG5521						
1966-71	ALL	343156	343135	KG4505							
1960-65	ALL	343156	343219	KG4505	KG5517						
1959	ALL	343127	343136	KG4515							
1957-58	ALL	343127	343131	KG4515	KG5526						

## FORD Ranger (2WD) (Exc. High Ryder Option)

2001-09	ALL w/ Coil Spring Front Susp. (Exc. EDGE Model)	344397	344396	KG54328	KG5487		565011				
	ALL w/ Torsion Bar Front Susp., Incl. Edge Model	341302	344079	KG54309	KG5493	561001	565063				
1998-00	ALL	344397	344396	KG54328	KG5487		565011				
10/89-97	ALL	344268	344396	KG5489	KG5487	565001	565011				
2/89 - 9/89	ALL	344049	344396	KG5440	KG5487	565043	565011				
1983-1/89	ALL	344049	344050	KG5440	KG5454	565043					

## FORD Ranger (4WD) (Exc. High Ryder Option)

2002-09	ALL w/ FX4 Bilstein Suspension			KG54309	KG5493						
2002-07	ALL w/ FX4 Rancho Suspension	341302	344079	KG54309	KG5493						
1998-09	ALL (Exc. FX4)	341302	344079	KG54309	KG5493	561001	565063				
10/89-97	ALL	344268	344079	KG5489	KG5493	565001	565063				
2/89 - 9/89	ALL	344049	344079	KG5440	KG5493	565043	565063				
1983-1/89	ALL	344049	344051	KG5440	KG5455	565043					

## FORD Ranger (4WD) (Exc. High Ryder Option) - Lift Replacement Shocks

1998-06	ALL (Exc. FX4) Lift = 0-2"						565063				
10/89-97	ALL Lift = 0-2"					565082	565063				
2/89 - 9/89	ALL Lift = 0-2"					565078	565063				
1983-1/89	ALL Lift = 0-2"					565078					

## FORD Skyliner

1959	Retractable H/Top	343127	343136	KG4515							
1957-58	Retractable H/Top	343127	343131	KG4515	KG5526						

## FORD Sunliner

1952-56	ALL			KG4503	KG5517						
---------	-----	--	--	--------	--------	--	--	--	--	--	--

## FORD Taurus (also see STRUT-PLUS)











2009	AWD										
	FWD	Right Hand		341462							
		Left Hand		340012							
				340013							
2008	AWD	Right Hand	334652 <sup>70</sup>	341462							
		Left Hand	334653 <sup>70</sup>	341462							

<sup>70</sup> New Part Number, Available 2nd Quarter 2011

Notes de bas de Page 320 - Guia de notas al calce del catalogo Pg. 321

Bold part numbers indicate the most comparable KYB product to the original design & performance.  
(22) For vehicles with Electronic Susp., Leveling Control, and Air Suspensions refer to Appendix C.

# Applications For Pass. Cars, Light Trucks, SUV's, & Vans

VEHICLE MAKE, MODEL & YEAR	  	STRUT & SHOCK		BOOT KITS	
MARQUE, MODELE ET		MOUNTS			
ANNEE DU VEHICULE					
LA MARCA EL MODELO & AÑO					
	 	 	 	 	 

## FORD Taurus (also see STRUT-PLUS) (continued)

2008	FWD	Right Hand Left Hand	334652 <sup>70</sup> 334653 <sup>70</sup>	340012 340013								
2000-07	Sedan	Right Hand Left Hand	334292 334293	334294 334294					SM5113 SM5113 SM5227 SM5466	SM5055 SM5055	SB103 SB103	SB101 SB101
2000-05	Station Wagon	Right Hand Left Hand	334292 334293	344434 344434		KG5575 KG5575			SM5113 SM5113 SM5227 SM5466	SM5267 SM5267 SM5551 SM5551	SB103 SB103	
1996-99	Sedan (Exc. SHO) Station Wagon		334168 334168	334169 344432		KG5574			SM5113 SM5113 SM5227 SM5466	SM5055 SM5055 SM5551 SM5551	SB103 SB103	SB103
1991-95	Sedan (Incl. Police & SHO)		235054	334325					SM5038 SM5005 SM5415	SM5055 SM5414	SB103	SB103
1986-95	Station Wagon		235054	344271		KG5567			SM5038 SM5271 SM5005 SM5156		SB103	
1986-90	Sedan (Incl. Police & SHO)		235054	334325					SM5038 SM5272 SM5005	SM5015	SB103	SB103
	Strut Mount (Adjustable) Strut Mount Bearing Upper Spring Seat Insulator									SM5235		

## FORD Taurus - STRUT-PLUS

2000-07	Sedan	Right Hand Left Hand	SR4009 SR4010	SR4011 SR4011							
2000-05	Station Wagon	Right Hand Left Hand	SR4009 SR4010								
1996-99	Sedan (Exc. SHO) Station Wagon		SR4033 SR4033	SR4034							
1991-95	Sedan (Incl. Police & SHO)		SR4017	SR4018							
1986-95	Station Wagon		SR4017								
1986-90	Sedan (Incl. Police & SHO)		SR4017	SR4018							

## FORD Taurus X

2008-09	AWD	Right Hand Left Hand	334654 <sup>70</sup> 334655 <sup>70</sup>	341462 341462							
	FWD	Right Hand Left Hand	334654 <sup>70</sup> 334655 <sup>70</sup>	341470 341471							

## FORD Tempo

1987-91	AWD		333141						SM5037	SM5014	SB103	SB103
3/1/85-94	ALL FWD		333141	234016					SM5037	SM5014	SB103	SB103
1984-94	Front Strut Mounting Kit Strut Mount Bearing Upper Spring Seat Insulator								SM5270 SM5006	SM5347		
1984-3/1/85	ALL		234015	234016					SM5037	SM5014	SB101	SB103

<sup>70</sup> New Part Number, Available 2nd Quarter 2011

Notes de bas de Page 320 - Guia de notas al calce del catalogo Pg. 321  
 Bold part numbers indicate the most comparable KYB product to the original design & performance.  
 (22) For vehicles with Electronic Susp., Leveling Control, and Air Suspensions refer to Appendix C.

# Applications For Pass. Cars, Light Trucks, SUV's, & Vans

VEHICLE MAKE, MODEL & YEAR	<b>GR-2</b>		<b>Gas-a-Just</b>		<b>MonoMax</b> 56XXXX Series		STRUT & SHOCK			
MARQUE, MODELE ET	<b>Excel-G</b>				<b>AGX</b>		MOUNTS		BOOT KITS	
ANNEE DU VEHICULE					7XXXXX Series					
LA MARCA EL MODELO & AÑO										

## FORD Thunderbird

2002-05	ALL	341655	341656							
1989-97	ALL (Exc. Adj. Susp.) Lower Spring Seat Insulator	231015	344110					SM5187 SM5465		
1987-88	ALL (Exc. Turbo Coupe) Turbo Coupe (For Adapting PRC to Non-PRC Suspension)	235005 235008 <sup>C</sup>	343162			KG5556 KG5556 <sup>C</sup>		SM5054		SB103 SB103
1984-88	AXLE DAMPER (Rear Quad Shock)					KG4521 <sup>23</sup>				
12/80-86	ALL	235002	343162			KG5556		SM5054		SB103
1977-79	ALL	343128	343135	KG4515	KG5521					
1973-76	ALL	343128		KG4515	KG5519					
1972	ALL	343128	343135	KG4515	KG5521					
1967-71	ALL	343128	343135	KG4515	KG5522					
1959-60	ALL	343127								
1955-57	ALL	343137	343219	KG5514	KG5517					

## FORD Torino & Grand Torino

1972-76	ALL	343128	343135	KG4515	KG5521					
1968-71	ALL (Exc. Station Wagon) Station Wagon	343156 343156	343219 343135	KG4505 KG4505	KG5517					

## FORD Victoria

1952-56	ALL			KG4503	KG5517					
---------	-----	--	--	--------	--------	--	--	--	--	--

## FORD Windstar (also see STRUT-PLUS)

1997-03	ALL w/ Rear Air Spring Susp.	235903						SM5116		
1995-03	ALL w/o Rear Air Spring Lower Spring Seat Insulator	235903	344291		KG54310			SM5116 SM5463		
1999-03	Strut Boot									SB130

## FORD Windstar - STRUT-PLUS

1995-03	ALL (Exc. Self leveling)	SR4016								
---------	--------------------------	--------	--	--	--	--	--	--	--	--

## FREIGHTLINER Sprinter 2500

2002-06	Mount Bushing							SM5445		
	ALL (Exc. 118" WB, High Roof Option, Chassis Cab)	335810	349001							
	ALL w/ 118" WB & High Roof Option	335809	341339							
	ALL w/ 118" WB (Exc. High Roof Option)	335810	341339							
	ALL w/ High Roof Option or Chassis Cab (Exc. 118" WB)	335809	349001							

## FREIGHTLINER Sprinter 3500

2002-06	Mount Bushing							SM5445		
	ALL (Exc. High Roof Option, Dual Rear Wheels, Chassis Cab)	335810	349001							
	ALL w/ Dual Rear Wheels & High Roof Option or Chassis Cab	335809	344409							
	ALL w/ Dual Rear Wheels (Exc. High Roof Option, Chassis Cab)	335810	344409							
	ALL w/ High Roof Option or Chassis Cab (Exc. Dual Rear Wheels)	335809	349001							

<sup>23</sup> Install [KG4521] with the dustcover to the rear of the vehicle, the spacers (in box) to the inboard side of the shock, and the axle mounting bracket spread slightly (1-2mm).

<sup>C</sup> To convert from Electronic Susp - See Appendix C











Notes de bas de Page 320 - Guia de notas al calce del catalogo Pg. 321

Bold part numbers indicate the most comparable KYB product to the original design & performance.

(22) For vehicles with Electronic Susp., Leveling Control, and Air Suspensions refer to Appendix C.



# Applications For Pass. Cars, Light Trucks, SUV's, & Vans

VEHICLE MAKE, MODEL & YEAR		  	STRUT & SHOCK		BOOT KITS	
MARQUE, MODELE ET			MOUNTS			
ANNEE DU VEHICULE						
LA MARCA EL MODELO & AÑO						
		 	 	 	 	 

## GEO Metro (Also See Chevrolet)

1996-97	ALL	Right Hand Left Hand	232025 232026					SM5188 SM5188	SM5189 SM5189	SB103 SB103	SB101 SB101
1989-95	ALL w/ Front Brake Bracket on Strut mounting bracket	Right Hand Left Hand	232025 232026	232027 232027				SM5188 SM5188	SM5189 SM5189	SB103 SB103	SB101 SB101

## GEO Prizm (Also See Chevrolet)

1993-97	ALL	Right Hand Left Hand	234057 234058	234059 234060				SM5049 SM5049	SM5075 SM5074	SB103 SB103	SB102 SB102
1989-92	ALL	Right Hand Left Hand	234035 234036	234031 234032				SM5049 SM5049	SM5075 SM5074	SB103 SB103	SB102 SB102

## GEO Spectrum (Also See Chevrolet)

1989	ALL	Right Hand Left Hand	232015 232016		KG4542 KG4542			SM5297 SM5297		SB102 SB102	
------	-----	-------------------------	------------------	--	------------------	--	--	------------------	--	----------------	--

## GEO Storm

1990-93	ALL From: VIN # - L7513805	Right Hand Left Hand	234041 234042	232033 232034				SM5081 SM5081	SM5105 SM5105	SB102 SB102	SB101 SB101
1989-90	ALL Thru VIN # - L7513804	Right Hand Left Hand	234041 234042	232023 232024				SM5081 SM5081	SM5105 SM5105	SB102 SB102	SB101 SB101

## GEO Tracker (Also See Chevrolet)

1996-98	ALL w/ 4 Wheel ABS	Right Hand Left Hand	334195 334196	343247 343247		KG4745A KG4745A		SM5082 SM5082			
1989-98	ALL (Exc. 4 Wheel ABS)	Right Hand Left Hand	235035 235036	343247 343247		KG4745A KG4745A		SM5082 SM5082			

## GMC C & K Series Pickups (See Sierra)

			----	----							
--	--	--	------	------	--	--	--	--	--	--	--

## GMC Caballero

1978-87	ALL		343127	343157 <sup>25</sup>	KG4513	KG5548 <sup>25</sup>					
---------	-----	--	--------	----------------------	--------	----------------------	--	--	--	--	--

## GMC Acadia

2007-10	Strut / Shock Boot									SB101	
---------	--------------------	--	--	--	--	--	--	--	--	-------	--

## GMC Canyon (2WD)

2004-09	ALL w/ Off-Road Package		344465	344466	KG5781	KG5190					
	ALL w/o Off-Road Package		341374	344464		KG5191					
2004-05	Upper Spring Seat Insulator							SM5413			

## GMC Canyon (4WD)

2004-09	ALL w/ Off-Road Package				KG5781	KG5190					
	ALL w/o Off-Road Package		344465	344466	KG5781	KG5190					













## GMC Envoy (2WD)

2008	ALL			343395		KG4162					
2002-09	Mount w/ Spring Insulator							SM5395			
	Lower Spring Seat Insulator							SM5548			
2002-07	ALL		331043 <sup>81</sup>	343395		KG4162				SB108	
2000-01	ALL		344040	344041	KG5450	KG5451	565046	565047			

<sup>25</sup> Eliminates OEM airshocks. See appendix B for special instructions.

<sup>81</sup> Replaces [331016], when stock is depleted

# Applications For Pass. Cars, Light Trucks, SUV's, & Vans

VEHICLE MAKE, MODEL & YEAR	  	STRUT & SHOCK		BOOT KITS	
MARQUE, MODELE ET		MOUNTS			
ANNEE DU VEHICULE					
LA MARCA EL MODELO & AÑO					
	 	 	 	 	 

## GMC Envoy (4WD)

2008	ALL		343395		KG4162					
2007	ALL	331043 <sup>81</sup>	343395		KG4162					SB108
2002-09	Mount w/ Spring Insulator Lower Spring Seat Insulator							SM5395 SM5548		
2002-06	ALL	331043 <sup>81</sup>	343395		KG4162					SB108
1998-01	ALL 4 Door (Exc. Auto Leveling)	344042	344041	KG5452	KG5451	565048	565047			

## GMC Envoy (4WD) Lift Replacement Shocks

1998-01	ALL 4 Door (Exc. Auto Leveling) Lift = 0-2"					565075	565047			
---------	---	--	--	--	--	--------	--------	--	--	--

## GMC Envoy XL, XUV (2WD & 4WD)

2003-06	ALL Strut Mount w/ Insulator Lower Spring Seat Insulator	331043 <sup>81</sup>	343395		KG4162			SM5395 SM5548		SB108
---------	--	----------------------	--------	--	--------	--	--	------------------	--	-------

## GMC G-Series (1/2 Ton) Van

1978-95	ALL	344068	344075	KG5409	KG5430	565032	565039			
1971-77	ALL	344068		KG5409	KG5417	565032				
1967-70	ALL		344085		KG5419		565037			
1964-66	ALL				KG5416					

## GMC G-Series (3/4 Ton) Van

1978-95	ALL	344068	344075	KG5409	KG5430	565032	565039			
1971-77	ALL	344068		KG5409	KG5417	565032				
1967-70	ALL		344085		KG5419		565037			

## GMC G-Series Van (1 Ton) (Exc. Motorhome Chassis)

1993-96	G3500 HD w/ Straight Front Axle, Leaf Spring (P42, P62)	345030	344366	KG6001A	KG5420		565038			
	G3500 HD w/ Independent Front, Coil Spring (P42, P62)		344366	KG6412	KG5420		565038			
1978-95	ALL (Exc. Dual Rear Wheels & HD) ALL w/ Dual Rear Wheels	344068 344068	344075	KG5409 KG5409	KG5430 KG5488	565032 565032	565039			
1971-77	ALL	344068		KG5409	KG5417	565032				

## GMC Jimmy - Full Size (2WD) (Exc. S-Series)









1973-82	ALL	344068	344072	KG5409	KG5415	565032	565036			
1969-72	w/ Coil Spring	344068		KG5409	KG5416	565032				
	w/ Leaf Spring	344068	344085	KG5409	KG5419	565032	565037			

## GMC Jimmy - Full Size (4WD) (Exc. S-Series)

1985-91	w/ Dual Front Shocks-Inside Shock		344072	KG5477	KG5415	565039	565036			
	w/ Dual Front Shocks-Outside Shock	344067	344072	KG5408	KG5415	565031	565036			
1980-84	w/ Dual Front Shocks-Inside Shock	344075	344072	KG5430	KG5415	565039	565036			
	w/ Dual Front Shocks-Outside Shock	344067	344072	KG5408	KG5415	565031	565036			
1973-91	ALL (Exc. w/ Dual Front Shocks)	344067	344072	KG5408	KG5415	565031	565036			
1969-72	ALL	344067		KG5408	KG5417	565031				

<sup>81</sup> Replaces [331016], when stock is depleted

# Applications For Pass. Cars, Light Trucks, SUV's, & Vans

VEHICLE MAKE, MODEL & YEAR	  	STRUT & SHOCK		BOOT KITS	
MARQUE, MODELE ET		MOUNTS			
ANNEE DU VEHICULE					
LA MARCA EL MODELO & AÑO					
	 	 	 	 	 

## GMC Jimmy - Full Size (4WD) Steering Stabilizer

1973-91	OEM Replacement Cylinder	SS10325								
---------	--------------------------	---------	--	--	--	--	--	--	--	--

## GMC Jimmy (S-Series), S15 Jimmy (2WD)

1995-05	ALL (Incl. ZQ8 Sport Susp.)	344040	344041	KG5450	KG5451	565046	565047				
1983-05	ALL (Lowered 2" / 4")					565046	565064				
1983-94	ALL (Incl. ZQ8 Sport Susp.)	344040	344041	KG5450	KG5451	565046	565047				

## GMC Jimmy (S-Series), S15 Jimmy (4WD)

1995-03	ALL w/ ZR2 HighRider Package	344042		KG5452		565048					
1994-05	ALL (Exc. ZR2 HighRider Package)	344042	344041	KG5452	KG5451	565048	565047				
1983-94	ALL	344042	344041	KG5452	KG5451	565048	565047				

## GMC P1000, P1500

1974-84	ALL	344068	344366	KG5409	KG5420	565032	565038				
1973	ALL	344068	344072	KG5409	KG5415	565032	565036				
1967-72	ALL	344068		KG5409	KG5416	565032					
1963-66	ALL	344068	344085	KG5409	KG5419	565032	565037				

## GMC P2500

1982-91	ALL	344068	344366	KG5409	KG5420	565032	565038				
1973-81	ALL	344068	344072	KG5409	KG5415	565032	565036				
1968-72	ALL	344068	344085	KG5409	KG5419	565032	565037				

## GMC P3500 (Exc. Motorhome Chassis)

1985-01	ALL (Exc. Monobeam Front Susp. & Camper Conversion) w/ Camper Conversion (Exc. Monobeam Front Susp.) w/ Monobeam Front Susp., Including Camper Conversion	344068	344366 344366 344366	KG5409	KG5420 KG5420 KG5420	565032	565038 565038 565038				
1973-84	ALL Incl. Camper Conversion	344068	344366	KG5409	KG5420	565032	565038				
1968-72	ALL (Exc. w/ 157" WB & 11,000lb. Axle) w/ 157" WB & 11,000lb. Axle	344068 344068	344085	KG5409 KG5409	KG5419 KG5417	565032 565032	565037				

## GMC P-Series Motorhome Chassis - Steering Stabilizer

1975-01	P30 GM Motorhome Chassis- OEM Replacement (Replaces DELCO #4984838)	SS10329									
---------	---	---------	--	--	--	--	--	--	--	--	--

## GMC Safari (2WD)











1996-05	ALL	344081	344082	KG5458	KG5459	565049	565050				
1990-95	ALL	344081	344082	KG5458	KG5459	565049	565050				
1985-89	ALL	344081	344082	KG5458	KG5459	565049	565050				
1985-04	ALL (Lowered 2" / 4")					565049	565037				

## GMC Safari (AWD)

1996-05	ALL	344266	344082	KG5480	KG5459	565062	565050				
1990-95	ALL	344266	344082	KG5480	KG5459	565062	565050				

Notes de bas de Page 320 - Guia de notas al calce del catalogo Pg. 321  
 Bold part numbers indicate the most comparable KYB product to the original design & performance.  
 (22) For vehicles with Electronic Susp., Leveling Control, and Air Suspensions refer to Appendix C.

# Applications For Pass. Cars, Light Trucks, SUV's, & Vans

VEHICLE MAKE, MODEL & YEAR		<b>GR-2</b> <i>Excel-G</i>		<b>Gas-a-Just</b>		<b>MonoMax</b> 56XXXX Series <b>AGX</b> 7XXXX Series		STRUT & SHOCK MOUNTS		BOOT KITS	
MARQUE, MODELE ET ANNEE DU VEHICULE		 		 		 		 		 	
LA MARCA EL MODELO & AÑO											

## GMC Savana 1500 (1/2 Ton) Van

2003-10	2WD AWD	344481 341343	344483 344483	KG5780 KG5040	KG5188 KG5188		565033 565033				
1996-02	ALL	344265	344273	KG5478	KG54100	565060	565033				

## GMC Savana 2500 (3/4 Ton) Van

2003-10	ALL (Exc. 7300 GVW)	349046	349009	554356	554348						
2003-07	ALL w/ 7300 GVW	344481	344273	KG5780	KG54100		565033				
1996-02	ALL (Including 8600 GVW)	344265	344273	KG5478	KG54100	565060	565033				

## GMC Savana 3500 (1 Ton) Van

2006-10	ALL (Exc. Cutaway Chassis) Cutaway Chassis w/ Lowered rear Leaf Susp.	349046 349046	349009 344483	554356 554356	554348 KG5188						
2003-05	ALL w/ Dual Rear Wheels ALL w/ Single Rear Wheels	349046 349046	344263 344262	554356 554356	KG5188 KG5188		565061 565034				
1996-02	ALL w/ Dual Rear Wheels ALL w/ Single Rear Wheels	344265 344265	344273 344262	KG5478 KG5478	KG54100 KG54101	565060 565060	565033 565034				













## GMC Sierra, C & R - Series 1/2 Ton (2WD)

2010	Sierra 1500 w/o Electronic Susp.							SM5530		SB129	
2007-09	Sierra 1500 (Exc. Classic Series, HD & Electronic Susp.)	341493	345074	551121	555055			SM5530		SB129	
2007	Sierra Classic 1500 (Exc. HD, Crew Cab, Elec. Susp. & Quadrateer) Sierra 1500HD Crew Cab w/ Torsion Bar Front Susp. (Exc. Elec. Susp. & Quadrateer)	344380 344383	344365 344385	KG54326 KG54340	KG54104 KG54342	565066 565102	565016 565104				
2005-06	Sierra 1500HD Crew Cab (Exc. Elec. Susp. & Quadrateer)	344383	344385	KG54340	KG54342	565102	565104				
2004-06	Sierra 1500 Crew Cab w/ Coil Spring Front Susp. (Exc. Elec. Susp. & Quadrateer)	344402	344385	KG54339	KG54342	565101	565104				
2004	Sierra 1500 Crew Cab w/ Torsion Bar Front Susp. (Exc. Elec. Susp. & Quadrateer)	344381	344386	KG54327	KG54341	565067	565103				
2001-03	Sierra 1500HD Crew Cab w/ Coil Spring Front Susp. (Exc. Electronic Ride Control) Sierra 1500HD Crew Cab w/ Torsion Bar Front Susp. (Exc. Elec. Susp. & Quadrateer)	344402 344383	344385 344385	KG54339 KG54340	KG54342 KG54342	565101 565102	565104 565104				
1999-06	Sierra 1500 (Exc. HD, Crew Cab, Elect. Susp. & Quadrateer)	344380	344365	KG54326	KG54104	565066	565016				
1999	C1500 C1500 (Lowered 2" / 4")	344265	344263	KG5478	KG5479	565060 565060	565061 565033				
1988-98	C1500 C1500 (Lowered 2" / 4")	344265	344263	KG5478	KG5479	565060 565060	565061 565033				
1987	R1500	344068	344072	KG5409	KG5415	565032	565036				
1973-86	C15, C1500	344068	344072	KG5409	KG5415	565032	565036				
1967-72	C15, C1500 w/ Coil Spring C15, C1500 w/ Leaf Spring	344068 344068	344085	KG5409 KG5409	KG5416 KG5419	565032 565032	565037				
1963-66	ALL	344068	344085	KG5409	KG5419	565032	565037				

Notes de bas de Page 320 - Guia de notas al calce del catalogo Pg. 321  
 Bold part numbers indicate the most comparable KYB product to the original design & performance.  
 (22) For vehicles with Electronic Susp., Leveling Control, and Air Suspensions refer to Appendix C.



# Applications For Pass. Cars, Light Trucks, SUV's, & Vans

VEHICLE MAKE, MODEL & YEAR	  	STRUT & SHOCK		BOOT KITS	
MARQUE, MODELE ET		MOUNTS			
ANNEE DU VEHICULE					
LA MARCA EL MODELO & AÑO					
	 	 	 	 	 

## GMC Sierra, C & R - Series 3/4 Ton (2WD) (continued)

1963-66	ALL	344068	344085	KG5409	KG5419	565032	565037				
---------	-----	--------	--------	--------	--------	--------	--------	--	--	--	--

## GMC Sierra, K & V - Series (3/4 Ton) (4WD)

2005-10	Sierra 2500HD	344383	344385	KG54340	KG54342	565102	565104				
2000-04	Sierra 2500HD (9200 GVW)	344383	344385	KG54340	KG54342	565102	565104				
1999-04	Sierra 2500 (up to 8600 GVW) (Exc. QuadraSteer)	344383	344385	KG54340	KG54342	565102	565104				
1999-00	K2500	344266	344263	KG5480	KG5479	565062	565061				
1987-98	K2500	344266	344263	KG5480	KG5479	565062	565061				
1987	V2500 (Exc. w/ Dual Front Shocks)	344067	344072	KG5408	KG5415	565031	565036				
	V2500 w/ Dual Front Shocks - inside shock		344072	KG5477	KG5415	565039	565036				
	V2500 w/ Dual Front Shocks - outside shock	344067	344072	KG5408	KG5415	565031	565036				
1985-86	K2500 w/ Dual Front Shocks - outside shock	344067	344072	KG5408	KG5415	565031	565036				
	K2500 w/ Dual Front Shocks - inside shock		344072	KG5477	KG5415	565039	565036				
1980-84	K2500 w/ Dual Front Shocks - inside shock	344075	344072	KG5430	KG5415	565039	565036				
	K2500 w/ Dual Front Shocks - outside shock	344067	344072	KG5408	KG5415	565031	565036				
1973-86	K2500 (Exc. w/ Dual Front Shocks)	344067	344072	KG5408	KG5415	565031	565036				
1969-72	ALL	344067		KG5408	KG5417	565031					

## GMC Sierra, K & V - Series (3/4 Ton) (4WD) Steering Stabilizer

2002-05	2500HD OEM Replacemant Cylinder	SS10318									
1988-04	Complete Kit	SS15326									
1988-98	w/ OE Unit (Cylinder only)	SS10317									
1973-87	OEM Replacement Cylinder	SS10325									

## GMC Sierra, C & R - Series (1 Ton) (2WD)













2007-10	Sierra 3500HD	344383	344384	KG54340	KG54341	565102	565103				
2001-07	Sierra 3500, Incl. Chassis Cab & Classic (11400 GVW)	344383	344384	KG54340	KG54341	565102	565103				
1999-00	C3500 (Exc. HD Series) C3500 (Lowered 2" / 4") (Exc. HD Series)	344265	344263	KG5478	KG5479	565060 565060	565061 565033				
1991-03	C3500 HD Series w/ I-Beam Front Axle		344263	KG54307	KG5479		565061				
1988-98	C3500 (Exc. HD Series) C3500 (Lowered 2" / 4") (Exc. HD Series)	344265	344263	KG5478	KG5479	565060 565060	565061 565033				
1987-91	R3500	344068	344366	KG5409	KG5420	565032	565038				
1973-86	C3500	344068	344366	KG5409	KG5420	565032	565038				
1967-72	C3500 (Exc. w/ 157" WB & 11,000lb. Axle)	344068	344085	KG5409	KG5419	565032	565037				
	C3500 w/ 157" WB & 11,000lb. Axle	344068		KG5409	KG5417	565032					

Notes de bas de Page 320 - Guia de notas al calce del catalogo Pg. 321  
 Bold part numbers indicate the most comparable KYB product to the original design & performance.  
 (2) For vehicles with Electronic Susp., Leveling Control, and Air Suspensions refer to Appendix C.

PASSENGER CARS / VOITURES / AUTOMOVILES  
 LIGHT TRUCKS / CAMIONNETTE / CAMIONES LIGEROS

HEAVY DUTY / MOTORHOME / SERVICE INTENSIF / AUTOCARS ET  
 AUTOCARAVANES / EQUIPOS PESADOS, AUTOBUSES, Y CASAS RODANTES

# Applications For Pass. Cars, Light Trucks, SUV's, & Vans

VEHICLE MAKE, MODEL & YEAR	  	STRUT & SHOCK		BOOT KITS	
MARQUE, MODELE ET		MOUNTS			
ANNEE DU VEHICULE					
LA MARCA EL MODELO & AÑO					
	 	 	 	 	 

## GMC Sierra, K & V - Series (1 Ton) (4WD)

2007-10	Sierra 3500HD	344383	344384	KG54340	KG54341	565102	565103				
2001-07	Sierra 3500, Incl. Chassis Cab & Classic (11400 GVW)	344383	344384	KG54340	KG54341	565102	565103				
1987-00	K3500	344266	344263	KG5480	KG5479	565062	565061				
1987-91	V3500		344386	KG5481	KG5482	565069	565068				
1977-86	K3500		344386	KG5481	KG5482	565069	565068				

## GMC Sierra, K & V Series (1Ton) (4WD) Steering Stabilizer

1973-87	OEM Replacement Cylinder	SS10325									
---------	--------------------------	---------	--	--	--	--	--	--	--	--	--

## GMC K1500, K2500, K3500 (Exc. Sub. & Elect. Ride Control Susp.) Lift Repl. Shocks

1988-99	ALL Lift = 1-3" for Edelbrock # 6360 Lift = 4-6" for Rancho # RS5244 Lift = 4-6" for Rancho # RS9244 Lift = 4-6" for Rancho # RSX17316 Lift = 4-6" for Edelbrock # 63003 Lift = 4-6" for Edelbrock # 6460 Lift = 4-6" for Rancho # RS5227 Lift = 4-6" for Rancho # RS9227 Lift = 4-6" for Rancho # RSX17315 Lift = 4-6"					565073 565086 565092 565092 565086	565074				
							565087 565087 565087 565087 565087				

## GMC Sierra 1500 (4WD) (Exc. Crew Cab & Adj. Susp., QuadraSteer) Lift Replacement Shocks

2007	Sierra Classic 1500 (Exc. HD, Crew Cab, Elec. Susp. & QuadraSteer) Lift = 1-4"					565076	565077				
1999-07	Sierra 1500 (w/ Z-71 Off Road Package) Lift = 1-4"					565076	565077				
1999-06	ALL Lift = 1-4" for Edelbrock # 63005 Lift = 4" for Edelbrock # 63008 Lift = 4" for Rancho # RS9268 Lift = 4" for Rancho # RSX17337 Lift = 4" for Edelbrock # 6405 Lift = 4" for Edelbrock # 6408 Lift = 4" for Rancho # RS9268 Lift = 4" for Rancho # RSX17338 Lift = 4"					565076 565076 565076 565076 565076	565077				
1999-00	Sierra Classic K1500, K2500, K3500 (Exc. Suburban) Lift = 1-3"					565073	565074				

## GMC Sprint

1971-77	ALL	343127	343157 <sup>25</sup>	KG4513	KG5504 <sup>25</sup>						
---------	-----	--------	----------------------	--------	----------------------	--	--	--	--	--	--

## GMC S-Series Pickup, Sonoma (2WD)

1995-04	ALL (Incl. ZQ8 Sport Susp.)	344040	344041	KG5450	KG5451	565046	565047				
1982-04	ALL (Lowered 2" / 4")					565046	565064				
1982-94	ALL (Incl. ZQ8 Sport Susp.)	344040	344041	KG5450	KG5451	565046	565047				

## GMC S-Series Pickup, Sonoma (4WD)

1994-04	ALL (Exc. ZR2 HighRider Package)	344042	344041	KG5452	KG5451	565048	565047				
1994-03	ALL w/ ZR2 HighRider Package	344042		KG5452		565048					
1982-93	S15, Sonoma	344042	344041	KG5452	KG5451	565048	565047				













<sup>25</sup> Eliminates OEM airshocks. See appendix B for special instructions.

Notes de bas de Page 320 - Guia de notas al calce del catalogo Pg. 321

Bold part numbers indicate the most comparable KYB product to the original design & performance.

(22) For vehicles with Electronic Susp., Leveling Control, and Air Suspensions refer to Appendix C.

# Applications For Pass. Cars, Light Trucks, SUV's, & Vans

VEHICLE MAKE, MODEL & YEAR	  	STRUT & SHOCK		BOOT KITS	
MARQUE, MODELE ET		MOUNTS			
ANNEE DU VEHICULE					
LA MARCA EL MODELO & AÑO					
	 	 	 	 	 

## GMC S-Series Pickup (4WD) - Lift Replacement Shocks

1982-05	ALL Lift = 1-3"					565075					
---------	-----------------	--	--	--	--	--------	--	--	--	--	--

## GMC Syclone, Typhoon

1991-93	ALL			KG5452	KG5451	565048	565047				
---------	-----	--	--	--------	--------	--------	--------	--	--	--	--

## GMC Suburban (1/2 Ton) (2WD) C & R Series

1992-99	C1500	344265	344273	KG5478	KG54100	565060	565033				
1987-91	R1500	344068	344072	KG5409	KG5415	565032	565036				
1973-86	ALL	344068	344072	KG5409	KG5415	565032	565036				
1967-72	ALL	344068		KG5409	KG5416	565032					
1963-66	ALL	344068	344085	KG5409	KG5419	565032	565037				

## GMC Suburban (1/2 Ton) (4WD) K & V Series

1992-99	K1500	344266	344262	KG5480	KG54101	565062	565034				
1987-91	V1500 (Exc. w/ Dual Front Shocks)	344067	344072	KG5408	KG5415	565031	565036				
	V1500 w/ Dual Front Shocks - inside shock			KG5477	KG5415	565039	565036				
	V1500 w/ Dual Front Shocks - outside shock			KG5408	KG5415	565031	565036				
1985-86	K1500 w/ Dual Front Shocks - inside shock		344072	KG5477	KG5415	565039	565036				
1980-84	K1500 w/ Dual Front Shocks - inside shock	344075	344072	KG5430	KG5415	565039	565036				
1980-86	K1500 w/ Dual Front Shocks - outside shock	344067	344072	KG5408	KG5415	565031	565036				
1973-86	K1500 (Exc. w/ Dual Front Shocks)	344067	344072	KG5408	KG5415	565031	565036				
1969-72	ALL	344067		KG5408	KG5417	565031					

## GMC Suburban (3/4 Ton) (2WD) C & R Series

1992-99	C2500	344265	344273	KG5478	KG54100	565060	565033				
1987-91	R2500	344068	344072	KG5409	KG5415	565032	565036				
1973-86	ALL	344068	344072	KG5409	KG5415	565032	565036				
1967-72	ALL	344068		KG5409	KG5416	565032					
1963-66	ALL	344068	344085	KG5409	KG5419	565032	565037				









## GMC Suburban (3/4 Ton) (4WD) K & V Series

1992-99	K2500	344266	344262	KG5480	KG54101	565062	565034				
1987-91	V2500 (Exc. w/ Dual Front Shocks)	344067	344072	KG5408	KG5415	565031	565036				
	V2500 w/ Dual Front Shocks - inside shock			KG5477	KG5415	565039	565036				
	V2500 w/ Dual Front Shocks - outside shock			KG5408	KG5415	565031	565036				
1985-86	K2500 w/ Dual Front Shocks - inside shock		344072	KG5477	KG5415	565039	565036				
1980-84	K2500 w/ Dual Front Shocks - inside shock	344075	344072	KG5430	KG5415	565039	565036				
1980-86	K2500 w/ Dual Front Shocks - outside shock	344067	344072	KG5408	KG5415	565031	565036				
1973-86	K2500 (Exc. w/ Dual Front Shocks)	344067	344072	KG5408	KG5415	565031	565036				
1969-72	ALL	344067		KG5408	KG5417	565031					

Notes de bas de Page 320 - Guia de notas al calce del catalogo Pg. 321  
 Bold part numbers indicate the most comparable KYB product to the original design & performance.  
 (2) For vehicles with Electronic Susp., Leveling Control, and Air Suspensions refer to Appendix C.



# Applications For Pass. Cars, Light Trucks, SUV's, & Vans

VEHICLE MAKE, MODEL & YEAR	  	STRUT & SHOCK	BOOT KITS	
MARQUE, MODELE ET				MOUNTS
ANNEE DU VEHICULE				
LA MARCA EL MODELO & AÑO				
	    			

## GMC Suburban (4WD) Steering Stabilizer

1993-98	Complete Kit w/ OE Unit (Cylinder only)	SS15326 SS10317								
1973-92	OEM Replacement Cylinder	SS10325								

## GMC Suburban (4WD) Lift Replacement Shocks

1992-99	ALL Lift = 1-3" for Edelbrock # 6360 Lift = 4-6" for Rancho # RS5244 Lift = 4-6" for Rancho # RS9244 Lift = 4-6" for Rancho # RSX17316 Lift = 4-6" for Edelbrock # 63003 Lift = 4-6" for Edelbrock # 6460 Lift = 4-6" for Rancho # RS5227 Lift = 4-6" for Rancho # RS9227 Lift = 4-6" for Rancho # RSX17315 Lift = 4-6"					565073 565086 565092 565092 565086	565061     565093 565087 565093 565093 565093				
---------	--	--	--	--	--	--	--	--	--	--	--

## GMC Tracker

1996-98	ALL w/ 4 Wheel ABS	Right Hand Left Hand	334195 334196	343247 343247		KG4745A KG4745A			SM5082 SM5082		
1989-98	ALL (Exc. ABS)	Right Hand Left Hand	235035 235036	343247 343247		KG4745A KG4745A			SM5082 SM5082		

## GMC Yukon (2WD)













2007-09	ALL (Exc. Electronic, ZW7 Premium Smooth Ride Susp. & Police Package)		341493	345073	551121	555054			SM5530		SB129
2001-06	ALL (Exc. Z55 Autoride Susp. or ZW7 Premium Smooth Ride Susp.) ALL w/ ZW7 Premium Smooth Ride Susp. (Exc. Z55 Autoride Susp.)		344381 341343	344384 SR2003	KG54327 KG5040	KG54341	565067	565103			
2000	ALL 4 Door (New Style) (Exc. Z55 Autoride Susp. or Premium Smooth Ride Susp.) ALL 4 Door (New Style) w/ Premium Smooth Ride Susp. (Exc. Z55 Autoride Susp.) ALL (Old Style)		344381 341343 344265	344384 SR2003	KG54327 KG5040	KG54341	565067	565103			
1995-99	4 Door 2 Door 2 Door (Lowered 2" / 4")		344265 344265	344273 344263	KG5478 KG5478	KG54100 KG5479	565060 565060 565060	565033 565061 565033			

## GMC Yukon (4WD)

2007-09	ALL (Exc. Electronic, ZW7 Premium Smooth Ride Susp. & Police Package)		341493	345073	551121	555054			SM5530		SB129
2001-06	ALL (Exc. Z55 Autoride Susp. or ZW7 Premium Smooth Ride Susp.) ALL w/ ZW7 Premium Smooth Ride Susp. (Exc. Z55 Autoride Susp.)		344381 341343	344384 SR2003	KG54327 KG5040	KG54341	565067	565103			
2000	ALL 4 Door (New Style) (Exc. Z55 Autoride Susp. or Premium Smooth Ride Susp.) ALL 4 Door (New Style) w/ Premium Smooth Ride Susp. (Exc. Z55 Autoride Susp.) ALL 4 Door (Old Style) (Incl. Denali)		344381 341343 344266	344384 SR2003	KG54327 KG5040	KG54341	565067	565103			
1995-99	ALL 4 Door (Incl. Denali)		344266	344262	KG5480	KG54101	565062	565034			
1992-99	ALL 2 Door (Incl. Z-71 Off Road Package)		344266	344263	KG5480	KG5479	565062	565061			

Notes de bas de Page 320 - Guia de notas al calce del catalogo Pg. 321  
 Bold part numbers indicate the most comparable KYB product to the original design & performance.  
 (22) For vehicles with Electronic Susp., Leveling Control, and Air Suspensions refer to Appendix C.

# Applications For Pass. Cars, Light Trucks, SUV's, & Vans

VEHICLE MAKE, MODEL & YEAR	  	STRUT & SHOCK		BOOT KITS	
MARQUE, MODELE ET		MOUNTS			
ANNEE DU VEHICULE					
LA MARCA EL MODELO & AÑO					
	 	 	 	 	 

## GMC Yukon (4WD) Steering Stabilizer

1993-05	Complete Unit	SS15326								
---------	---------------	---------	--	--	--	--	--	--	--	--

## GMC Yukon (4WD) Lift Replacement Shocks

2001-06	Yukon (Exc. Z55 Autoride Susp., Denali or Premium Smooth Ride Susp.) Lift = 1-3"					565076				
1992-99	ALL 2 Door (Incl. Z-71 Off Road Package) Lift = 0-3" for Edelbrock # 6360 Lift = 4-6" for Rancho # RS5244 Lift = 4-6" for Rancho # RS9244 Lift = 4-6" for Rancho # RSX17316 Lift = 4-6" for Edelbrock # 63003 Lift = 4-6" for Edelbrock # 6460 Lift = 4-6" for Rancho # RS5227 Lift = 4-6" for Rancho # RS9227 Lift = 4-6" for Rancho # RSX17315 Lift = 4-6"					565073 565086 565092 565092 565086	565074 565087 565087 565087 565087			

## GMC Yukon XL 1500 (1/2 Ton) (2WD)

2007-09	ALL (Exc. Electronic & Premium Smooth Ride Susp.)	341493	345073	551121	555054			SM5530		
2000-06	ALL (Exc. Z55 Autoride Susp. or ZW7 Premium Smooth Ride Susp.) ALL w/ ZW7 Premium Smooth Ride Susp. (Exc. Z55 Autoride Susp.)	344381 341343	344384 SR2004	KG54327 KG5040	KG54341	565067	565103			

## GMC Yukon XL 1500 (1/2 Ton) (4WD)

2007-09	ALL (Exc. Electronic & Premium Smooth Ride Susp.)	341493	345073	551121	555054			SM5530		
2000-06	ALL (Exc. Z55 Autoride Susp. or ZW7 Premium Smooth Ride Susp.) ALL w/ ZW7 Premium Smooth Ride Susp. (Exc. Z55 Autoride Susp.)	344381 341343	344384 SR2004	KG54327 KG5040	KG54341	565067	565103			

## GMC Yukon XL 2500 (3/4 Ton) (2WD)

2001-09	ALL w/ Torsion Bar Front Susp. (Exc. Z55 Autoride & QuadraSteer)	344383	344384	KG54340	KG54341	565102	565103			
2000-01	ALL w/ Coil Spring Front Susp. (Exc. Z55 Autoride)	344402	344384	KG54339	KG54341	565101	565103			

## GMC Yukon XL 2500 (3/4 Ton) (4WD)

2000-09	ALL (Exc. Z55 Autoride Susp. or QuadraSteer)	344383	344385	KG54340	KG54341	565102	565103			
---------	--	--------	--------	---------	---------	--------	--------	--	--	--

## GMC Yukon XL (4WD) Steering Stabilizer

2000-05	Complete Unit	SS15326								
---------	---------------	---------	--	--	--	--	--	--	--	--

## HONDA Accord (also see STRUT-PLUS)

2008-10	ALL							SM5058	SM5058	SB108	SB108
2007	ALL (Exc. Hybrid) Strut Boot - ALL w/ 2.4L Eng. Strut Boot - Sedan w/ 3.0L Eng.	341330	341331					SM5058	SM5058	SB108	SB108 SB107
2006-10	Control Arm Bushing (Strut to Arm)							SM5207			
2005-07	Hybrid	341330	341369					SM5058	SM5058	SB108	
2005-06	ALL (Exc. Hybrid)	341330	341331					SM5058	SM5058	SB108	SB108

Notes de bas de Page 320 - Guia de notas al calce del catalogo Pg. 321  
 Bold part numbers indicate the most comparable KYB product to the original design & performance.  
 (22) For vehicles with Electronic Susp., Leveling Control, and Air Suspensions refer to Appendix C.

# Applications For Pass. Cars, Light Trucks, SUV's, & Vans

VEHICLE MAKE, MODEL & YEAR	<i><b>GR-2</b></i>	<i><b>Gas-a-Just</b></i>	<i><b>MonoMax</b></i> 56XXXX Series	STRUT & SHOCK	BOOT KITS
MARQUE, MODELE ET ANNEE DU VEHICULE	<i><b>Excel-G</b></i>		<i><b>AGX</b></i> 7XXXX Series	MOUNTS	
LA MARCA EL MODELO & AÑO					

## HONDA Accord (also see STRUT-PLUS) (continued)

2005	Control Arm Bushing (Strut to Arm)							SM5207			
2003-04	ALL Control Arm Bushing (Strut to Arm)	341330	341331					SM5058 SM5207	SM5058	SB108	SB108
1998-02	ALL Control Arm Bushing (Strut to Arm)	341257	341258			741049	741050	SM5058 SM5207	SM5058	SB108	SB107
1994-97	ALL (Incl. Station Wagon) Right Hand Left Hand Mount Plate w/ Insulator Control Arm Bushing (Strut to Arm) Knuckle Shock Bushing Upper Spring Seat Insulator Lower Spring Seat Insulator	341497 341498	341490 341490			741010 741011	741012 741012	SM5058 SM5058 SM5514 SM5207  SM5486	SM5059 SM5059 SM5515  SM5051 SM5525 SM5526	SB108 SB108	SB107 SB107
1990-93	ALL (Incl. Station Wagon) Right Hand Left Hand Mount Plate w/ Insulator Control Arm Bushing (Strut to Arm) Knuckle Shock Bushing Upper Spring Seat Insulator Lower Spring Seat Insulator	341117 341118	341119 341119			741010 741011	741012 741012	SM5058 SM5058 SM5514 SM5207  SM5486	SM5059 SM5059 SM5515  SM5051 SM5525 SM5526	SB108 SB108	SB107 SB107
1986-89	ALL Right Hand Left Hand Control Arm Bushing (Strut to Arm) Knuckle Shock Bushing	341072 341073	341074 341074					SM5058 SM5058 SM5209  SM5051	SM5059 SM5059   SM5051	SB108 SB108	SB108 SB108
1984-85	ALL Right Hand Left Hand	233019 233020	233021 233021					SM5292 SM5292	SM5059 SM5059	SB103 SB103	SB103 SB103
1982-83	ALL Right Hand Left Hand	233017 233018	233021 233021					SM5292 SM5292	SM5059 SM5059	SB103 SB103	SB103 SB103
1979-81	ALL Right Hand Left Hand	233009 233010	233011 233012					SM5059 SM5059	SM5059 SM5059	SB103 SB103	SB103 SB103
1976-78	ALL Right Hand Left Hand	233009 233010						SM5059 SM5059	SM5059 SM5059	SB103 SB103	SB103 SB103

## HONDA Accord - STRUT-PLUS

1994-97	ALL Right Hand Left Hand	SR4047 <sup>70</sup> SR4048 <sup>70</sup>	SR4049 <sup>70</sup> SR4050 <sup>70</sup>								
1990-93	ALL Right Hand Left Hand	SR4043 SR4044	SR4045 SR4046								

## HONDA Civic (also see STRUT-PLUS)













2006-10	Sedan (Exc. Si Model) Right Hand Left Hand Strut / Shock Boot	339035 339036	343460 343460								SB101
2003-05	ALL (Exc. Hybrid) Right Hand Left Hand Hybrid Right Hand Left Hand Hatchback Sedan & Coupe	331010 331011 331008 331009	341362 341362 341362 341362					SM5403 SM5402	SM5401 SM5400	SB103 SB103 SB103 SB103	SB108 SB108 SB108 SB108
2002	ALL (Exc. Si Model) Right Hand Left Hand Si Model Right Hand Left Hand	331008 331009 331010 331011	341311 341311 341311 341311			731003 731004	741060 741060 741060 741060	SM5402 SM5402 SM5403 SM5403	SM5400 SM5400 SM5401 SM5401	SB103 SB103 SB103 SB103	SB108 SB108 SB108 SB108
2001	ALL (Exc. Si Model) Right Hand Left Hand	331008 331009	341311 341311			731003 731004	741060 741060	SM5403 SM5403	SM5400 SM5400	SB103 SB103	SB108 SB108
1996-00	ALL Mount Plate w/ Insulator	341203	341198			741023	741024	SM5058 SM5538	SM5058 SM5516	SB108	SB108

<sup>70</sup> New Part Number, Available 2nd Quarter 2011

Notes de bas de Page 320 - Guia de notas al calce del catalogo Pg. 321

Bold part numbers indicate the most comparable KYB product to the original design & performance.  
(22) For vehicles with Electronic Susp., Leveling Control, and Air Suspensions refer to Appendix C.

# Applications For Pass. Cars, Light Trucks, SUV's, & Vans

VEHICLE MAKE, MODEL & YEAR	  	STRUT & SHOCK		BOOT KITS	
MARQUE, MODELE ET		MOUNTS			
ANNEE DU VEHICULE					
LA MARCA EL MODELO & AÑO					
	 	 	 	 	 

## HONDA Civic (also see STRUT-PLUS) (continued)

1996-00	Control Arm Bushing (Strut to Arm)							SM5210	SM5208			
	Upper Spring Seat Insulator							SM5527	SM5528			
1992-95	ALL	Right Hand	341138	341094			741005	741007	SM5058	SM5058	SB108	SB108
		Left Hand	341139	341094			741006	741007	SM5058	SM5058	SB108	SB108
	Mount Plate w/ Insulator								SM5538	SM5516		
	Control Arm Bushing (Strut to Arm)								SM5210			
	Upper Spring Seat Insulator								SM5527	SM5166		
									SM5528			
1989-91	ALL (Exc. Station Wagon)	Right Hand	341135	341094			741008	741007	SM5058	SM5058	SB108	SB108
		Left Hand	341136	341094			741009	741007	SM5058	SM5058	SB108	SB108
	Control Arm Bushing (Strut to Arm)								SM5166			
1988	ALL (Exc. Station Wagon)	Right Hand	341135	340008 <sup>2</sup>			741008		SM5058	SM5058	SB108	
		Left Hand	341136	340008 <sup>2</sup>			741009		SM5058	SM5058	SB108	
	Knuckle Shock Bushing								SM5051			
1984-87	ALL (Exc. Station Wagon)	Right Hand	234010	341050 <sup>2</sup>					SM5293	SM5059	SB103	
		Left Hand	234011	341050 <sup>2</sup>					SM5293	SM5059	SB103	
	S/W - 2WD (Includes WagoVan)											
		Right Hand	234020	340001 <sup>2</sup>					SM5293	SM5059	SB103	
		Left Hand	234021	340001 <sup>2</sup>					SM5293	SM5059	SB103	
1980-83	1300,1500 CVCC (Exc. Station Wagon)	Right Hand		231011						SM5059	SB103	SB103
		Left Hand		231012						SM5059	SB103	SB103
	1500 CVCC Station Wagon			343030			KG4006				SB103	
1976-79	1500 CVCC Station Wagon			343030			KG4006				SB103	
1975	1200 Station Wagon w/ Sealed Strut			343030			KG4006				SB103	
	1500 CVCC Station Wagon w/ Sealed Strut			343030			KG4006				SB103	

## HONDA Civic - STRUT-PLUS

1996-00	ALL	Right Hand	SR4040 <sup>70</sup>	SR4042 <sup>70</sup>								
		Left Hand	SR4041 <sup>70</sup>	SR4042 <sup>70</sup>								

## HONDA CR-V

2007-10	ALL			341492						SM5400	SB102	SB108	
2005-06	ALL	Right Hand	331037	341463						SM5403	SM5400	SB104	SB108
		Left Hand	331038	341463						SM5403	SM5400	SB104	SB108
2002-04	ALL	Right Hand	331035	341488						SM5403	SM5400	SB104	SB108
		Left Hand	331036	341488						SM5403	SM5400	SB104	SB108
1997-01	ALL		341260	341261						SM5058	SM5058	SB108	SB108
	Mount Plate w/ Insulator									SM5538	SM5516		
	Upper Spring Seat Insulator									SM5527	SM5528		

## HONDA CRX

1989-91	ALL	Right Hand	341135	341094			741008	741007	SM5058	SM5058	SB108	SB108
		Left Hand	341136	341094			741009	741007	SM5058	SM5058	SB108	SB108
	Control Arm Bushing (Strut to Arm)									SM5166		
1988	ALL	Right Hand	341135	340008 <sup>2</sup>			741008		SM5058	SM5058	SB108	
		Left Hand	341136	340008 <sup>2</sup>			741009		SM5058	SM5058	SB108	
1984-87	ALL	Right Hand	234010	341050 <sup>2</sup>					SM5293	SM5059	SB103	
		Left Hand	234011	341050 <sup>2</sup>					SM5293	SM5059	SB103	

<sup>2</sup> The KYB replacement unit comes with a new dustcover/ bumper assembly.

<sup>70</sup> New Part Number, Available 2nd Quarter 2011

# Applications For Pass. Cars, Light Trucks, SUV's, & Vans

VEHICLE MAKE, MODEL & YEAR												
MARQUE, MODELE ET	<b>GR-2</b>	<b>Gas-a-Just</b>	<b>MonoMax</b> 56XXXX Series	STRUT & SHOCK								
ANNEE DU VEHICULE	<b>Excel-G</b>		<b>AGX</b> 7XXXXX Series	MOUNTS						BOOT KITS		
LA MARCA EL MODELO & AÑO												

## HONDA Del Sol

1993-97	ALL	Right Hand	341138	341094			741005	741007	SM5058	SM5058	SB108	SB108
		Left Hand	341139	341094			741006	741007	SM5058	SM5058	SB108	SB108
	Control Arm Bushing (Strut to Arm)								SM5210			
	Mount Plate w/ Insulator								SM5538	SM5166		
	Upper Spring Seat Insulator								SM5527	SM5528		

## HONDA Element

2007-10	EX & LX Models	Right Hand		344611					SM5403	SM5400	SB104	SB108
		Left Hand		344611					SM5403	SM5400	SB104	SB108
2003-06	ALL	Right Hand	331039	344611					SM5403	SM5400	SB104	SB108
		Left Hand	331040	344611					SM5403	SM5400	SB104	SB108

## HONDA Fit

2009-10	ALL	Right Hand	338001	348016 <sup>70</sup>								
		Left Hand	338002	348016 <sup>70</sup>								
2007-08	ALL	Right Hand	333474	343487								
		Left Hand	333475	343487								

## HONDA Insight

2000-06	Strut / Shock Boot										SB102	
---------	--------------------	--	--	--	--	--	--	--	--	--	-------	--

## HONDA Odyssey

2005-08	ALL			349091 <sup>70</sup>					SM5537		SB105	
1999-04	ALL	Right Hand	334317	344353					SM5211		SB105	
		Left Hand	334318	344353					SM5211		SB105	
1995-98	ALL	Right Hand	341200	344274					SM5058	SM5058	SB108	SB107
		Left Hand	341201	344274					SM5058	SM5058	SB108	SB107
	Control Arm Bushing (Strut to Arm)								SM5207			
	Lower Shock Bushing									SM5224		
	Mount Plate w/ Insulator								SM5514			
	Upper Spring Seat Insulator								SM5486			

## HONDA Passport

1998-02	ALL		344298	344299	KG54337	KG54338						
1994-97	ALL		344430		KG5476	KG5534						

## HONDA Pilot

2003-08	ALL	Right Hand	334364	344353					SM5211		SB104	
		Left Hand	334365	344353					SM5211		SB104	

## HONDA Prelude

1997-01	ALL (Exc. Type SH)	Right Hand	341177	341179			741030	741032	SM5058	SM5059	SB108	SB108
		Left Hand	341178	341179			741031	741032	SM5058	SM5059	SB108	SB108
	Control Arm Bushing (Strut to Arm)								SM5207	SM5209		
	Upper Spring Seat Insulator								SM5486	SM5360		
1992-96	ALL	Right Hand	341177	341179			741030	741032	SM5058	SM5059	SB108	SB108
		Left Hand	341178	341179			741031	741032	SM5058	SM5059	SB108	SB108
	Control Arm Bushing (Strut to Arm)								SM5207			
	Upper Spring Seat Insulator								SM5486	SM5360		
1988-91	ALL	Right Hand	341072						SM5058	SM5291	SB108	
		Left Hand	341073						SM5058	SM5291	SB108	
	Control Arm Bushing (Strut to Arm)								SM5209	SM5209		

<sup>70</sup> New Part Number, Available 2nd Quarter 2011

Notes de bas de Page 320 - Guia de notas al calce del catalogo Pg. 321  
 Bold part numbers indicate the most comparable KYB product to the original design & performance.  
 (22) For vehicles with Electronic Susp., Leveling Control, and Air Suspensions refer to Appendix C.

# Applications For Pass. Cars, Light Trucks, SUV's, & Vans

VEHICLE MAKE, MODEL & YEAR		<b>GR-2</b>		<b>Gas-a-Just</b>		<b>MonoMax</b> 56XXXX Series		STRUT & SHOCK			
MARQUE, MODELE ET		<b>Excel-G</b>				<b>AGX</b> 7XXXXX Series		MOUNTS		BOOT KITS	
ANNEE DU VEHICULE											
LA MARCA EL MODELO & AÑO											

## HONDA Prelude (continued)

1984-87	ALL	Right Hand Left Hand	340002 <sup>2</sup> 340002 <sup>2</sup>	234022 234023					SM5058 SM5058	SM5059 SM5059		SB103 SB103
1983	ALL		340002 <sup>2</sup>	233021					SM5058	SM5059		SB103
1979-82	ALL		363058							SM5059		SB103

## HONDA Ridgeline

2009-10	ALL	Right Hand Left Hand	339039 339040							SM5400 SM5400	SB105 SB105	SB107 SB107
2006-08	ALL	Right Hand Left Hand	339039 339040	341402 341402						SM5400 SM5400	SB105 SB105	SB107 SB107

## HONDA S2000

2000-09	ALL	Mount Plate w/ Insulator Upper Spring Seat Insulator							SM5401 SM5538 SM5527	SM5401 SM5538	SB108	SB108
---------	-----	---	--	--	--	--	--	--	----------------------------	------------------	-------	-------

## HUMMER H2

2003-07	ALL				KG5782	KG5194	565102	565095				
---------	-----	--	--	--	--------	--------	--------	--------	--	--	--	--

## HUMMER H3

2006-08	ALL				555049	555050						
---------	-----	--	--	--	--------	--------	--	--	--	--	--	--

## HYUNDAI Accent

2006-10	ALL (Exc. SE)	Right Hand Left Hand	333516 333517	348002 348002								
	Strut / Shock Boot										SB102	SB107
2003-05	ALL	Right Hand Left Hand	333497 333498	332135 332136								
2000-02	ALL	Right Hand Left Hand	333304 333305	332108 332109					SM5201 SM5201		SB103 SB103	SB110 SB110
5/97-99	ALL	Right Hand Left Hand	333211 333212	332094 332095					SM5149 SM5149	SM5148 SM5148	SB101 SB101	SB103 SB103
1995-4/97	ALL	Right Hand Left Hand	333211 333212	332080 332081					SM5149 SM5149	SM5148 SM5148	SB101 SB101	SB103 SB103

## HYUNDAI Azera

2009-10	Strut Boot										SB103	SB102
2006-08	ALL		341476	349060							SB101	SB102











## HYUNDAI Elantra

2009-10	ALL (Exc. Touring Series and Sport Susp.) Sedan Station Wagon			349085								SB101 SB102
2007-08	ALL	Right Hand Left Hand	338003 <sup>70</sup> 338004 <sup>70</sup>	349085 349085							SB101 SB101	SB101 SB101
7/00-06	ALL	Right Hand Left Hand	333205 333206	333500 333501			733020 733021		SM5193 SM5193	SM5240 SM5239	SB101 SB101	SB103 SB103
1996-6/00	ALL	Right Hand Left Hand	333205 333206	333207 333208			733020 733021	733022 733023	SM5193 SM5193	SM5240 SM5239	SB101 SB101	SB103 SB103
1992-95	ALL		235033	341084					SM5063	SM5091	SB101	SB103

<sup>2</sup> The KYB replacement unit comes with a new dustcover/ bumper assembly.

<sup>70</sup> New Part Number, Available 2nd Quarter 2011

# Applications For Pass. Cars, Light Trucks, SUV's, & Vans

VEHICLE MAKE, MODEL & YEAR		<b>GR-2</b>		<b>Gas-a-Just</b>		<b>MonoMax</b> 56XXXX Series		STRUT & SHOCK			
MARQUE, MODELE ET		<b>Excel-G</b>				<b>AGX</b> 7XXXXX Series		MOUNTS		BOOT KITS	
ANNEE DU VEHICULE											
LA MARCA EL MODELO & AÑO		 		 		 		 		 	

## HYUNDAI Entourage

2007-08	ALL		349094					SM5539		SB105	
---------	-----	--	--------	--	--	--	--	--------	--	-------	--

## HYUNDAI Excel

1990-94	ALL	234043			KG4192			SM5060		SB116	
1989	ALL	365074			KG4192			SM5032		SB103	
1986-88	ALL	365027			KG4192			SM5032		SB103	

## HYUNDAI Pony (Canadian Vehicle)

1984-87	ALL		343030		KG4006					SB103	
---------	-----	--	--------	--	--------	--	--	--	--	-------	--

## HYUNDAI Santa Fe

2010	Strut / Shock Boot									SB105	
2007-10	Strut Mount & Bearing							SM5539			
2007-09	ALL	Right Hand	334506	344500						SB105	
		Left Hand	334507	344500						SB105	
2001-06	ALL	Right Hand	334500	344314				SM5295	SM5296		
		Left Hand	334501	344314				SM5295	SM5296	SB102	SB108
		Strut Boot w/ 3.5L Eng.								SB105	SB108
		Strut Boot w/o 3.5 L Eng.									SB108

## HYUNDAI Scoupe

1991-95	ALL	234043			KG4192			SM5060		SB116	
---------	-----	--------	--	--	--------	--	--	--------	--	-------	--

## HYUNDAI Sonata

2009-10	ALL	340024 <sup>70</sup>	349102 <sup>70</sup>								
2009	Strut / Shock Boot									SB103	
2006-08	2.4L 3.3L		340022	349060						SB101	SB102
			341476	349060						SB101	SB102
10/04-05	ALL	341477	341478								
4/00-10/04	ALL	341280	341281					SM5091	SM5091	SB101	SB101
1999-3/00	ALL	341245	341246					SM5091	SM5200	SB101	SB101
1995-98	ALL	334141	341192					SM5194	SM5294	SB101	SB101
1989-94	ALL (Exc. ABS)	235027			KG9011			SM5195	SM5294	SB101	

## HYUNDAI Tiburon

2003-08	ALL	Right Hand	333508	333510					SM5240	SB103	SB101	
		Left Hand	333509	333511					SM5239	SB103	SB101	
1997-01	ALL	Right Hand	333205	333207			733020	733022	SM5193	SM5240	SB103	SB101
		Left Hand	333206	333208			733021	733023	SM5193	SM5239	SB103	SB101

## HYUNDAI Tucson

2005-10	ALL	Right Hand	334502	334504					SM5295	SM5240	SB105	SB105
		Left Hand	334503	334505					SM5295	SM5240	SB105	SB105











## HYUNDAI Veracruz

2007-09	Strut Boot Strut Mount & Bearing							SM5539		SB102	
---------	-------------------------------------	--	--	--	--	--	--	--------	--	-------	--

<sup>70</sup> New Part Number, Available 2nd Quarter 2011

Notes de bas de Page 320 - Guia de notas al calce del catalogo Pg. 321  
 Bold part numbers indicate the most comparable KYB product to the original design & performance.  
 (22) For vehicles with Electronic Susp., Leveling Control, and Air Suspensions refer to Appendix C.

# Applications For Pass. Cars, Light Trucks, SUV's, & Vans

VEHICLE MAKE, MODEL & YEAR		<b>GR-2</b> <i>Excel-G</i>		<b>Gas-a-Just</b>		<b>MonoMax</b> 56XXXX Series <b>AGX</b> 7XXXX Series		STRUT & SHOCK MOUNTS		BOOT KITS	
MARQUE, MODELE ET ANNEE DU VEHICULE		 		 		 		 		 	
LA MARCA EL MODELO & AÑO											

## HYUNDAI XG300, XG350

2001-05	ALL		341280	341281					SM5091	SM5091	SB101	SB101
---------	-----	--	--------	--------	--	--	--	--	--------	--------	-------	-------

## INFINITI FX35

2003-08	ALL	Right Hand	339055	349027							SB105	SB103
		Left Hand	339056	349027							SB105	SB103

## INFINITI FX45

2003-08	ALL	Right Hand	339055	349027							SB105	SB103
		Left Hand	339056	349027							SB105	SB103

## INFINITI G20

1999-02	ALL		341120	341194			741029	741021	SM5123	SM5123	SB101	SB108
1991-96	ALL	Right Hand	341120	235061			741029	734008	SM5123	SM5204	SB101	SB101
		Left Hand	341120	235062			741029	734009	SM5123	SM5204	SB101	SB101

## INFINITI G35 (AWD)

2007-08	ALL w/o 4 Wheel Steering	Right Hand	340010	349089								
		Left Hand	340011	349089								
2005-06	ALL	Right Hand	341379	344492						SM5482	SB103	SB108
		Left Hand	341380	344492						SM5482	SB103	SB108
2004	Upper Spring Seat Insulator								SM5560			

## INFINITI G35 (RWD)

2007-08	Sedan w/o 4 Wheel Steering	Right Hand	340020	349096								
		Left Hand	340021	349096								
2007	Coupe Strut Mount w/ Insulator (Coupe) Upper Spring Seat Insulator (Coupe)								SM5542 <sup>70</sup> SM5560		SB101	
2005-06	Coupe w/ Sport Susp. Upper Spring Seat Insulator	Right Hand	341366	344455					SM5542 <sup>70</sup>	SM5482	SB101	
		Left Hand	341367	344455					SM5542 <sup>70</sup> SM5560	SM5482	SB101	
2003-06	Coupe (Exc. Sport Susp.)	Right Hand	341377	344491					SM5542 <sup>70</sup>	SM5482	SB101	SB108
		Left Hand	341378	344491					SM5542 <sup>70</sup>	SM5482	SB101	SB108
	Sedan	Right Hand	341377	344491					SM5542 <sup>70</sup>	SM5482	SB101	SB108
		Left Hand	341378	344491					SM5542 <sup>70</sup> SM5560	SM5482	SB101	SB108
2003-04	Coupe w/ Sport Susp. Upper Spring Seat Insulator	Right Hand	341366	344455					SM5542 <sup>70</sup>	SM5482	SB101	SB108
		Left Hand	341367	344455					SM5542 <sup>70</sup> SM5560	SM5482	SB101	SB108

## INFINITI G37 (AWD)

2009-10	Sedan w/o 4 Wheel Steering	Right Hand	340010	349089								
		Left Hand	340011	349089								
	Coupe w/o 4 Wheel Steering			349089								

## INFINITI G37 (RWD)











2009-10	Convertible											SB108
2008-10	Sedan w/o 4 Wheel Steering	Right Hand	340020	349096								
		Left Hand	340021	349096								
	Coupe w/o 4 Wheel Steering			349096								

<sup>70</sup> New Part Number, Available 2nd Quarter 2011

Notes de bas de Page 320 - Guia de notas al calce del catalogo Pg. 321  
 Bold part numbers indicate the most comparable KYB product to the original design & performance.  
 (22) For vehicles with Electronic Susp., Leveling Control, and Air Suspensions refer to Appendix C.



# Applications For Pass. Cars, Light Trucks, SUV's, & Vans

VEHICLE MAKE, MODEL & YEAR		  	STRUT & SHOCK		BOOT KITS						
MARQUE, MODELE ET			MOUNTS								
ANNEE DU VEHICULE											
LA MARCA EL MODELO & AÑO											
											

## INFINITI I30

2000-01	ALL	Right Hand Left Hand	334265 334266	341271 341271					SM5409 SM5409	SM5217 SM5217	SB104 SB104	SB108 SB108
1996-99	ALL	Right Hand Left Hand	334150 334151	341202 341202			734017 734018	741039 741039	SM5324 SM5324 SM5122 SM5323	SM5123 SM5123	SB104 SB104	SB108 SB108
	Strut Mount w/ Bearing Strut Mount Bearing											

## INFINITI I35

2002-04	ALL (Exc. Sport Susp.)	Right Hand Left Hand	334366 334367	341341 341341					SM5409 SM5409	SM5217 SM5217	SB104 SB104	SB108 SB108
---------	------------------------	-------------------------	------------------	------------------	--	--	--	--	------------------	------------------	----------------	----------------

## INFINITI M35

2008	RWD (Exc. Sport Susp.)	Right Hand Left Hand		349053 349053						SM5482 SM5482		
2006-07	RWD (Exc. Sport Susp.)	Right Hand Left Hand	341441 341442	349053 349053						SM5482 SM5482		

## INFINITI M45

2008	ALL (Exc. Sport Susp.)	Right Hand Left Hand		349053 349053						SM5482 SM5482		
2006-07	ALL (Exc. Sport Susp.)	Right Hand Left Hand	341441 341442	349053 349053						SM5482 SM5482		

## INFINITI Q45 (Standard susp. only)

1997-01	Sturt Mounting Kit (Exc. Touring)								SM5328	SM5123	SB101	SB101
1990-96	ALL w/o Active Susp.								SM5324	SM5123	SB101	

## INFINITI QX4 (2WD)

2002-03	ALL	Right Hand Left Hand	335035 335036	343379 343379		KG4163 KG4163			SM5203 SM5203		SB129 SB129	
2001-03	Strut Mount, Bearing & Boot kit Strut Mount Bearing								SM5329 SM5323			
2001	ALL	Right Hand Left Hand	335030 335031	343379 343379		KG4163 KG4163			SM5203 SM5203		SB129 SB129	

## INFINITI QX4 (4WD)

2002-03	ALL	Right Hand Left Hand	335032 335033	343379 343379		KG4163 KG4163			SM5203 SM5203		SB129 SB129	
12/98-01	ALL	Right Hand Left Hand	335030 335031	343379 343379		KG4163 KG4163			SM5203 SM5203		SB129 SB129	
1997-03	Strut Mount, Bearing & Boot kit Strut Mount Bearing								SM5329 SM5323			
1997-11/98	ALL	Right Hand Left Hand	335015 335016	343388 343388		KG54318 KG54318			SM5203 SM5203		SB129 SB129	

## INFINITI QX56











2004-07	ALL (Exc. Auto Rear Leveling)		341600	NA								
---------	-------------------------------	--	--------	----	--	--	--	--	--	--	--	--

## INTERNATIONAL Scout, Scout II (Incl. Traveler and Terra)

1971-80	ALL		344071	344085	KG5414	KG5419						
---------	-----	--	--------	--------	--------	--------	--	--	--	--	--	--

Notes de bas de Page 320 - Guia de notas al calce del catalogo Pg. 321  
 Bold part numbers indicate the most comparable KYB product to the original design & performance.  
 (2) For vehicles with Electronic Susp., Leveling Control, and Air Suspensions refer to Appendix C.

# Applications For Pass. Cars, Light Trucks, SUV's, & Vans

VEHICLE MAKE, MODEL & YEAR	<b>GR-2</b>	<b>Gas-a-Just</b>	<b>MonoMax</b> 56XXXX Series	STRUT & SHOCK			
MARQUE, MODELE ET	<b>Excel-G</b>		<b>AGX</b> 7XXXX Series	MOUNTS		BOOT KITS	
ANNEE DU VEHICULE	 	 	 	 	 		
LA MARCA EL MODELO & AÑO							

## ISUZU Amigo

1998-00	ALL	344298	344299	KG54337	KG54338						
1989-95	ALL	344430	344090	KG5476	KG5466						

## ISUZU Ascender

2003-08	ALL Strut Boot Mount w/ Spring Insulator Lower Spring Seat Insulator	331043 <sup>81</sup>	343395		KG4162				SM5395 SM5548		SB108	
---------	---	----------------------	--------	--	--------	--	--	--	------------------	--	-------	--

## ISUZU Axiom

2002-04	ALL (Exc. Electronic Susp.)	344298	344299	KG54337	KG54338							
---------	-----------------------------	--------	--------	---------	---------	--	--	--	--	--	--	--

## ISUZU Hombre (2WD)

1996-00	ALL ALL (Lowered 2" / 4")	344040	344041	KG5450	KG5451	565046 565046	565047 565064					
---------	------------------------------	--------	--------	--------	--------	------------------	------------------	--	--	--	--	--

## ISUZU Hombre (4WD)

1996-00	ALL	344042	344041	KG5452	KG5451	565048	565047					
---------	-----	--------	--------	--------	--------	--------	--------	--	--	--	--	--

## ISUZU I-280

2006	RWD	341374	344464		KG5191							
------	-----	--------	--------	--	--------	--	--	--	--	--	--	--

## ISUZU I-290

2007	RWD	341374	344464		KG5191							
------	-----	--------	--------	--	--------	--	--	--	--	--	--	--

## ISUZU I-350

2006	4WD	344465	344466	KG5781	KG5190							
------	-----	--------	--------	--------	--------	--	--	--	--	--	--	--

## ISUZU I-370

2007	ALL	344465	344466	KG5781	KG5190							
------	-----	--------	--------	--------	--------	--	--	--	--	--	--	--

## ISUZU I-Mark

1985-91	ALL (Exc. Lotus Susp.)	Right Hand	232015		KG4542			SM5297		SB102	
		Left Hand	232016		KG4542			SM5297		SB102	
	ALL w/ Lotus Susp.	Right Hand	232015					SM5297		SB102	
		Left Hand	232016					SM5297		SB102	
1981-84	ALL			KG4773A	KG4772A						

## ISUZU Impulse

1990-92	ALL FWD (Exc. Lotus Susp.)	Right Hand	234041	232033				SM5081	SM5105	SB102	SB105
		Left Hand	234042	232034				SM5081	SM5105	SB102	SB105
	AWD	Right Hand	234041					SM5081	SM5105	SB102	SB101
		Left Hand	234042					SM5081	SM5105	SB102	SB101
	FWD w/ Lotus Susp.	Right Hand	234041	332076				SM5081	SM5105	SB102	SB101
		Left Hand	234042	332077				SM5081	SM5105	SB102	SB101
1983-89	ALL (Exc. RS Model)		343039	KG4773A	KG5552						







## ISUZU Oasis Van

1995-99	ALL	Right Hand	341200	344274				SM5058	SM5058	SB108	SB107
		Left Hand	341201	344274				SM5058	SM5058	SB108	SB107
	Control Arm Bushing (Strut to Arm)							SM5207			
	Lower Shock Bushing								SM5224		
	Mount Plate w/ Insulator							SM5514			

<sup>81</sup> Replaces [331016], when stock is depleted

Notes de bas de Page 320 - Guia de notas al calce del catalogo Pg. 321  
 Bold part numbers indicate the most comparable KYB product to the original design & performance.  
 (22) For vehicles with Electronic Susp., Leveling Control, and Air Suspensions refer to Appendix C.

# Applications For Pass. Cars, Light Trucks, SUV's, & Vans

VEHICLE MAKE, MODEL & YEAR	<b>GR-2</b>	<b>Gas-a-Just</b>	<b>MonoMax</b> 56XXXX Series	STRUT & SHOCK	
MARQUE, MODELE ET	<b>Excel-G</b>		<b>AGX</b> 7XXXXX Series	MOUNTS	BOOT KITS
ANNEE DU VEHICULE	 	 	 	 	 
LA MARCA EL MODELO & AÑO					

## ISUZU Oasis Van (continued)

1995-99	Upper Spring Seat Insulator							SM5486			
---------	-----------------------------	--	--	--	--	--	--	--------	--	--	--

## ISUZU Pickup (2WD)

1988-95	ALL	343208	344090	KG4605A	KG5466	565029					
8/86-87	ALL	343208	344015	KG4605A	KG4026						
1981-7/86	ALL		344015	KG4625C	KG4026						

## ISUZU Pickup (4WD)

1988-95	ALL	344098	344090	KG5476	KG5466						
1981-87	ALL		344015	KG4613A	KG4026						

## ISUZU Rodeo

1998-04	ALL (Exc. Active Susp.)	344298	344299	KG54337	KG54338						
1991-97	ALL	344430		KG5476	KG5534						

## ISUZU Stylus

1990-93	ALL (Exc. Lotus Susp.)	Right Hand	234041	232033					SM5081	SM5105	SB102	SB105
		Left Hand	234042	232034					SM5081	SM5105	SB102	SB105
	ALL w/ Lotus Susp.	Right Hand	234041	332076					SM5081	SM5105	SB102	SB105
		Left Hand	234042	332077					SM5081	SM5105	SB102	SB105

## ISUZU Trooper

1992-02	ALL			KG54304	KG54308	565022	565023				
1989-91	ALL	344430		KG5476	KG5534						
11/86-88	ALL			KG4613A	KG5534						
1981-10/86	ALL		344015	KG4613A	KG4026						

## ISUZU Trooper (4WD) - Steering Stabilizer

1984-91	Trooper II 4WD Complete Kit	SS15345									
---------	-----------------------------	---------	--	--	--	--	--	--	--	--	--

## ISUZU Vehicross

1999-01	ALL			KG54304	KG54308	565022	565023				
---------	-----	--	--	---------	---------	--------	--------	--	--	--	--

## JAGUAR S-Type

2000-08	Strut Mount w/ Insulator								SM5449	SM5449		
	Mount w/ Insulator & Boot w/ Insulator								SM5450	SM5450		
									SM5359	SM5359		
2000-05	ALL (Exc. Computer Active Technology Susp. (CATS))	551609 <sup>70</sup>	551610									

## JAGUAR Vanden Plas

1998-03	ALL (Exc. Adaptive Control Susp.)			KG5783	KG6796						SB101
---------	-----------------------------------	--	--	--------	--------	--	--	--	--	--	-------











## JAGUAR X-Type

2002-08	Strut / Shock Boot Spring Seat w/ Insulator									SM5357	SB101
---------	---	--	--	--	--	--	--	--	--	--------	-------

<sup>70</sup> New Part Number, Available 2nd Quarter 2011

Notes de bas de Page 320 - Guia de notas al calce del catalogo Pg. 321  
 Bold part numbers indicate the most comparable KYB product to the original design & performance.  
 (22) For vehicles with Electronic Susp., Leveling Control, and Air Suspensions refer to Appendix C.

# Applications For Pass. Cars, Light Trucks, SUV's, & Vans

VEHICLE MAKE, MODEL & YEAR	<i><b>GR-2</b></i>	<i><b>Gas-a-Just</b></i>	<i><b>MonoMax</b></i> 56XXXX Series	STRUT & SHOCK	
MARQUE, MODELE ET	<i><b>Excel-G</b></i>		<i><b>AGX</b></i> 7XXXXX Series	MOUNTS	BOOT KITS
ANNEE DU VEHICULE	 	 	 	 	 
LA MARCA EL MODELO & AÑO					

## JAGUAR XF

2009	Strut Mount w/ Insulator Mount w/ Insulator & Boot Spring Seat w/ Insulator							SM5449 SM5440 SM5359	SM5449 SM5450 SM5359		
------	---	--	--	--	--	--	--	----------------------------	----------------------------	--	--

## JAGUAR XJ8

1998-03	ALL (Exc. Adaptive Control Susp.) Strut / Shock Boot Spring Seat Insulator			KG5783	KG6796				SM5358	SB101	
---------	--	--	--	--------	--------	--	--	--	--------	-------	--

## JAGUAR XJR

1998-03	ALL (Exc. Adaptive Control Susp.)			KG5783	KG6796					SB101	
---------	-----------------------------------	--	--	--------	--------	--	--	--	--	-------	--

## JAGUAR XK8

1997-06	Coupe & Convertible									SB101	
1997-04	Spring Seat Insulator (XK Coupe & Convertible)								SM5358		
1997-02	ALL				KG6798						

## JAGUAR XKR

2000-06	Coupe & Convertible Spring Seat Insulator (XK Coupe & Convertible)								SM5358	SB101	
2000-02	ALL				KG6798						

## JAGUAR Vanden Plas

10/86-9/94	XJ6, Sovereign, VandenPlas (Exc. Self Leveling Rear Susp.) XJ6, Sovereign, VandenPlas w/ Self Leveling Rear Susp. (Conversion Kit)			KG9135	KG9309						
				KG9135	KG9309 <sup>26</sup>						
					KIT109 <sup>26</sup>						

## JAGUAR XJ6, XJ12, XJS, Sovereign, Vandenplas, MK II

1998-03	Spring Seat Insulator (XJR, Vanden Plas)								SM5358		
1995-97	Spring Seat Insulator (XJ6, XJ12, XJR, Vanden Plas)								SM5358		
12/94-97	XJ6, XJ12			KG4730	KG6797						
1987-95	XJ-S Model (4 Units Required on Rear)			KG4540	KG9122 <sup>2</sup>						
10/86-9/94	XJ6, Sovereign, VandenPlas (Exc. Self Leveling Rear Susp.) XJ6, Sovereign, VandenPlas w/ Self Leveling Rear Susp. (Conversion Kit)			KG9135	KG9309						
				KG9135	KG9309 <sup>26</sup>						
					KIT109 <sup>26</sup>						
1968-87	XJ6, XJ12, XJS (4 Units Required on Rear)			KG4540	KG9122 <sup>2</sup>						
1962-66	MK II Series Pass.Car		343219		KG5517						

## JEEP CJ Series

1982-86	CJ5, CJ7	344087	344085	KG5426	KG5419		565037				
1972-81	CJ5, CJ6 & CJ7	344426	344085	KG5401	KG5419		565037				
1964-68	CJ5A, CJ6A (Exc. w/ 5 Leaf Front Spring)	344426	344085	KG5401	KG5419		565037				
	CJ5A, CJ6A w/ 5 Leaf Front Spring	344426	344426	KG5401	KG5401						

<sup>2</sup> The KYB replacement unit comes with a new dustcover/ bumper assembly.

<sup>26</sup> Jaguar Rear Self-Leveling can be eliminated by using PN [KG9309] (2 req) and PN KIT109 (1. req) Worn-out self-leveling shocks may have fatigued rear springs. If necessary, Jaguar #JLM-11382 (from Jaguar) is required to restore proper ride height.

# Applications For Pass. Cars, Light Trucks, SUV's, & Vans

VEHICLE MAKE, MODEL & YEAR	<b>GR-2</b>		<b>Gas-a-Just</b>		<b>MonoMax</b> 56XXXX Series		STRUT & SHOCK			
MARQUE, MODELE ET	<b>Excel-G</b>				<b>AGX</b>		MOUNTS		BOOT KITS	
ANNEE DU VEHICULE					7XXXXX Series					
LA MARCA EL MODELO & AÑO										

## JEEP CJ Series (continued)

1955-71	CJ5, CJ6 (Exc. w/ 5 Leaf Front Spring)	344426	344085	KG5401	KG5419		565037				
	CJ5, CJ6 w/ 5 Leaf Front Springs	344426	344426	KG5401	KG5401						
1945-65	CJ2A, 3A, 3B Series	344426	344426	KG5401	KG5401						

## JEEP CJ - Steering Stabilizer

1976-86	OEM Replacement Cylinder	SS10316									
1942-86	Complete Kit	SS15345									

## JEEP Cherokee

1997-01	ALL (101" W.B.)	344088	344089	KG5464	KG5465	565053	565054				
1984-96	ALL (101" W.B.)	344088	344418	KG5464	KG5465	565053	565054				
1976-83	ALL	344087	344085	KG5426	KG5419		565037				
1974-75	ALL	344087		KG5426							

## JEEP Cherokee - Steering Stabilizer

1984-01	2WD & 4WD OEM Replacement Cylinder	SS10317									
	DANA #30 fits axles up to 2 3/4" diameter Complete Kit	SS15345									

## JEEP Comanche

1987-92	2WD	344088	344090	KG5464	KG5466	565053					
1986-92	4WD	344088	344090	KG5464	KG5466	565053					
1986	2WD	344088	344015	KG5464	KG4026	565053					

## JEEP Comanche - Steering Stabilizer

1986-92	Replacement Unit	SS10317									
---------	------------------	---------	--	--	--	--	--	--	--	--	--

## JEEP Commander

2010	ALL	341603									
2009	ALL	341603					SM5511				
2006-08	ALL	341603	344496				SM5511				

## JEEP Compass

2010	ALL	Right Hand	334642	341654							
		Left Hand	334643	341654							
2007-09	ALL	Right Hand	334642	341654					SB101	SB107	
		Left Hand	334643	341654					SB101	SB107	

## JEEP DJ Dispatcher











1965-74	DJ5, DJ6	344426	344085	KG5401	KG5419		565037				
1956-64	DJ3A	344426	344426	KG5401	KG5401						

## JEEP DJ5 - Steering Stabilizer

1976-85	DJ5-A Mail Truck - 1/4 Ton - OEM Replacement Cylinder	SS10316									
---------	---	---------	--	--	--	--	--	--	--	--	--

Notes de bas de Page 320 - Guia de notas al calce del catalogo Pg. 321  
 Bold part numbers indicate the most comparable KYB product to the original design & performance.  
 (22) For vehicles with Electronic Susp., Leveling Control, and Air Suspensions refer to Appendix C.

# Applications For Pass. Cars, Light Trucks, SUV's, & Vans

VEHICLE MAKE, MODEL & YEAR	<b>GR-2</b>	<b>Gas-a-Just</b>	<b>MonoMax</b> 56XXXX Series	STRUT & SHOCK			
MARQUE, MODELE ET	<b>Excel-G</b>		<b>AGX</b> 7XXXX Series	MOUNTS		BOOT KITS	
ANNEE DU VEHICULE	 	 	 	 	 		
LA MARCA EL MODELO & AÑO							

## JEEP Grand Cherokee

2005-10	ALL	341603	344496					SM5511			
1999-04	ALL (Exc. Up Country Susp.) ALL w/ Up Country Susp.	344341	344342	KG5744 555606	KG5197 555607	565106	565107				
1992-98	ALL (Exc. Up Country Susp.)	344088	344396	KG5464	KG5487	565053	565011				

## JEEP Grand Cherokee - Steering Stabilizer

1993-06	2WD & 4WD OEM Replacement Cylinder	SS10317									
---------	---------------------------------------	---------	--	--	--	--	--	--	--	--	--

## JEEP Grand Wagoneer

1993	ALL (Exc. Up Country Susp.)	344088	344396	KG5464	KG5487	565053	565011				
1984-91	ALL	344087	344085	KG5426	KG5419		565037				

## JEEP J-10, J-20

1974-90	ALL	344087	344085	KG5426	KG5419		565037				
---------	-----	--------	--------	--------	--------	--	--------	--	--	--	--

## JEEP Jeepster - Steering Stabilizer

1966-73	Complete Kit	SS15345									
---------	--------------	---------	--	--	--	--	--	--	--	--	--

## JEEP Liberty

2002-10	ALL	Right Hand Left Hand	331017 331017	344404 344404		KG5039 KG5039			SM5386 SM5387		
---------	-----	-------------------------	------------------	------------------	--	------------------	--	--	------------------	--	--

## JEEP Military Jeep

1941-53	Military MA, MB, MC Series	344426	344426	KG5401	KG5401						
---------	----------------------------	--------	--------	--------	--------	--	--	--	--	--	--

## JEEP Patriot

2007-09	ALL	Right Hand Left Hand	334642 334643	341654 341654						SB101 SB101	SB107 SB107
---------	-----	-------------------------	------------------	------------------	--	--	--	--	--	----------------	----------------

## JEEP Scrambler

1982-86	ALL	344087	344085	KG5426	KG5419		565037				
1981	ALL	344426	344085	KG5401	KG5419		565037				

## JEEP Scrambler - Steering Stabilizer

1981-86	Complete Kit OEM Replacement Cylinder	SS15345 SS10316									
---------	--	--------------------	--	--	--	--	--	--	--	--	--

## JEEP TJ (Canadian Vehicle)

1996-05	ALL	344435	344403	KG54323	KG54324	565020	565021				
---------	-----	--------	--------	---------	---------	--------	--------	--	--	--	--

## JEEP TJ - Steering Stabilizers













1996-05	DANA #30 fits axles up to 2 3/4" diameter Complete Kit Replacement Unit	SS15345 SS10317									
---------	---	--------------------	--	--	--	--	--	--	--	--	--

## JEEP Universal (CJ, DJ-Postal Dispatcher)

1961-65	CJ2A, 3A, 3B Series	344426	344426	KG5401	KG5401						
1961-67	CJ5, CJ6, CJ7 (Exc. w/ 5 Leaf Front Spring) CJ5, CJ6 w/ 5 Leaf Front Springs	344426 344426	344085 344426	KG5401 KG5401	KG5419 KG5401		565037				

Notes de bas de Page 320 - Guia de notas al calce del catalogo Pg. 321  
 Bold part numbers indicate the most comparable KYB product to the original design & performance.  
 (2) For vehicles with Electronic Susp., Leveling Control, and Air Suspensions refer to Appendix C.

# Applications For Pass. Cars, Light Trucks, SUV's, & Vans

VEHICLE MAKE, MODEL & YEAR	  	STRUT & SHOCK		BOOT KITS	
MARQUE, MODELE ET		MOUNTS			
ANNEE DU VEHICULE					
LA MARCA EL MODELO & AÑO					
	 	 	 	 	 

## JEEP Universal (CJ, DJ-Postal Dispatcher) (continued)

1964-67	CJ5A, CJ6A (Exc. w/ 5 Leaf Front Spring) CJ5A, CJ6A w/ 5 Leaf Front Spring	344426 344426	344085 344426	KG5401 KG5401	KG5419 KG5401		565037				
1965-67	DJ5, DJ6	344426	344085	KG5401	KG5419		565037				
1961-64	Dispatcher DJ3A Series	344426	344426	KG5401	KG5401						

## JEEP Wagoneer

1984-90	ALL (101" W.B.)	344088	344418	KG5464	KG5465	565053	565054				
1976-83	ALL	344087	344085	KG5426	KG5419		565037				
1974-75	ALL	344087		KG5426							
1966-73	ALL	344426	344426	KG5401	KG5401						
1963-65	ALL (Exc. Independent Front Susp.)	344426	344426	KG5401	KG5401						

## JEEP Wagoneer - Steering Stabilizer

1984-90	2WD & 4WD OEM Replacement Cylinder DANA #30 fits axles up to 2 3/4" diameter Complete Kit	SS10317 SS15345									
---------	---	--------------------	--	--	--	--	--	--	--	--	--

## JEEP Willys (CJ, DJ & Military)

1956-62	Dispatcher DJ3A Series	344426	344426	KG5401	KG5401						
1955-62	CJ5, CJ6 (Exc. w/ 5 Leaf Front Spring) CJ5, CJ6 w/ 5 Leaf Front Springs	344426 344426	344085 344426	KG5401 KG5401	KG5419 KG5401		565037				
1945-62	CJ2A, 3A, 3B Series	344426	344426	KG5401	KG5401						
1941-53	Military MA, MB, MC Series	344426	344426	KG5401	KG5401						

## JEEP Wrangler

2007-10	4WD RWD	349071 349071	349069	554364 554364	554365						
1997-06	ALL	344435	344403	KG54323	KG54324	565020	565021				
1987-96	ALL	344091	344092	KG5467	KG5468	565055	565056				

## JEEP Wrangler - Steering Stabilizer

2007-08	Replacement Unit	SS11318									
1987-06	DANA #30 fits axles up to 2 3/4" diameter Complete Kit Replacement Unit	SS15345 SS10317									

## JEEP Wrangler - Lift Replacement Shocks











1997-04	for Edelbrock # 63501 Lift = 2 1/2-4" for Rancho # RS5255 Lift = 2 1/2-4" for Rancho # RS9255 Lift = 2 1/2-4" for Rancho # RSX17339 Lift = 2 1/2-4" for Edelbrock # 64501 Lift = 2 1/2-4" for Rancho # RS5256 Lift = 2 1/2-4" for Rancho # RS9256 Lift = 2 1/2-4" for Rancho # RSX17340 Lift = 2 1/2-4"					565096 565096 565096 565096		565097 565097 565097 565097				
---------	--	--	--	--	--	--------------------------------------	--	--------------------------------------	--	--	--	--

## JEEP YJ (Canadian Vehicle)

1987-95	ALL	344091	344092	KG5467	KG5468	565055	565056				
---------	-----	--------	--------	--------	--------	--------	--------	--	--	--	--

Notes de bas de Page 320 - Guia de notas al calce del catalogo Pg. 321  
 Bold part numbers indicate the most comparable KYB product to the original design & performance.  
 (22) For vehicles with Electronic Susp., Leveling Control, and Air Suspensions refer to Appendix C.

# Applications For Pass. Cars, Light Trucks, SUV's, & Vans

VEHICLE MAKE, MODEL & YEAR	<b>GR-2</b>	<b>Gas-a-Just</b>	<b>MonoMax</b> 56XXXX Series	STRUT & SHOCK	
MARQUE, MODELE ET	<b>Excel-G</b>		<b>AGX</b> 7XXXX Series	MOUNTS	BOOT KITS
ANNEE DU VEHICULE	 	 	 	 	 
LA MARCA EL MODELO & AÑO					

## JEEP YJ - Steering Stabilizer

1987-96	DANA #30 fits axles up to 2 3/4" diameter Complete Kit Replacement Unit	SS15345								
		SS10317								

## KIA Amanti

2007-09	ALL	341482	349060					SM5517	SM5517	SB103	
2004-06	ALL	341481	341483					SM5517	SM5517	SB101	SB101

## KIA Magentis (Canadian Vehicle)

2007-09	ALL	Left Hand Right Hand	334509 334508	344501 344501							
2006	ALL (New Style)	Right Hand Left Hand	334508 334509	344501 344501							
	ALL (Old Style)		341280	341281				SM5460	SM5091	SB101	SB101
2001-05	ALL		341280	341281				SM5460	SM5091	SB101	SB101

## KIA Optima

2007-10	ALL	Left Hand Right Hand	334509 334508	344501 344501							SB102 SB102
2006	ALL w/ Engine Vin 3 & 4 (New Style)	Right Hand Left Hand	334508 334509	344501 344501							
	ALL w/ Engine Vin 6 & 8 (Old Style)		341280	341281				SM5460	SM5091	SB101	SB101
2001-05	ALL		341280	341281				SM5460	SM5091	SB101	SB101

## KIA Rio

2006-10	ALL			348007 <sup>68</sup>							SB102 SB107
2002-05	ALL	Right Hand Left Hand	333512 333513	343424 <sup>89</sup> 343424 <sup>89</sup>				SM5477 SM5478			SB102 SB102
2001-7/1/02	ALL	Right Hand Left Hand	333502 333503	343353 343353				SM5454 SM5454			SB102 SB102

## KIA Rio5

2006-10	ALL			348007 <sup>68</sup>							SB102 SB107
---------	-----	--	--	----------------------	--	--	--	--	--	--	----------------

## KIA Rondo

2007-10	ALL	Right Hand Left Hand	334508 334509	344501 344501							SB102 SB102
---------	-----	-------------------------	------------------	------------------	--	--	--	--	--	--	----------------

## KIA Sedona

2006-10	ALL			349094						SM5539		SB105
2002-05	ALL	Right Hand Left Hand	335063 335064	344296 344296				SM5151 SM5151				SB101 SB101

## KIA Sephia

1998-01	Strut Mount w/ Bearing									SM5308		
1998-5/00	ALL	Right Hand Left Hand	333262 333263	333264 333265				SM5076 SM5076 SM5129	SM5232 SM5233			SB101 SB101 SB101
	Strut Mount Bearing											
1994-97	ALL (Exc. ABS)	Right Hand Left Hand	333109 333110	333111 333111				SM5234 SM5234	SM5232 SM5233			

<sup>68</sup> New Part Number; Available 3rd Quarter 2011

<sup>89</sup> When [343424] stock is depleted, use [343353]

Notes de bas de Page 320 - Guia de notas al calce del catalogo Pg. 321

Bold part numbers indicate the most comparable KYB product to the original design & performance.

(22) For vehicles with Electronic Susp., Leveling Control, and Air Suspensions refer to Appendix C.



# Applications For Pass. Cars, Light Trucks, SUV's, & Vans

VEHICLE MAKE, MODEL & YEAR		<b>GR-2</b>		<b>Gas-a-Just</b>		<b>MonoMax</b> 56XXXX Series		STRUT & SHOCK		BOOT KITS	
MARQUE, MODELE ET		<b>Excel-G</b>				<b>AGX</b> 7XXXX Series		MOUNTS			
ANNEE DU VEHICULE											
LA MARCA EL MODELO & AÑO											

## KIA Sorento

2009	Strut / Shock Boot											SB101	
2007-08	ALL							SM5455				SB101	
2003-06	ALL (Exc. Self leveling)	Right Hand	341364	349005				SM5455				SB101	
		Left Hand	341365	349005				SM5455				SB101	

## KIA Spectra

2009	ALL	Right Hand	333490					SM5193	SM5074	SB101	SB108		
		Left Hand	333491					SM5193	SM5074	SB101	SB108		
2007-08	ALL	Right Hand	333490					SM5193	SM5074	SB101	SB108		
		Left Hand	333491					SM5193	SM5074	SB101	SB108		
2005-06	ALL	Right Hand	333490	333492				SM5193	SM5074	SB101	SB108		
		Left Hand	333491	333493				SM5193	SM5074	SB101	SB108		
2004	ALL 2.0L	Right Hand	333490	333492				SM5193	SM5074	SB101	SB108		
		Left Hand	333491	333493				SM5193	SM5074	SB101	SB108		
2003-04	ALL 1.8L	Right Hand	333316	333364				SM5479	SM5481	SB101	SB108		
		Left Hand	333317	333365				SM5479	SM5480	SB101	SB108		
2002	ALL w/ ABS Strut Mount (Sedan) Mount w/ Bearing (Hatchback)	Right Hand	333316	333364					SM5481	SB101	SB108		
		Left Hand	333317	333365				SM5479 SM5308	SM5480	SB101	SB108		
6/25/01-02	ALL (Exc. ABS) Mount w/ Bearing (Hatchback) Strut Mount (Sedan)	Right Hand	333316	333364					SM5481	SB101	SB108		
		Left Hand	333317	333365				SM5308 SM5479	SM5480	SB101	SB108		
00-6/25/01	ALL (Exc. ABS)	Right Hand	333314	333264				SM5308	SM5481	SB101	SB108		
		Left Hand	333315	333265				SM5308	SM5480	SB101	SB108		
2000-01	ALL w/ ABS	Right Hand	333314	333264				SM5308	SM5481	SB101	SB108		
		Left Hand	333315	333265				SM5308	SM5480	SB101	SB108		

## KIA Spectra5

2009	ALL	Right Hand	333490										
		Left Hand	333491										
2008	ALL	Right Hand	333490					SM5193	SM5074	SB101	SB108		
		Left Hand	333491					SM5193	SM5074	SB101	SB108		
2005-07	ALL	Right Hand	333490	333492				SM5193	SM5074	SB101	SB108		
		Left Hand	333491	333493				SM5193	SM5074	SB101	SB108		

## KIA Sportage

2005-10	ALL	Right Hand	334502	334504				SM5295	SM5239	SB105	SB105		
		Left Hand	334503	334505				SM5295	SM5239	SB105	SB105		
1999-02	ALL Upper Spring Seat Insulator	Right Hand	341394	344359		KG5745		SM5453		SB108			
		Left Hand	341395	344359		KG5745		SM5453 SM5416		SB108			
1995-98	ALL Upper Spring Seat Insulator		341190			KG5745		SM5453 SM5416		SB108			

## LANDROVER Discovery

1999-04	Series II w/ Air Susp. (Exc. Active Cornering Enhancement)	345036	345037										
	Series II w/ Coil Spring (Exc. Active Cornering Enhancement)	345036	345037										
	Series II w/ Air Susp. & Active Cornering Enhancement		345037										
	Series II w/ Coil Spring & Active Cornering Enhancement		345037										

Notes de bas de Page 320 - Guia de notas al calce del catalogo Pg. 321  
 Bold part numbers indicate the most comparable KYB product to the original design & performance.  
 (22) For vehicles with Electronic Susp., Leveling Control, and Air Suspensions refer to Appendix C.

# Applications For Pass. Cars, Light Trucks, SUV's, & Vans

VEHICLE MAKE, MODEL & YEAR	<b>GR-2</b>		<b>Gas-a-Just</b>		<b>MonoMax</b> 56XXXX Series		STRUT & SHOCK			
MARQUE, MODELE ET	<b>Excel-G</b>				<b>AGX</b>		MOUNTS		BOOT KITS	
ANNEE DU VEHICULE					7XXXXX Series					
LA MARCA EL MODELO & AÑO										

## LANDROVER Discovery (continued)

1994-99	ALL (Exc. Series II)		345014	345005							
---------	----------------------	--	--------	--------	--	--	--	--	--	--	--

## LANDROVER Freelander

2002-05	ALL	Right Hand	335926	334623						SB105	
		Left Hand	335927	334624						SB105	

## LANDROVER LR2

2008-10	Strut / Shock Boot									SB102	SB102
---------	--------------------	--	--	--	--	--	--	--	--	-------	-------

## LANDROVER Range Rover

1995-02	ALL w/ Air Susp.		345038	345039							
---------	------------------	--	--------	--------	--	--	--	--	--	--	--

## LEXUS ES250

1990-92	ALL (Struts)	Right Hand	235041	235042					SM5049	SM5375	SB105	SB105
		Left Hand	235041	235043					SM5049	SM5375	SB105	SB105
	ALL (Cartridges)		365061	365062					SM5049	SM5375	SB105	SB105

## LEXUS ES300

2002-03	ALL (Exc. Adj. Susp.)	Right Hand	334338	334340					SM5423	SM5175	SB102	SB101
	Upper Spring Seat w/ Insulator	Left Hand	334339	334341					SM5423	SM5175	SB102	SB101
	Lower Spring Seat Insulator								SM5485			
									SM5441	SM5469		
1997-01	ALL (Exc. Adj. Susp.)	Right Hand	334245	334133					SM5179	SM5175	SB101	SB101
	Upper Spring Seat w/ Insulator	Left Hand	334246	334134					SM5180	SM5175	SB101	SB101
	Lower Spring Seat Insulator								SM5485			
									SM5441	SM5469		
1995-96	ALL	Right Hand	334170	334133					SM5174	SM5185	SB101	SB101
	Upper Spring Seat w/ Insulator	Left Hand	334171	334134					SM5174	SM5185	SB101	SB101
	Upper Spring Seat Insulator								SM5485			
	Lower Spring Seat Insulator								SM5468	SM5469		
1992-94	ALL w/ Sealed struts	Right Hand	334131	334133					SM5385	SM5185	SB101	SB101
	ALL w/ Serviceable Struts	Left Hand	334132	334134					SM5385	SM5185	SB101	SB101
	Strut Mount w/ Bearing		365085	365062					SM5385	SM5185	SB101	SB101
	Lower Spring Seat Bearing (Only)								SM5126			
	Lower Spring Seat Assembly								SM5125			
	Upper Spring Seat Insulator								SM5173			
	Lower Spring Seat Insulator								SM5468	SM5469		

## LEXUS ES330



2005-06	ALL (Exc. Adj. Susp.)	Right Hand	334386	334388					SM5423	SM5175	SB102	SB101
	Upper Spring Seat w/ Insulator	Left Hand	334387	334389					SM5423	SM5175	SB102	SB101
									SM5485			
2004	ALL (Exc. Adj. Susp.)	Right Hand	334386	334388					SM5423	SM5175	SB102	SB101
	Upper Spring Seat w/ Insulator	Left Hand	334387	334389					SM5423	SM5175	SB102	SB101
									SM5485			

## LEXUS ES350

8/2009-11	ALL	Right Hand	339183	335059								
		Left Hand	339184	335060								
07-7/2009	ALL	Right Hand	339023	335059							SB102	SB101
	Upper Spring Seat w/ Insulator	Left Hand	339024	335060							SB102	SB101
									SM5485			

Notes de bas de Page 320 - Guia de notas al calce del catalogo Pg. 321  
 Bold part numbers indicate the most comparable KYB product to the original design & performance.  
 (2) For vehicles with Electronic Susp., Leveling Control, and Air Suspensions refer to Appendix C.

# Applications For Pass. Cars, Light Trucks, SUV's, & Vans

VEHICLE MAKE, MODEL & YEAR		<b>GR-2</b>		<b>Gas-a-Just</b>		<b>MonoMax</b> 56XXXX Series		STRUT & SHOCK			
MARQUE, MODELE ET		<b>Excel-G</b>				<b>AGX</b> 7XXXXX Series		MOUNTS		BOOT KITS	
ANNEE DU VEHICULE											
LA MARCA EL MODELO & AÑO											
											

## LEXUS GS300

2006	AWD Right Hand Left Hand										
	FWD Right Hand Left Hand			551106 551107	551108 551108						
1998-05	ALL	341266	341267					SM5205		SB103	SB103
1996-97	ALL	341196	341197					SM5205		SB103	SB103
1993-95	ALL	341196	341197								

## LEXUS GS350

2007-10	AWD (Exc. Adaptive Control Suspension) Right Hand Left Hand				551108 551108						
	FWD (Exc. Adaptive Control Suspension) Right Hand Left Hand			551106 551107	551108 551108						

## LEXUS GS400

1998-00	ALL	341266	341267					SM5205		SB103	
---------	-----	--------	--------	--	--	--	--	--------	--	-------	--

## LEXUS GS430

2001-05	ALL (Exc. Adj. Susp.)	341266	341267					SM5205		SB103	
---------	-----------------------	--------	--------	--	--	--	--	--------	--	-------	--

## LEXUS GX470

2003-2/04	Upper Spring Seat Isolator							SM5413			
-----------	----------------------------	--	--	--	--	--	--	--------	--	--	--

## LEXUS IS250

2006-10	AWD Right Hand Left Hand			551126 <sup>70</sup> 551127 <sup>70</sup>							
---------	--------------------------------	--	--	--	--	--	--	--	--	--	--

## LEXUS IS300

2004-05	Sedan	341262						SM5490		SB101	SB103
2001-03	Sedan	341262	341263					SM5490		SB101	SB103

## LEXUS LS400

1995-00	ALL (Exc. Elec. Pneumatic Susp.)	341159	341269					SM5563	SM5177	SB101	SB104
1990-94	ALL (Exc. Elec. Pneumatic Susp.)	341159	341268					SM5176	SM5178		

## LEXUS LS430

2001-06	ALL (Exc. Adj. Susp.)	341392	341393					SM5565 <sup>70</sup>	SM5566 <sup>70</sup>	SB104	SB102
---------	-----------------------	--------	--------	--	--	--	--	----------------------	----------------------	-------	-------

## LEXUS LX450

1996-97	ALL (Coil Spring Front Susp..) (Exc. Adj. Susp.)			KG54300	KG54301	565026	565027				
---------	---	--	--	---------	---------	--------	--------	--	--	--	--

## LEXUS LX470

1998-07	ALL (Torsion Bar Front Susp.) (Exc. Adj. Susp.)	345022	345023								
---------	---	--------	--------	--	--	--	--	--	--	--	--













## LEXUS RX300 (AWD)

1999-03	ALL Right Hand Left Hand	334261 334262	334263 334264					SM5179 SM5180 SM5485	SM5175 SM5175	SB101 SB101	SB101 SB101
	Upper Spring Seat w/ Insulator										

<sup>70</sup> New Part Number, Available 2nd Quarter 2011

Notes de bas de Page 320 - Guia de notas al calce del catalogo Pg. 321  
 Bold part numbers indicate the most comparable KYB product to the original design & performance.  
 (22) For vehicles with Electronic Susp., Leveling Control, and Air Suspensions refer to Appendix C.

# Applications For Pass. Cars, Light Trucks, SUV's, & Vans

VEHICLE MAKE, MODEL & YEAR	  	STRUT & SHOCK		BOOT KITS	
MARQUE, MODELE ET		MOUNTS			
ANNEE DU VEHICULE					
LA MARCA EL MODELO & AÑO					
	 	 	 	 	 

## LEXUS RX300 (AWD) (continued)

1999-03	Lower Spring Seat Insulator								SM5469		
---------	-----------------------------	--	--	--	--	--	--	--	--------	--	--

## LEXUS RX300 (FWD)

1999-03	ALL	Right Hand	334261	334269					SM5179	SM5175	SB101	SB101
		Left Hand	334262	334270					SM5180	SM5175	SB101	SB101
	Upper Spring Seat w/ Insulator								SM5485			
	Lower Spring Seat Insulator									SM5469		

## LEXUS RX330 (AWD)

2004-06	ALL w/o Air Susp.	Right Hand	334399 <sup>64</sup>	235908 <sup>83</sup>					SM5423	SM5491	SB102	SB104
		Left Hand	334400 <sup>65</sup>	235909 <sup>84</sup>					SM5423	SM5492	SB102	SB104
	Upper Spring Seat w/ Insulator, w/o Air Susp.								SM5485			
	Lower Spring Seat Insulator, w/o Air Susp.									SM5469		

## LEXUS RX330 (FWD)

2004-06	ALL w/o Air Susp.	Right Hand	334399 <sup>64</sup>	235906					SM5423	SM5491	SB102	SB104
		Left Hand	334400 <sup>65</sup>	235907					SM5423	SM5492	SB102	SB104
	Upper Spring Seat w/ Insulator, w/o Air Susp.								SM5485			
	Lower Spring Seat Insulator, w/o Air Susp.									SM5469		

## LEXUS RX350 (AWD)

2008-09	ALL w/o Air Susp. (USA Built)	Right Hand	334399									
		Left Hand	334400									
	ALL w/o Air Susp. (Japan Built)	Right Hand	334399	339132 <sup>70</sup>								
		Left Hand	334400	339133 <sup>70</sup>								
2007	ALL w/o Air Susp.	Right Hand	334399 <sup>64</sup>	235908 <sup>83</sup>					SM5423	SM5491	SB102	SB104
		Left Hand	334400 <sup>65</sup>	235909 <sup>84</sup>					SM5423	SM5492	SB102	SB104
	Upper Spring Seat w/ Insulator, w/o Air Susp.								SM5485			

## LEXUS RX350 (FWD)





2008-09	ALL w/o Air Susp. (USA Built)	Right Hand	334399									
		Left Hand	334400									
	ALL w/o Air Susp. (Japan Built)	Right Hand	334399	339208 <sup>70</sup>								
		Left Hand	334400	339209 <sup>70</sup>								
2007	ALL w/o Air Susp.	Right Hand	334399 <sup>64</sup>	235906					SM5423	SM5491	SB102	SB104
		Left Hand	334400 <sup>65</sup>	235907					SM5423	SM5492	SB102	SB104
	Upper Spring Seat w/ Insulator, w/o Air Susp.								SM5485			

## LEXUS RX400H (AWD)

2008	ALL	Right Hand	334399	339208 <sup>70</sup>					SM5423	SM5491	SB102	SB104
		Left Hand	334400	339209 <sup>70</sup>					SM5423	SM5492	SB102	SB104
	Upper Spring Seat w/ Insulator								SM5485			
	Lower Spring Seat Insulator									SM5469		

<sup>64</sup> Replaces [235904], when stock is depleted  
<sup>65</sup> Replaces [235905], when stock is depleted  
<sup>70</sup> New Part Number, Available 2nd Quarter 2011  
<sup>83</sup> When [235908] stock is depleted, use [334394]  
<sup>84</sup> When [235909] stock is depleted, use [334395]

# Applications For Pass. Cars, Light Trucks, SUV's, & Vans

VEHICLE MAKE, MODEL & YEAR		<b>GR-2</b>		<b>Gas-a-Just</b>		<b>MonoMax</b> 56XXXX Series		STRUT & SHOCK			
MARQUE, MODELE ET		<b>Excel-G</b>				<b>AGX</b> 7XXXX Series		MOUNTS		BOOT KITS	
ANNEE DU VEHICULE											
LA MARCA EL MODELO & AÑO											

## LEXUS RX400H (AWD) (continued)

2006-07	ALL	Right Hand Left Hand	334399 334400	339210 <sup>70</sup> 339211 <sup>70</sup>					SM5423 SM5423 SM5485	SM5491 SM5492 SM5469	SB102 SB102	SB104 SB104
		Upper Spring Seat w/ Insulator Lower Spring Seat Insulator										

## LEXUS RX400H (FWD)

2008	ALL	Right Hand Left Hand	334399 334400	339212 <sup>70</sup> 339213 <sup>70</sup>					SM5423 SM5423 SM5485	SM5491 SM5492 SM5469	SB102 SB102	SB104 SB104
		Upper Spring Seat w/ Insulator Lower Spring Seat Insulator										
2006-07	ALL	Right Hand Left Hand	334399 334400	334384 334385					SM5423 SM5423 SM5485	SM5491 SM5492 SM5469	SB102 SB102	SB104 SB104
		Upper Spring Seat w/ Insulator Lower Spring Seat Insulator										

## LEXUS SC300

1992-00	ALL		341161	341162					SM5564	SM5186	SB101	SB103
---------	-----	--	--------	--------	--	--	--	--	--------	--------	-------	-------

## LEXUS SC400

1994-00	ALL		341161	341162					SM5564	SM5186	SB101	SB103
1992-93	ALL		341161	341162						SM5186	SB101	SB104

## LEXUS SC430

2006-10	ALL								SM5205		SB103	
2002-05	ALL		341266						SM5205		SB103	

## LINCOLN Aviator

2003-05	ALL		341679 <sup>70</sup>	341680 <sup>70</sup>								
---------	-----	--	----------------------	----------------------	--	--	--	--	--	--	--	--

## LINCOLN Blackwood

2002-03	ALL		NA	NA								
---------	-----	--	----	----	--	--	--	--	--	--	--	--

## LINCOLN Continental

1997-02	ALL w/ Passive Suspension	Right Hand Left Hand	335929 335930	344614 344614								
1995-96	ALL w/ Semi-Active Suspension	Right Hand Left Hand	SR3001 SR3002	SR3003 SR3003								
1982-87	ALL		235008	343162		KG5556					SB103	
1970-81	ALL		343128	343149	KG4515	KG5522						

## LINCOLN LS

2003-05	ALL		341655	341656								
---------	-----	--	--------	--------	--	--	--	--	--	--	--	--











## LINCOLN MKX

2010	Strut / Shock Boot										SB102	
2007-09	ALL	Right Hand Left Hand	334644 334645	349068 349068							SB102 SB102	

<sup>70</sup> New Part Number, Available 2nd Quarter 2011

Notes de bas de Page 320 - Guia de notas al calce del catalogo Pg. 321  
 Bold part numbers indicate the most comparable KYB product to the original design & performance.  
 (22) For vehicles with Electronic Susp., Leveling Control, and Air Suspensions refer to Appendix C.

# Applications For Pass. Cars, Light Trucks, SUV's, & Vans

VEHICLE MAKE, MODEL & YEAR	<b>GR-2</b>	<b>Gas-a-Just</b>	<b>MonoMax</b> 56XXXX Series	STRUT & SHOCK	
MARQUE, MODELE ET	<b>Excel-G</b>		<b>AGX</b> 7XXXX Series	MOUNTS	BOOT KITS
ANNEE DU VEHICULE	 	 	 	 	 
LA MARCA EL MODELO & AÑO					

## LINCOLN MKZ

2010	Strut / Shock Boot									SB101
2007-10	Mount & Spring Seat w/ Insulator							SM5540		
2007-09	AWD	Right Hand	341405	349033						SB101
		Left Hand	341406	349033						SB101
	FWD	Right Hand	341405	344363						SB101
		Left Hand	341406	344363						SB101

## LINCOLN Mark LT

2006-08	Strut Mount w/o Off Road Susp. (Incl. Black Boot & Bumper)							SM5424		
2006	2WD	341602	344414		KG5193					

## LINCOLN Mark Series

1984-92	Mark VII	235008	343162		KG5556			SM5054		SB103
1980-83	Mark VI	343128	343135	KG4515	KG5521					
1977-79	Mark V	343128		KG4515	KG5519					
1973-76	Mark IV	343128		KG4515	KG5519					
1972	Mark IV	343128	343135	KG4515	KG5521					
1969-71	Mark III	343128	343149	KG4515	KG5522					

## LINCOLN Navigator

2003-05	2WD							SM5424		
	Strut Mount (Includes Black Strut Boot)							SM5425		
	4WD									
	Strut Mount w/ Off Road Susp. (Includes Red Strut Boot)							SM5424		
	Strut Mount w/o Off Road Susp. (Incl. Black Boot & Bumper)									
2003	Strut Mount w/o Air Susp.							SM5426		
1998-02	4WD w/ Four Corner Air Leveling System			NA	NA					
	RWD (Exc. Rear Air Leveling)	344367	344267	KG54311	KG54320	565004				
	RWD w/ Rear Air Leveling	344367		KG54311	KG54319	565004	565005			

## LINCOLN Town Car

2003-08	ALL			551600	555601 <sup>59</sup>			SM5392	SM5267	
1990-02	ALL			KG5572	KG5521					
1982-89	ALL (Exc. Limousine) Limousine	343128	343149	KG4515	KG5522					
				KG5458	KG5522					
1981	ALL	343128	343149	KG4515	KG5522					

## LINCOLN Versailles

1977-80	ALL	343133	343136							
---------	-----	--------	--------	--	--	--	--	--	--	--





## LINCOLN Zephyr

2006	ALL	Right Hand	341405	344363						SB101
		Left Hand	341406	344363						SB101
	Mount & Spring Seat w/ Insulator							SM5540		

<sup>59</sup> Mount kit [SM5267] required with [555601], or [555603]

Notes de bas de Page 320 - Guia de notas al calce del catalogo Pg. 321  
 Bold part numbers indicate the most comparable KYB product to the original design & performance.  
 (22) For vehicles with Electronic Susp., Leveling Control, and Air Suspensions refer to Appendix C.

# Applications For Pass. Cars, Light Trucks, SUV's, & Vans

VEHICLE MAKE, MODEL & YEAR			<b>GR-2</b>		<b>Gas-a-Just</b>		<b>MonoMax</b> 56XXXX Series		STRUT & SHOCK			
MARQUE, MODELE ET			<b>Excel-G</b>				<b>AGX</b> 7XXXX Series		MOUNTS		BOOT KITS	
ANNEE DU VEHICULE												
LA MARCA EL MODELO & AÑO												

## MAZDA 3

2010	ALL (Exc. Mazdaspeed)	Right Hand Left Hand	334700 334701								SB101 SB101	
2004-09	ALL (Exc. Mazdaspeed)	Right Hand Left Hand	334700 334701	343412 343412							SB101 SB101	

## MAZDA 323 (Exc. Elec. Adj. Suspension) (also see STRUT-PLUS)

1990-94	FWD	Right Hand Left Hand	234037 234038	234039 234040					SM5044 SM5044 SM5305 SM5155	SM5046 SM5046	SB101 SB101	SB118 SB118
	Strut Mount w/ Bearing Upper Spring Seat											
1990-91	AWD	Right Hand Left Hand	234037 234038						SM5044 SM5044	SM5046 SM5046	SB101 SB101	SB118 SB118
1986-89	AWD	Right Hand Left Hand	234008 234009								SB102 SB102	SB102 SB102
	Sedan & Hatchback (FWD) (For Adapting ASA to Non-ASA Suspension)											
		Right Hand Left Hand	234008 <sup>c</sup> 234009 <sup>c</sup>	232011 <sup>c</sup> 232012 <sup>c</sup>							SB102 SB102	SB118 SB118
	Sedan & Hatchback (FWD)	Right Hand Left Hand	234008 234009	232011 232012					SM5039 SM5039	SM5045 SM5045	SB102 SB102	SB118 SB118
	Wagon	Right Hand Left Hand	234008 234009								SB102 SB102	SB102 SB102

## MAZDA 323 (Exc. Elec. Adj. Suspension) - STRUT-PLUS

1990-94	FWD	Right Hand Left Hand	SR4005 SR4006	SR4007 SR4008								
---------	-----	-------------------------	------------------	------------------	--	--	--	--	--	--	--	--

## MAZDA 5

2008-10	Strut / Shock Boot			343412							SB101	
2006-07	ALL	Right Hand Left Hand	334700 334701	343412 343412							SB101 SB101	

## MAZDA 6

2009-10	ALL	Right Hand Left Hand	341449 341450	349063 349063								
2005-08	ALL (Exc. Mazdaspeed)	Right Hand Left Hand	341351 341352	344363 344363							SB101 SB101	
	Mount, Spring Seat & Bearing								SM5540			
2/3/04 - 04	Mount, Spring Seat & Bearing								SM5540			
2003-04	ALL	Right Hand Left Hand	341351 341352	344363 344363					SM5428 SM5428		SB101 SB101	

## MAZDA 626 (Exc. Electronically-Adjustable Suspension)

2000-02	ALL	Right Hand Left Hand	334401 334402	334449 334449					SM5459 SM5459	SM5408 SM5407	SB101 SB101	SB105 SB105
1998-99	ALL	Right Hand Left Hand	334401 334402	334449 334449					SM5459 SM5459	SM5094 SM5093	SB101 SB101	SB105 SB105
1993-99	Strut Mount Bearing								SM5129			
1993-7/97	ALL	Right Hand Left Hand	235601 235602	235603 235603					SM5076 SM5076	SM5094 SM5093	SB101 SB101	SB101 SB101
1993-97	Strut Mounting Kit Upper Spring Seat								SM5308 SM5346			
1990-92	Mount & Bearing - Auto Trans (Exc. 4WS & Adj. Susp.)								SM5300			













<sup>c</sup> To convert from Electronic Susp - See Appendix C

Notes de bas de Page 320 - Guia de notas al calce del catalogo Pg. 321

Bold part numbers indicate the most comparable KYB product to the original design & performance.

(22) For vehicles with Electronic Susp., Leveling Control, and Air Suspensions refer to Appendix C.

# Applications For Pass. Cars, Light Trucks, SUV's, & Vans

VEHICLE MAKE, MODEL & YEAR	  	STRUT & SHOCK		BOOT KITS	
MARQUE, MODELE ET		MOUNTS			
ANNEE DU VEHICULE					
LA MARCA EL MODELO & AÑO					
	 	 	 	 	 

## MAZDA 626 (Exc. Electronically-Adjustable Suspension) (continued)

1990-92	Mount & Bearing - Japan Built, Manual Trans. (Exc. 4WS & Adj. Susp.) Mount & Bearing - Manual Trans (Exc. 4WS & Adj. Susp.) Mount - Japan Built, Manual Trans. (Exc. 4WS & Adj. Susp.) Mount - Manual Trans (Exc. 4WS & Adj. Susp.) Strut Mount Bearing							SM5274 SM5274 SM5041 SM5041 SM5127			
1988-92	ALL (Exc. 4WS & Adj. Susp.) Right Hand Left Hand ALL (Exc. 4WS) (For Adapting AAS to Non-AAS Suspension) Right Hand Left Hand Spring Seat 4 cyl. Exc. Man. Trans. & 4WS Spring Seat	235046 235047 235046 <sup>c</sup> 235047 <sup>c</sup>	235048 235048 235606 <sup>c</sup> 235606 <sup>c</sup>					SM5300 SM5300 SM5341	SM5035 SM5035 SM5035	SB104 SB104 SB104 SB104	SB101 SB101 SB101 SB101
1988-91	Spring Seat (Man. Trans. w/ 4WS)							SM5343			
1988-89	Mount & Bearing - Auto Trans (Exc. 4WS & Adj. Susp.) Mount & Bearing - Manual Trans (Exc. 4WS & Adj. Susp.) Mount - Manual Trans (Exc. 4WS & Adj. Susp.) Strut Mount Bearing							SM5300 SM5274 SM5041 SM5127			
1986-87	ALL Right Hand Left Hand	233007 233008	233016 233016					SM5307 SM5307	SM5298 SM5299	SB101 SB101	SB101 SB101
1983-87	ALL (For Adapting AAS to Non-AAS Suspension) Right Hand Left Hand	233007 <sup>c</sup> 233008 <sup>c</sup>	234050 <sup>c</sup> 234050 <sup>c</sup>							SB101 SB101	SB101 SB101
1983-85	ALL Right Hand Left Hand	233007 233008	233016 233016					SM5047 SM5047	SM5298 SM5299	SB101 SB101	SB101 SB101
1979-82	ALL From Chassis No.CB2MS-543880	363022	343149					SM5304		SB103	
1979	ALL Thru Chassis No.CB2MS-543879		343149								

## MAZDA 929 (Exc. Electronically-Adjustable Suspension)

1990-91	ALL	NA	NA					SM5306			
1988-89	ALL	NA	NA					SM5301	SM5302		

## MAZDA CX-7

2010	Strut / Shock Boot									SB105	
2007-09	ALL Right Hand Left Hand	339155 339156	349076 349076							SB105 SB105	

## MAZDA CX-9

2010	Strut / Shock Boot									SB105	
2007-09	ALL Right Hand Left Hand	339140 339141	349070 349070							SB105 SB105	

## MAZDA GLC

1981-85	ALL FWD (Exc. Station Wagon) Right Hand Left Hand	233005 233006	232001 232002					SM5039 SM5039	SM5045 SM5045	SB103 SB103	SB101 SB101
---------	--	------------------	------------------	--	--	--	--	------------------	------------------	----------------	----------------

<sup>c</sup> To convert from Electronic Susp - See Appendix C



# Applications For Pass. Cars, Light Trucks, SUV's, & Vans

VEHICLE MAKE, MODEL & YEAR	<b>GR-2</b>		<b>Gas-a-Just</b>		<b>MonoMax</b> 56XXXX Series		STRUT & SHOCK			
MARQUE, MODELE ET	<b>Excel-G</b>				<b>AGX</b>		MOUNTS		BOOT KITS	
ANNEE DU VEHICULE					7XXXXX Series					
LA MARCA EL MODELO & AÑO										

## MAZDA MPV Mini-Van

8/00-06	ALL	Right Hand Left Hand	334418 334419	345024 345024					SM5458 SM5458		SB105 SB105	
2000-06	Strut Mount Bearing								SM5127			
2000-7/00	ALL	Right Hand Left Hand	334282 334283	345024 345024					SM5458 SM5458		SB105 SB105	
1996-98	2WD (Exc. Rear Self Leveling)	Right Hand Left Hand	236005 236006						SM5151 SM5151		SB105 SB105	
	2WD w/ Rear Self Leveling	Right Hand Left Hand	236005 236006				KG5198A KG5198A		SM5151 SM5151		SB105 SB105	
	4WD (Exc. Rear Self Leveling)	Right Hand Left Hand	236009 236010				KG54305 KG54305		SM5151 SM5151		SB104 SB104	
	4WD w/ Rear Self Leveling	Right Hand Left Hand	236009 236010				KG54305 KG54305		SM5151 SM5151		SB104 SB104	
1989-95	2WD (Exc. Rear Self Leveling)	Right Hand Left Hand	236005 236006				KG5198A KG5198A		SM5115 SM5115		SB104 SB104	
	2WD w/ Rear Self Leveling	Right Hand Left Hand	236005 236006				KG54305 KG54305		SM5115 SM5115		SB104 SB104	
	4WD (Exc. Rear Self Leveling)	Right Hand Left Hand	236009 236010				KG54305 KG54305		SM5115 SM5115		SB104 SB104	
	4WD w/ Rear Self Leveling	Right Hand Left Hand	236009 236010				KG54305 KG54305		SM5115 SM5115		SB104 SB104	

## MAZDA MX3

1992-95	ALL (Exc. ABS)	Right Hand Left Hand	234037 234038	234039 234040					SM5044 SM5044	SM5046 SM5046	SB105 SB105	SB118 SB118
	Strut Mounting Kit								SM5305			

## MAZDA MX6 (Exc. Electronically-Adjustable Suspension)

1993-97	ALL	Right Hand Left Hand	235601 235602	235603 235603					SM5076 SM5076	SM5094 SM5093	SB104 SB104	SB101 SB101
	Strut Mount w/ Bearing								SM5308			
	Strut Mount Bearing Upper Spring Seat								SM5129 SM5346			
1988-92	ALL (Exc. Elec. Susp. & 4WS)	Right Hand Left Hand	235046 235047	235048 235048						SM5035 SM5035	SB104 SB104	SB101 SB101
	GT (Exc. 4WS) (For Adapting AAS to Non-AAS Suspension)	Right Hand Left Hand	235046 <sup>c</sup> 235047 <sup>c</sup>	235606 <sup>c</sup> 235606 <sup>c</sup>							SB104 SB104	SB101 SB101
	Mount Kit, Auto Trans (Exc. 4WS)								SM5300			
	Mount, Manual Trans (Exc. 4WS) Strut Mount Bearing for SM5041 Spring Seat (Exc. Manual Trans. & 4WS)								SM5041 SM5127 SM5341			











## MAZDA Miata (MX5)

2009-10	ALL (Exc. Sport Susp.) (Exc. Run Flat Tires)						551118						
2009	Strut / Shock Boot										SB101	SB107	
2006-08	ALL (Exc. Sport Susp.) (Exc. Run Flat Tires)				551117	551118					SB101	SB107	
1999-05	ALL (Exc. Sports Package)		341253	341254				741035	741036	SM5139	SM5139	SB108	SB108
1990-97	ALL		341143	341127						SM5077	SM5077	SB108	SB108
	ALL (Exc. ABS)							741015	741016	SM5077	SM5077	SB108	SB108

<sup>c</sup> To convert from Electronic Susp - See Appendix C

Notes de bas de Page 320 - Guia de notas al calce del catalogo Pg. 321  
 Bold part numbers indicate the most comparable KYB product to the original design & performance.  
 (22) For vehicles with Electronic Susp., Leveling Control, and Air Suspensions refer to Appendix C.

# Applications For Pass. Cars, Light Trucks, SUV's, & Vans

VEHICLE MAKE, MODEL & YEAR	<i><b>GR-2</b></i>	<i><b>Gas-a-Just</b></i>	<i><b>MonoMax</b></i> 56XXXX Series	STRUT & SHOCK		BOOT KITS	
MARQUE, MODELE ET	<i><b>Excel-G</b></i>		<i><b>AGX</b></i>	MOUNTS			
ANNEE DU VEHICULE			7XXXXX Series				
LA MARCA EL MODELO & AÑO	 	 	 	 	 		

## MAZDA Millenia

1997-00	ALL		341259							
1995-8/95	2.5L, 2.3L		341316							

## MAZDA Navajo

1991-94	ALL	344268	344269	KG5489	KG5490	565001	565003				
---------	-----	--------	--------	--------	--------	--------	--------	--	--	--	--

## MAZDA Navajo - Lift Replacement Shocks

1991-94	ALL Lift = 0-2"					565082	565003				
---------	-----------------	--	--	--	--	--------	--------	--	--	--	--

## MAZDA Pickup (2WD)

2001-08	B2300	344397	344396	KG54328	KG5487						
2001-06	B3000, B4000 w/ Coil Spring Front Susp. (Exc. Dual Sport)	344397	344396	KG54328	KG5487						
	B3000, B4000 w/ Torsion Bar Front Susp. (Inc. Dual Sport)	341302	344079	KG54309	KG5493						
2001	B2500	344397	344396	KG54328	KG5487						
1998-00	B2300, B2500, B3000, B4000	344397	344396	KG54328	KG5487						
1994-97	B2300, B2500, B3000, B4000	344268	344396	KG5489	KG5487						
1986-93	ALL	344098	344044	KG5476	KG4012						
1972-84	ALL	343127	344052								

## MAZDA Pickup (4WD)

1998-06	B3000, B4000	341302	344079	KG54309	KG5493						
1994-97	B3000, B4000	344268	344079	KG5489	KG5493						
1987-93	ALL			KG5484	KG5485						
1972-84	ALL	343127	344052								

## MAZDA Protege (also see STRUT-PLUS)

2003	ALL (Exc. Mazdaspeed) w/o 4 Wheel Disc w/ 4 Wheel Disc	Right Hand	333350	333276					SM5457	SB101	SB102	
		Left Hand	333351	333277					SM5456	SB101	SB102	
8/00-02	ALL (Exc. MP3)	Right Hand	333350	333276					SM5427	SM5457	SB101	SB102
		Left Hand	333351	333277					SM5427	SM5456	SB101	SB102
1999-7/00	ALL	Right Hand	333274	333276					SM5427	SM5457	SB101	SB102
		Left Hand	333275	333277					SM5427	SM5456	SB101	SB102
1995-98	ALL	Right Hand	333182	333184					SM5150	SM5406	SB101	SB118
		Left Hand	333183	333185					SM5150	SM5405	SB101	SB118
1992-94	ALL	Right Hand	234037	234039					SM5044	SM5046	SB101	SB118
		Left Hand	234038	234040					SM5044	SM5046	SB101	SB118
1990-91	AWD	Right Hand	234037						SM5044	SM5046	SB101	SB101
		Left Hand	234038						SM5044	SM5046	SB101	SB101
	FWD	Right Hand	234037	234039					SM5044	SM5046	SB101	SB118
		Left Hand	234038	234040					SM5044	SM5046	SB101	SB118
Strut Mount w/ Bearing								SM5305				











## MAZDA Protege - STRUT-PLUS

1990-94	FWD	Right Hand	SR4005	SR4007							
		Left Hand	SR4006	SR4008							

Notes de bas de Page 320 - Guia de notas al calce del catalogo Pg. 321

Bold part numbers indicate the most comparable KYB product to the original design & performance.  
(2) For vehicles with Electronic Susp., Leveling Control, and Air Suspensions refer to Appendix C.

# Applications For Pass. Cars, Light Trucks, SUV's, & Vans

VEHICLE MAKE, MODEL & YEAR		<b>GR-2</b> <i>Excel-G</i>		<b>Gas-a-Just</b>		<b>MonoMax</b> 56XXXX Series <b>AGX</b> 7XXXXX Series		STRUT & SHOCK MOUNTS		BOOT KITS	
MARQUE, MODELE ET ANNEE DU VEHICULE		 		 		 		 		 	
LA MARCA EL MODELO & AÑO											

## MAZDA Protege 5

2002-03	ALL	Right Hand Left Hand	333350 333351	333276 333277							SB101 SB101	SB102 SB102
---------	-----	-------------------------	------------------	------------------	--	--	--	--	--	--	----------------	----------------

## MAZDA RX-4

1974-78	ALL			344052								
---------	-----	--	--	--------	--	--	--	--	--	--	--	--

## MAZDA RX-7 (Exc. Electronically-Adjustable Susp.)

1993-95	ALL	Right Hand Left Hand	341168 341169	341170 341170								
1989-91	Turbo (For Adapting AAS to Non-AAS Suspension)	Right Hand Left Hand	235012 <sup>C</sup> 235013 <sup>C</sup>		KG9132 <sup>C</sup> KG9132 <sup>C</sup>	733012 <sup>C</sup> 733013 <sup>C</sup>	741025 <sup>C</sup> 741025 <sup>C</sup>	SM5303 SM5303			SB103 SB103	SB107 SB107
1986-91	ALL	Right Hand Left Hand	235012 235013		KG9132 KG9132	733012 733013	741025 741025	SM5303 SM5303			SB103 SB103	SB107 SB107
1986-88	GXL (For Adapting AAS to Non-AAS Suspension)	Right Hand Left Hand	235012 <sup>C</sup> 235013 <sup>C</sup>		KG9132 <sup>C</sup> KG9132 <sup>C</sup>	733012 <sup>C</sup> 733013 <sup>C</sup>	741025 <sup>C</sup> 741025 <sup>C</sup>	SM5303 SM5303			SB103 SB103	SB107 SB107
1984-85	GSL-SE			343140		KG4644A					SB103	
1981-85	ALL (Exc. GSL-SE)		363010	343140		KG4644A		SM5304			SB103	
1979-80	ALL		363003	343140		KG4644A						

## MAZDA RX-8

2004-10	Strut / Shock Boot										SB101	SB107
2004-06	ALL (Exc. SHINKA Package)			551115	551116							

## MAZDA Tribute

2009-10	ALL	Right Hand Left Hand	235912 235913					SM5390 SM5390			SB105 SB105	
	Upper Spring Seat Insulator								SM5547			
2001-08	ALL	Right Hand Left Hand	235912 235913	344356 344356				SM5390 SM5390			SB105 SB105	
	Upper Spring Seat Insulator								SM5547			

## MERCEDES BENZ 190 Series

1989-93	190E, 190D, 190 (W201)		235021			553177 <sup>76</sup>			SM5084		SB119	
1984-88	190E (W201) 2.3L 16 Valve 190E, 190D, 190 (W201) (Exc. 2.3L 16 Valve)		235021 235021			553178 553177 <sup>76</sup>			SM5084 SM5084		SB102 SB102	
1961-65	190c, 190Dc (W110) 190c, 190Dc Station Wagon				KG4523 KG4523	KG5534						

## MERCEDES BENZ 200 Series

1985-93	200T, 200TD (W124) Station Wagon		235021						SM5084		SB119	
1984-93	200, 200D (W124)		235021			553178			SM5084		SB119	
1978-85	200T (W123) Station Wagon				KG4530							
1976-84	200, 200D (W123)				KG4530	KG5554						
1968-76	200, 200D (W115) (W114)				KG4522	KG5533						
1965-67	200, 200D (W111) 200, 200D Station Wagon				KG4523 KG4523	KG5534						

<sup>76</sup> Replaces [KG4548], when stock is depleted











<sup>C</sup> To convert from Electronic Susp. - See Appendix C

Notes de bas de Page 320 - Guia de notas al calce del catalogo Pg. 321

Bold part numbers indicate the most comparable KYB product to the original design & performance.

(22) For vehicles with Electronic Susp., Leveling Control, and Air Suspensions refer to Appendix C.

# Applications For Pass. Cars, Light Trucks, SUV's, & Vans

VEHICLE MAKE, MODEL & YEAR	  		
MARQUE, MODELE ET			
ANNEE DU VEHICULE			
LA MARCA EL MODELO & AÑO			
	    		

## MERCEDES BENZ 220 Series

1976-84	220D (W123)			KG4530	KG5554					
1968-78	220, 220D (W115) Station Wagon			KG4522	KG5554					
1968-76	220, 220D (W115) (W114)			KG4522	KG5533					
1961-65	220b, 220Sb Station Wagon			KG4523						
1960-65	220Sb, 220SE, 220SEb (W111) (Exc. Hydromat Susp.)			KG4523	KG5534					
	220b (W111)			KG4523	KG5534					

## MERCEDES BENZ 230 Series

1987-93	230CE (C124)	235021			553178			SM5084		SB102
1985-93	230TE (W124) Station Wagon	235021						SM5084		SB119
1984-93	230E (W124)	235021			553178			SM5084		SB119
1978-85	230T, 230TD (W123) Station Wagon			KG4530						
1976-84	230 (W123)			KG4530	KG5554					
	230C, 230CE (C123)			KG4530	KG5554					
1973-76	230-4 (W115) Station Wagon			KG4522						
1968-76	230 (W115) (W114)			KG4522	KG5533					
1965-67	230, 230S (W111)			KG4523	KG5534					
	230, 230S Station Wagon			KG4523						
1963-66	230SL (W113)			KG4523	KG5534					

## MERCEDES BENZ 240 Series

1977-84	240D (W123)			KG4530	KG5554					
1974-76	240D (W115)			KG4522	KG5533					

## MERCEDES BENZ 250 Series

1985-93	250TD (W124) Station Wagon	235021						SM5084		SB119
1984-93	250D (W124)	235021			553178			SM5084		SB119
1978-85	250T (W123) Station Wagon			KG4530						
1976-84	250 (W123)			KG4530	KG5554					
1973-76	250C, 250CE (W114)			KG4522	KG5533					
1968-76	250 (W114)			KG4522	KG5533					
1968-8/72	250S (Exc. Hydromat Susp.)			KG4523	KG5534					
1967-81	250SL (W113)			KG4523	KG5534					
1965-67	250S, 250SE (Exc. Hydromat Susp.)			KG4523	KG5534					

## MERCEDES BENZ 260 Series

1986-93	260E 4Matic				553178					
1985-91	260SE (W126) (Exc. Hydromat Susp.)			KG4530	KG5554					
1984-93	260E (W124) (Exc. 4Matic)	235021			553178			SM5084		SB119











## MERCEDES BENZ 280 Series

1980-85	280S, 280SE, 280SEL (W126) (Exc. Hydromat Susp.)			KG4530	KG5554					
1978-85	280TE (W123) Station Wagon			KG4530						
1976-84	280, 280E (W123)			KG4530	KG5554					
	280C, 280CE (C123)			KG4530	KG5554					
1974-85	280SL, 280SLC (W107)			KG4523	KG5554					

Notes de bas de Page 320 - Guia de notas al calce del catalogo Pg. 321

Bold part numbers indicate the most comparable KYB product to the original design & performance.  
(22) For vehicles with Electronic Susp., Leveling Control, and Air Suspensions refer to Appendix C.

# Applications For Pass. Cars, Light Trucks, SUV's, & Vans

VEHICLE MAKE, MODEL & YEAR	  	STRUT & SHOCK		BOOT KITS	
MARQUE, MODELE ET		MOUNTS			
ANNEE DU VEHICULE					
LA MARCA EL MODELO & AÑO					
	 	 	 	 	 

## MERCEDES BENZ 280 Series (continued)

1973-76	280C, 280CE (W115) 280E (W115)			KG4522 KG4522	KG5533 KG5533						
9/72-80	280S, 280SE, 280SEL (W116) (Exc. Hydromat Susp.)			KG4530	KG5554						
1968-8/72	280S, 280SE, 280SEL (W108) (Exc. Hydromat Susp.)			KG4523	KG5534						
1968-71	280SL (W113)			KG4523	KG5534						

## MERCEDES BENZ 300 Series

1991-93	300SD, 300SE, 300SEL (W140) Sedan			553606	553178						
1987-93	300CE (C124)	235021			553178			SM5084			SB102
1986-93	300E, 300D (W124) 4Matic				553178						SB119
1985-93	300TE, 300TD (W124) Station Wagon (Exc. 4Matic)	235021						SM5084			SB119
1985-89	300SL (W107)			KG4522	KG5554						
1984-93	300E, 300D (W124) (Exc. 4Matic)	235021			553178			SM5084			SB119
1981-91	300SD, 300SDL, 300SE, 300SEL (W126) (Exc. Hydromat Susp.)			KG4530	KG5533						
1978-85	300TD (W123) Station Wagon			KG4530							
1976-85	300D, 300CD, 300CDT (W123)			KG4530	KG5554						
1975	300D (W115)			KG4522	KG5533						
9/72-80	300SD (W116)			KG4530	KG5554						
1965-8/72	300SE, 300SEL, 300SEb (W109) (Exc. Hydromat Susp.)				KG5534						

## MERCEDES BENZ 350 Series

1991-93	350S (W140) Sedan			553606	KG5533						
1985-91	350S (W126) Sedan			KG4530	KG5533						
9/72-80	350SE (W126) (Exc. Hydromat Susp.)			KG4530	KG5554						
1971-81	350SL, 350SLC, 350SL-4.5, 350SLC-4.5 (W107)			KG4522	KG5554						

## MERCEDES BENZ 380 Series

1981-85	380SEC (W126) (Exc. Hydromat Susp.) 380SL, 380SLC (W107)			KG4530	KG5554						
1980-85	380SE, 380SEL, (W126) (Exc. Hydromat Susp.)			KG4522	KG5554						
				KG4530	KG5554						

## MERCEDES BENZ 400 Series







1992-93	400SE, 400SEL (W140) Sedan 400E (W124) Sedan			553606	553178 553178			SM5084			SB119
---------	---	--	--	--------	------------------	--	--	--------	--	--	-------

## MERCEDES BENZ 420 Series

1985-92	420SEC (C126) (Exc. Hydromat Susp.)			KG4530	KG5554						
1985-91	420SE, 420SEL (W126) (Exc. Hydromat Susp.)			KG4530	KG5554						
1985-89	420SL (W107)			KG4522	KG5554						

Notes de bas de Page 320 - Guia de notas al calce del catalogo Pg. 321  
 Bold part numbers indicate the most comparable KYB product to the original design & performance.  
 (22) For vehicles with Electronic Susp., Leveling Control, and Air Suspensions refer to Appendix C.

# Applications For Pass. Cars, Light Trucks, SUV's, & Vans

VEHICLE MAKE, MODEL & YEAR	<b>GR-2</b>	<b>Gas-a-Just</b>	<b>MonoMax</b> 56XXX Series	STRUT & SHOCK	
MARQUE, MODELE ET	<b>Excel-G</b>		<b>AGX</b> 7XXX Series	MOUNTS	BOOT KITS
ANNEE DU VEHICULE	 	 	 	 	 
LA MARCA EL MODELO & AÑO					

## MERCEDES BENZ 450 Series

1974-81	450SL, 450SLC, 450SLC-4.5 (W107)			KG4522	KG5554					
3/73-80	450SE, 450SEL, 450SEL-6.9 (W116) (Exc. Hydromat Susp.)			KG4530	KG5554					

## MERCEDES BENZ 500 Series

1993	500SEC (C140) Coupe			553606						
1991-93	500SE, 500SEL (W140) Sedan			553606	553178					
1980-92	500SEC (W126) (C126) (Exc. Hydromat Susp.)			KG4530	KG5554					
1980-91	500SE, 500SEL (W126) (Exc. Hydromat Susp.)			KG4530	KG5554					
1980-89	500SL (W107)			KG4522	KG5554					

## MERCEDES BENZ 560 Series

1985-92	560SEL (W126), 560SEC (C126) (Exc. Hydromat Susp.)			KG4530	KG5554					
9/85-90	560SL (R107)				KG5554					

## MERCEDES BENZ 600 Series

1993	600SEC (C140) Coupe 600SEL (W140) Sedan			553606 553606	553178					
------	--	--	--	------------------	--------	--	--	--	--	--

## MERCEDES BENZ C Class (Exc. 4 Matic)

2006-07	C280 (W203) C350 (W203)	335920 335920								
2002-05	C230 (CL203) Coupe (Exc. Sport Susp.) C230 (CL203) Coupe w/ Sport Susp. C240, C320 (S203) Wagon Coupe	335920 335920 335920			553605 <sup>70</sup> 553306					SB105
2001-06	C Class (W203) (Exc. Self Leveling)	335920			553306					
2001-05	C320 (W203) Sedan	335920			553306					
1997-3/01	C230 (W202) w/ Sport Susp. (Exc. Self Leveling) C230 (W202) w/o Sport Susp. (Exc. Self Leveling)			KG4729 KG4739	KG4728 KG4740					
1993-00	C220 (W202) w/ Sport Susp. (Exc. Self Leveling) C220 (W202) w/o Sport Susp. (Exc. Self Leveling) C280 (W202) (Exc. Self Leveling)			KG4729 KG4739 KG4739	KG4728 KG4740 KG4740					

## MERCEDES BENZ CLK Class

2007-09	CLK550 Convertible CLK550 Coupe	335932 <sup>70</sup> 335920			553367 553366					SB105 SB105
2006-09	CLK350 (Exc. Sport Suspension) CLK350 w/ Sport Suspension	335920 335932 <sup>70</sup>			553366 553367					SB105 SB105
2006	CLK500									SB105
2004-05	CLK320 & CLK500	335920								SB105
2003-06	CLK55 AMG Convertible CLK55 AMG Coupe	335932 <sup>70</sup> 335920			553367 553366					SB101 SB101
2003	CLK320 w/ Sport Suspension	335932 <sup>70</sup>			553367					
1999-03	CLK430			KG4731	KG4740					

<sup>70</sup> New Part Number, Available 2nd Quarter 2011

Notes de bas de Page 320 - Guia de notas al calce del catalogo Pg. 321  
 Bold part numbers indicate the most comparable KYB product to the original design & performance.  
 (22) For vehicles with Electronic Susp., Leveling Control, and Air Suspensions refer to Appendix C.

# Applications For Pass. Cars, Light Trucks, SUV's, & Vans

VEHICLE MAKE, MODEL & YEAR	<b>GR-2</b>	<b>Gas-a-Just</b>	<b>MonoMax</b> 56XXXX Series	STRUT & SHOCK	
MARQUE, MODELE ET	<b>Excel-G</b>		<b>AGX</b> 7XXXXX Series	MOUNTS	BOOT KITS
ANNEE DU VEHICULE					
LA MARCA EL MODELO & AÑO					

## MERCEDES BENZ CLK Class (continued)

1998-02	CLK320 (Exc. Sport Susp.)			KG4731	KG4740					
---------	---------------------------	--	--	--------	--------	--	--	--	--	--

## MERCEDES BENZ E Class

2006-09	E350 Sedan 4Matic (Exc. Air Susp. and CDI) E350 Sedan RWD (Exc. Air Susp.)				553380					
					553356					
2004-05	E320 Sedan 4Matic (Exc. Air Susp. and CDI)				553380					
2003-09	E320 Sedan RWD (Exc. Air Susp.) ALL (211) w/o Air Susp., w/ Sport ALL (211) w/o Air Susp., w/o Sport				553356				SB129 SB101	
1998-02	E320 (W210) Wagon (Exc. 4Matic) E430 (W210) (Exc. 4Matic & Sport Susp.) E430 (W210) w/ Sport Susp. (Exc. 4Matic)			KG4727 KG4742	KG4743					
				KG4727	KG4726					
1997	E420 (W210) (Exc. Self Leveling & Sport Susp.) E420 (W210) w/ Sport Susp. (Exc. Self Leveling)			KG4742	KG4743					
				KG4727	KG4726					
1996-02	E320 (W210) Sedan (Exc. 4Matic & Self Leveling)			KG4742	KG4743					
1996-99	E300D W210 (Exc. Rear Level Control)			KG4742	KG4743					
1993-95	E300D, E320, E420 (W124) 4 Door (Exc. Rear Level Control)	235021			553178			SM5084		SB102
	E320 (S124) Station Wagon	235021						SM5084		SB102
	E320, E420 (V124) w/ Rear Level Control	235021						SM5084		SB102
	E320c (C124) 2 Door	235021			553178			SM5084		SB102
	E500 (W124)	235021						SM5084		SB102
	E320 (A124) Convertible				553178					

## MERCEDES BENZ ML55 AMG

2002-03	ALL	349055								
2000-01	ALL	349055								

## MERCEDES BENZ ML320

2001-03	ALL	349055								
1998-00	ALL	349055								

## MERCEDES BENZ ML350

2003-05	ALL	349055								
---------	-----	--------	--	--	--	--	--	--	--	--

## MERCEDES BENZ ML430

1999-01	ALL	349055								
---------	-----	--------	--	--	--	--	--	--	--	--

## MERCEDES BENZ ML500

2002-05	ALL	349055								
---------	-----	--------	--	--	--	--	--	--	--	--











## MERCEDES BENZ S Class

1994-99	S320, S350D, S420, S500, S600 (W140) Sedan (Exc. Rear Level Control or w/ Active Damping System)			553606	553178					
	S500, S600 (C140) Coupe (Exc. w/ Rear Level Control or Adaptive Damping System)			553606	553178					

Notes de bas de Page 320 - Guia de notas al calce del catalogo Pg. 321

Bold part numbers indicate the most comparable KYB product to the original design & performance.  
(22) For vehicles with Electronic Susp., Leveling Control, and Air Suspensions refer to Appendix C.

# Applications For Pass. Cars, Light Trucks, SUV's, & Vans

VEHICLE MAKE, MODEL & YEAR	<i><b>GR-2</b></i> <i><b>Excel-G</b></i>	<i><b>Gas-a-Just</b></i>	<i><b>MonoMax</b></i> 56XXXX Series <i><b>AGX</b></i> 7XXXXX Series	STRUT & SHOCK MOUNTS	BOOT KITS
MARQUE, MODELE ET ANNEE DU VEHICULE	 	 	 	 	 
LA MARCA EL MODELO & AÑO					

## MERCEDES BENZ S Class (continued)

1993-99	S320, S420, S500 (V140) Sedan w/ Rear Level Control			553606						
---------	--	--	--	--------	--	--	--	--	--	--

## MERCEDES BENZ SL Class

1990-02	ALL SL129 Chassis- 300SL, 500SL, 600SL, SL320, SL600 w/ self leveling			NA	NA			SM5309		
---------	--	--	--	----	----	--	--	--------	--	--

## MERCEDES BENZ SLK Class

1997-04	SLK230 & SLK320			KG4731	KG4732					
---------	-----------------	--	--	--------	--------	--	--	--	--	--

## MERCEDES BENZ Sprinter 2500

2002-06	ALL (Exc. 118" WB, High Roof Option, Chassis Cab)	335810	349001					SM5445		
	ALL w/ 118" WB & High Roof Option	335809	341339					SM5445		
	ALL w/ 118" WB (Exc. High Roof Option)	335810	341339					SM5445		
	ALL w/ High Roof Option or Chassis Cab (Exc. 118" WB)	335809	349001					SM5445		

## MERCEDES BENZ Sprinter 3500

2002-06	ALL (Exc. High Roof Option, Dual Rear Wheels, Chassis Cab)	335810	349001					SM5445		
	ALL w/ Dual Rear Wheels & High Roof Option or Chassis Cab	335809	344409					SM5445		
	ALL w/ Dual Rear Wheels (Exc. High Roof Option, Chassis Cab)	335810	344409					SM5445		
	ALL w/ High Roof Option or Chassis Cab (Exc. Dual Rear Wheels)	335809	349001					SM5445		

## MERCURY Bobcat

1975-80	Sedan, Coupe & Hatchback Station Wagon	343134 343134	343137	KG4511 KG4511	KG5514					
---------	---	------------------	--------	------------------	--------	--	--	--	--	--

## MERCURY Capri

1991-94	ALL Right Hand Left Hand	234008 234009						SM5141 SM5141	SM5045 SM5045	SB105 SB105	SB103 SB103
1984-86	AXLE DAMPER (Rear Quad Shock)				KG4521 <sup>23</sup>						
1983-86	ALL (Exc. Special Handling) w/ Special Handling Pkg.	235005 235005	343163 343161		KG5559 KG5551			SM5036 SM5036		SB103 SB103	
1982	ALL		343163		KG5559					SB103	
1979-81	ALL	235001	343161		KG5551					SB103	
1971-78	ALL Shock (Sleeve) Adapter Kit		343135 <sup>7</sup> KIT107							SB101	

## MERCURY Comet

1971-77	ALL	343146	343136	KG4517							
1966-70	Sedan & Coupe Station Wagon	343156 343156	343219 343135	KG4505 KG4505	KG5517						
1960-65	ALL	343156	343219	KG4505	KG5517						













## MERCURY Cougar

1999-02	ALL	235620	235621					SM5138		SB105	SB102
1999-00	Strut / Shock Mount								SM5140		
1989-97	ALL (Exc. Adjustable Susp.)	231015	344110					SM5187			

<sup>23</sup> Install [KG4521] with the dustcover to the rear of the vehicle, the spacers (in box) to the inboard side of the shock, and the axle mounting bracket spread slightly (1-2mm).  
<sup>7</sup> Use Kit #107



# Applications For Pass. Cars, Light Trucks, SUV's, & Vans

VEHICLE MAKE, MODEL & YEAR	  	STRUT & SHOCK		BOOT KITS	
MARQUE, MODELE ET		MOUNTS			
ANNEE DU VEHICULE					
LA MARCA EL MODELO & AÑO					
	 	 	 	 	 

## MERCURY Cougar (continued)

1989-97	ALL (Exc. XR-7) Lower Spring Seat Insulator							SM5465			
1987-88	ALL (Exc. Turbo) XR7 (For Adapting PRC to Non-PRC Suspension)	235005 235008 <sup>c</sup>	343162			KG5556 KG5556 <sup>c</sup>		SM5054 SM5054		SB103 SB103	
1984-88	AXLE DAMPER (Rear Quad Shock)					KG4521 <sup>23</sup>					
1983-86	ALL	235002	343162			KG5556		SM5054		SB103	
1981-82	ALL (Exc. XR-7)	235005	343163			KG5559		SM5036		SB103	
12/80-82	XR-7	235002	343162			KG5556		SM5054		SB103	
1974-79	ALL	343128	343135	KG4515	KG5521						
1971-73	ALL	343156	343219	KG4504	KG5517						
1967-70	ALL	343146	343219	KG4517	KG5517						

## MERCURY Colony Park

1969-74	ALL	343128	343149			KG5522					
1965-68	ALL	343128	343149			KG5522					
1961-64	ALL	343127	343136								
1957-60	ALL	343127	343219			KG5517					

## MERCURY Cyclone

1972-76	ALL	343128	343135	KG4515	KG5521						
1968-71	ALL (Exc. Station Wagon) Station Wagon	343156 343156	343219 343135	KG4505 KG4505	KG5517						

## MERCURY Grand Marquis

2003-08	ALL (Incl. Rear Air Spring Susp.)			551600	555601 <sup>59</sup>			SM5392	SM5267		
2000-02	Police Car & Taxi	344081 <sup>32</sup>	343135	KG5458 <sup>32</sup>	KG5521						
1995-02	ALL (Exc. Police Car & Taxi)	344424	343135	KG5572	KG5521						
1983-99	Police Car & Taxi	344081	343135	KG5458	KG5521						
1983-94	ALL (Exc. Police Car & Taxi)	343128	343135	KG4515	KG5521						
1979-82	ALL	343128	343135	KG4515	KG5521						
1975-78	ALL	343128	343149	KG4515	KG5522						

## MERCURY Lynx, LN7

3/1/85-88	ALL Strut Mount Bearing	333141	231002					SM5037 SM5006	SM5269	SB101	SB103
1983-85	ALL (Built 2/1/83 thru 3/1/85)	234018	231002					SM5268	SM5269	SB101	SB103
1981-2/1/83	ALL		231002					SM5268	SM5269	SB101	SB103

## MERCURY Marauder

2003-06	ALL			551602	555603 <sup>59</sup>			SM5392	SM5267		
---------	-----	--	--	--------	----------------------	--	--	--------	--------	--	--

## MERCURY Mariner

2008-10	ALL	Right Hand Left Hand	235912 235913	349101 <sup>70</sup> 349101 <sup>70</sup>				SM5390 SM5390		SB105 SB105	
2005-07	ALL	Right Hand Left Hand	235912 235913	344356 344356				SM5390 SM5390		SB105 SB105	
2005-10	Upper Spring Seat Insulator								SM5547		

<sup>23</sup> Install [KG4521] with the dustcover to the rear of the vehicle, the spacers (in box) to the inboard side of the shock, and the axle mounting bracket spread slightly (1-2mm).

<sup>32</sup> bushing kit C0522 required with [KG5458] on Police / Taxi

<sup>59</sup> Mount kit [SM5267] required with [555601], or [555603]

<sup>70</sup> New Part Number, Available 2nd Quarter 2011

<sup>c</sup> To convert from Electronic Susp. - See Appendix C

# Applications For Pass. Cars, Light Trucks, SUV's, & Vans

VEHICLE MAKE, MODEL & YEAR	<b>GR-2</b>		<b>Gas-a-Just</b>		<b>MonoMax</b> 56XXXX Series		STRUT & SHOCK			
MARQUE, MODELE ET	<b>Excel-G</b>				<b>AGX</b> 7XXXX Series		MOUNTS		BOOT KITS	
ANNEE DU VEHICULE										
LA MARCA EL MODELO & AÑO										

## MERCURY Marquis

1983-86	ALL		235005	343163		KG5559			SM5036		SB103	
1979-82	ALL		343128	343135	KG4515	KG5521						
1967-78	ALL		343128	343149	KG4515	KG5522						

## MERCURY Milan (AWD)

2010	ALL Mount & Spring Seat w/ Insulator			344363					SM5540		SB101	
2007-09	ALL Right Hand	341405	349033								SB101	
	ALL Left Hand Mount & Spring Seat w/ Insulator	341406	349033						SM5540		SB101	

## MERCURY Milan (FWD)

2010	ALL (Exc. Sport Susp.) Mount & Spring Seat w/ Insulator			344363					SM5540		SB101	
2006-09	ALL Right Hand	341405	344363								SB101	
	ALL Left Hand Mount & Spring Seat w/ Insulator	341406	344363						SM5540		SB101	

## MERCURY Monarch

1975-80	ALL		343133	343136								
---------	-----	--	--------	--------	--	--	--	--	--	--	--	--

## MERCURY Montclair

1965-68	ALL		343128	343149		KG5522						
1964	ALL		343127	343136								
1959-60	ALL		343128	343219								
1957-58	ALL		343127									

## MERCURY Montego (Exc. Self Leveling Rear Susp.)

12/5/05-07	AWD Right Hand	334638	341462									
	AWD Left Hand	334639	341462									
2005-07	FWD Right Hand	334640	341472									
	FWD Left Hand	334641	341473									
05-12/4/05	AWD Right Hand	334638										
	AWD Left Hand	334639										
1972-76	ALL		343128	343135	KG4515	KG5521						
1968-71	ALL (Exc. Station Wagon)	343156	343219	KG4505	KG5517							
	Station Wagon	343156	343135	KG4505								

## MERCURY Monterey (Car)

1965-74	ALL		343128	343149		KG5522						
1961-64	ALL		343127	343136								
1959-60	ALL		343127	343219		KG5517						
1957-58	ALL		343127									

## MERCURY Monterey (Van)

2004-07	ALL Mount, Spring Seat & Bearing Lower Spring Seat Insulator		235921	344467					SM5448 SM5463		SB130	
---------	--	--	--------	--------	--	--	--	--	------------------	--	-------	--

Notes de bas de Page 320 - Guia de notas al calce del catalogo Pg. 321  
 Bold part numbers indicate the most comparable KYB product to the original design & performance.  
 (2) For vehicles with Electronic Susp., Leveling Control, and Air Suspensions refer to Appendix C.

# Applications For Pass. Cars, Light Trucks, SUV's, & Vans

VEHICLE MAKE, MODEL & YEAR										
MARQUE, MODELE ET	<b>GR-2</b>		<b>Gas-a-Just</b>		<b>MonoMax</b> 56XXXX Series		STRUT & SHOCK			
ANNEE DU VEHICULE	<b>Excel-G</b>				<b>AGX</b> 7XXXXX Series		MOUNTS		BOOT KITS	
LA MARCA EL MODELO & AÑO										

## MERCURY Mountaineer

2006-10	ALL		341474	341475								
2006-09	Upper Spring Seat Insulator								SM5520			
2004-05	ALL		341419 <sup>61</sup>	341327 <sup>61</sup>					SM5391	SM5391		
	Upper Spring Seat Insulator								SM5519			
2002-03	ALL		341326 <sup>61</sup>	341327 <sup>61</sup>					SM5391	SM5391		
	Upper Spring Seat Insulator								SM5518			
1997-01	ALL (Exc. Electronic Adj. Susp.) AXLE DAMPER (Rear Quad Shock)		341302	344269 SS10201	KG54309	KG5490	561001	565003				

## MERCURY Mystique

3/97-00	ALL		235620	235621					SM5138	SM5140	SB105	
1995-2/97	ALL		235910	235911					SM5138	SM5140	SB105	

## MERCURY Sable (also see STRUT-PLUS)

2009	AWD FWD	Right Hand Left Hand		341462 340012 340013								
2008	AWD FWD	Right Hand Left Hand Right Hand Left Hand	334652 <sup>70</sup> 334653 <sup>70</sup> 334652 <sup>70</sup> 334653 <sup>70</sup>	341462 341462 340012 340013								
2000-05	Sedan Station Wagon Upper Spring Seat Upper Spring Seat Insulator (Wagon) Lower Spring Seat Insulator (Wagon) Lower Spring Seat Insulator	Right Hand Left Hand Right Hand Left Hand	334292 334293 334292 334293	334294 334294 344434 344434		KG5575 KG5575			SM5113 SM5113 SM5113 SM5113 SM5227 SM5466	SM5055 SM5055 SM5267 SM5267 SM5551 SM5551	SB103 SB103	SB101 SB101
1996-99	Sedan Station Wagon Upper Spring Seat Upper Spring Seat Insulator (Wagon) Lower Spring Seat Insulator (Wagon) Lower Spring Seat Insulator		334168 334168	334169 344432		KG5574			SM5113 SM5113 SM5227 SM5466	SM5055 SM5267 SM5551 SM5551	SB103 SB103	SB103
1991-95	Sedan Lower Spring Seat Insulator		235054	334325					SM5038 SM5415	SM5055 SM5414	SB103	SB103
1988-95	Lower Spring Seat Insulator								SM5415			
1986-95	Station Wagon Strut Mount & Bearing Strut Mount Bearing Upper Spring Seat		235054	344271		KG5567			SM5038 SM5271 SM5005 SM5156	SM5267	SB103	
1986-90	ALL (Exc. Station Wagon) Strut Mount (Adjustable) Upper Spring Seat Insulator		235054	334325					SM5038 SM5272	SM5015 SM5235	SB103	SB103

## MERCURY Sable - STRUT-PLUS

2000-06	Sedan Station Wagon	Right Hand Left Hand Right Hand Left Hand	SR4009 SR4010 SR4009 SR4010	SR4011 SR4011								
1996-99	Sedan Station Wagon		SR4033 SR4033	SR4034								
1991-95	Sedan		SR4017	SR4018								
1986-95	Station Wagon		SR4017									

<sup>61</sup> [SM5391] may be required to replace original bushings in mount

<sup>70</sup> New Part Number, Available 2nd Quarter 2011

Notes de bas de Page 320 - Guia de notas al calce del catalogo Pg. 321

Bold part numbers indicate the most comparable KYB product to the original design & performance.

(22) For vehicles with Electronic Susp., Leveling Control, and Air Suspensions refer to Appendix C.

# Applications For Pass. Cars, Light Trucks, SUV's, & Vans

VEHICLE MAKE, MODEL & YEAR	<b>GR-2</b>		<b>Gas-a-Just</b>		<b>MonoMax</b> 56XXXX Series		STRUT & SHOCK			
MARQUE, MODELE ET	<b>Excel-G</b>				<b>AGX</b>		MOUNTS		BOOT KITS	
ANNEE DU VEHICULE					7XXXXX Series					
LA MARCA EL MODELO & AÑO										

## MERCURY Sable - STRUT-PLUS (continued)

1986-90	Sedan		SR4017	SR4018							
---------	-------	--	--------	--------	--	--	--	--	--	--	--

## MERCURY Topaz

1987-91	AWD		333141					SM5037	SM5014	SB103	SB103
3/1/85-94	ALL FWD		333141	234016				SM5037	SM5014	SB103	SB103
1984-3/1/85	ALL		234015	234016				SM5037	SM5014	SB101	SB103
1984-94	Front Strut Mounting Kit Strut Mount Bearing Upper Spring Seat Insulator							SM5270 SM5006	SM5347		

## MERCURY Tracer (Canadian Vehicle)

1987	Sedan & Hatchback	Right Hand	234008	232011				SM5039	SM5045	SB102	SB102
		Left Hand	234009	232012				SM5039	SM5045	SB102	SB102
	Station Wagon	Right Hand	234008					SM5039	SM5045	SB102	SB102
		Left Hand	234009					SM5039	SM5045	SB102	SB102

## MERCURY Tracer (also see STRUT-PLUS)

1997-99	ALL (Exc. ABS)	Right Hand	235914	234903				SM5044	SM5046	SB105	SB104
		Left Hand	235915	234904				SM5044	SM5046	SB105	SB104
1991-99	Strut Mount w/ Bearing Upper Spring Seat Spring Seat Insulator							SM5170 SM5155	SM5430		
1991-96	FWD (Exc. ABS)	Right Hand	234037	234039				SM5044	SM5046	SB101	SB102
		Left Hand	234038	234040				SM5044	SM5046	SB101	SB102
1988-90	Sedan & Hatchback	Right Hand	234008	232011				SM5039	SM5045	SB102	SB102
		Left Hand	234009	232012				SM5039	SM5045	SB102	SB102
	Station Wagon	Right Hand	234008					SM5039	SM5045	SB102	SB102
		Left Hand	234009					SM5039	SM5045	SB102	SB102

## MERCURY Tracer - STRUT-PLUS

1997-99	ALL (Exc. ABS)	Right Hand	SR4012	SR4014							
		Left Hand	SR4013	SR4015							
1991-96	ALL (Exc. ABS & 4WD)	Right Hand	SR4005	SR4007							
		Left Hand	SR4006	SR4008							

## MERCURY Villager Mini-Van

1999-02	ALL	Right Hand	334321	344055		KG5538		565065	SM5098		SB101
		Left Hand	334322	344055		KG5538		565065	SM5098		SB101
	Strut Mount w/ Bearing Strut Mount Bearing Upper Spring Seat Lower Spring Seat Insulator								SM5326 SM5064 SM5554 SM5521		
1993-98	ALL	Right Hand	235058	344055		KG5538		565065	SM5098		SB101
		Left Hand	235059	344055		KG5538		565065	SM5098		SB101
	Strut Mount w/ Bearing Strut Mount Bearing Upper Spring Seat Lower Spring Seat Insulator								SM5326 SM5064 SM5554 SM5521		

## MERCURY Zephyr

1983	ALL		235005	343163		KG5559			SM5036		SB103
1982	ALL (Exc. TRX Susp.)		235001	343163		KG5559			SM5036		SB103
1981-82	ALL w/ TRX Susp.		235005	343163		KG5559			SM5036		SB103
1978-81	ALL (Exc. TRX Susp.)		235001	343161		KG5551					SB103

Notes de bas de Page 320 - Guia de notas al calce del catalogo Pg. 321

Bold part numbers indicate the most comparable KYB product to the original design & performance.  
(2) For vehicles with Electronic Susp., Leveling Control, and Air Suspensions refer to Appendix C.

# Applications For Pass. Cars, Light Trucks, SUV's, & Vans

VEHICLE MAKE, MODEL & YEAR	<b>GR-2</b>		<b>Gas-a-Just</b>		<b>MonoMax</b> 56XXXX Series		STRUT & SHOCK			
MARQUE, MODELE ET	<b>Excel-G</b>				<b>AGX</b> 7XXXXX Series		MOUNTS		BOOT KITS	
ANNEE DU VEHICULE										
LA MARCA EL MODELO & AÑO										

## MERKUR Scorpio

1987-89	ALL		235022			KG4546					SB101	
---------	-----	--	--------	--	--	--------	--	--	--	--	-------	--

## MERKUR XR4Ti

1985-89	ALL		234026			KG4545					SB101	
---------	-----	--	--------	--	--	--------	--	--	--	--	-------	--

## MINI Cooper

2007-08	ALL	Right Hand	334621	341924						SM5444		
		Left Hand	334622	341924						SM5444		
3/02-06	ALL Coupe	Right Hand	334621	341924					SM5443	SM5444	SB103	
		Left Hand	334622	341924					SM5443	SM5444	SB103	SB108

## MITSUBISHI 3000GT

1991-99	ALL (Exc. Adjustable Susp. & VR4) FWD (For Adapting ECS to Non-ECS Suspension) VR4 Model w/o Adjustable Susp.		335013	341183					SM5096	SM5091	SB101	SB108
			335013 <sup>c</sup>	341184 <sup>c</sup>					SM5096	SM5091	SB101	SB108
			335013						SM5096	SM5091	SB101	SB108
1991-95	AWD (For Adapting ECS to Non-ECS Suspension)		335013 <sup>c</sup>	341185 <sup>c</sup>					SM5096	SM5091	SB101	SB108

## MITSUBISHI Cordia

1983-88	ALL		235006			KG4192					SB103	
---------	-----	--	--------	--	--	--------	--	--	--	--	-------	--

## MITSUBISHI Diamante

2004	ALL		NA	NA								
2001-03	ALL	Right Hand	334271	341274					SM5295	SM5460	SB101	SB101
		Left Hand	334272	341274					SM5295	SM5460	SB101	SB101
1997-00	ALL	Right Hand	334271	341274					SM5194	SM5460	SB101	SB101
		Left Hand	334272	341274					SM5194	SM5460	SB101	SB101
1993-96	Station Wagon (Exc. Adj. Damping/Air Height System)		236008						SM5194		SB101	SB108
1992-96	Sedan (Exc. Adj. Damping/Air Height System)		236008	341134					SM5194		SB101	SB108

## MITSUBISHI Eclipse

2010	ALL w/ 4 Cyl. Engine	Right Hand	339041	341404								
		Left Hand	339042	341404								
	ALL w/ 6 Cyl. Engine	Right Hand	335057	341404								
		Left Hand	335058	341404								
2006-09	ALL w/ 4 Cyl. Engine	Right Hand	339041	341404						SM5460	SB101	SB101
		Left Hand	339042	341404						SM5460	SB101	SB101
	ALL w/ 6 Cyl. Engine	Right Hand	335057	341404						SM5460	SB101	SB101
		Left Hand	335058	341404						SM5460	SB101	SB101
	Strut Mount & Bearing							SM5541				
2000-05	ALL	Right Hand	334267	341164			734019	741020	SM5388	SM5091	SB103	SB103
		Left Hand	334268	341164			734020	741020	SM5388	SM5091	SB103	SB103
	Upper Spring Seat Insulator								SM5433			
1995-99	AWD FWD		341163	341164			741042	741020	SM5091	SM5091	SB103	SB103
		Upper Spring Seat Insulator	341163	341165			741042	741019	SM5091	SM5091	SB103	SB103
1990-94	AWD FWD		235032	341121			734005	741014	SM5072	SM5091	SB101	SB108
			235032	341114			734005	741013	SM5072	SM5091	SB101	SB108





<sup>c</sup> To convert from Electronic Susp - See Appendix C

Notes de bas de Page 320 - Guia de notas al calce del catalogo Pg. 321

Bold part numbers indicate the most comparable KYB product to the original design & performance.

(22) For vehicles with Electronic Susp., Leveling Control, and Air Suspensions refer to Appendix C.

# Applications For Pass. Cars, Light Trucks, SUV's, & Vans

VEHICLE MAKE, MODEL & YEAR		<b>GR-2</b>		<b>Gas-a-Just</b>		<b>MonoMax</b> 56XXXX Series		STRUT & SHOCK			
MARQUE, MODELE ET		<b>Excel-G</b>				<b>AGX</b> 7XXXXX Series		MOUNTS		BOOT KITS	
ANNEE DU VEHICULE											
LA MARCA EL MODELO & AÑO											

## MITSUBISHI Endeavor

2004-08	ALL Strut Mount & Bearing	NA	NA					SM5541		SB102	SB102
---------	------------------------------	----	----	--	--	--	--	--------	--	-------	-------

## MITSUBISHI Expo & Expo LRV

1992-96	Wagon 2WD	235032	343262			734005		SM5195	SM5091	SB101	SB108
---------	-----------	--------	--------	--	--	--------	--	--------	--------	-------	-------

## MITSUBISHI Galant (Exc. Adj. Suspensions)

2009-10	ES & SE Models	Right Hand Left Hand	334432 334433	341373 341373							
2009	Strut / Shock Boot									SB101	SB101
2004-09	Strut Mount & Bearing							SM5541			
2004-08	DE, ES & SE Models	Right Hand Left Hand	334432 334433	341373 341373					SM5460 SM5460	SB101 SB101	SB101 SB101
2004-06	LS Model	Right Hand Left Hand	335052 335053							SB101 SB101	
1999-03	ALL Upper Spring Seat Insulator	Right Hand Left Hand	235630 235631	341293 341293				SM5388 SM5388	SM5091 SM5091 SM5433	SB103 SB103	SB107 SB107
1994-98	FWD		341141	341142		741018	741022	SM5091	SM5091	SB101	SB108
1989-93	FWD		235032	341054		734005	741013	SM5242	SM5091	SB101	SB107
1989-92	AWD		235032	341121		734005	741014	SM5242	SM5091	SB101	SB107
1985-88	ALL (Exc. Adj. Susp.) (Exc. ABS Brakes) ALL w/ ECS		235007	341054					SM5091	SB104	SB107
								SM5321			

## MITSUBISHI Lancer

2008-10	DE & ES Models	Right Hand Left Hand	339104 339105	341444 341444							
	GTS Model	Right Hand Left Hand	339082 339083	341425 341425							
2008	Strut / Shock Boot									SB101	SB108
2006-08	Strut / Shock Mount								SM5091		
2006-07	ES Model		334420	341368						SB101	SB108
2006	SE Model		334420	341368						SB101	SB108
2004-06	Ralliart (Exc. Sportback)		334369					SM5461	SM5091	SB101	SB108
2004	Sportback (Wagon) Sportback Ralliart Wagon		334420 334369	341368 341368				SM5461 SM5461	SM5091 SM5091	SB101 SB101	SB108 SB108
2002-06	LS Model OZ Rally Evolution Strut Mount Bearing (Exc. Evolution)		334420 334420	341368 341368 341349				SM5461 SM5461	SM5091 SM5091	SB101 SB101 SB104	SB108 SB108
2002-05	ES Model		333382	341342				SM5461	SM5091	SB101	SB108









## MITSUBISHI Mirage

4/97-02	1.8 L Eng. w/ 6" Spring O.D.	Right Hand Left Hand	333318 333319	341140 341140			741033 741033	SM5320 SM5320	SM5091 SM5091	SB103 SB103	SB108 SB108
	ALL 1.5 L Eng.	Right Hand Left Hand	332112 332113	341140 341140			741033 741033	SM5320 SM5320 SM5152	SM5091 SM5091	SB103 SB103	SB108 SB108
	Strut Mount w/ Bearing										
1997 - 3/97	ALL	Right Hand Left Hand	333224 333225	341140 341140			741033 741033	SM5311 SM5311	SM5091 SM5091	SB103 SB103	SB108 SB108

Notes de bas de Page 320 - Guia de notas al calce del catalogo Pg. 321

Bold part numbers indicate the most comparable KYB product to the original design & performance.  
(2) For vehicles with Electronic Susp., Leveling Control, and Air Suspensions refer to Appendix C.

# Applications For Pass. Cars, Light Trucks, SUV's, & Vans

VEHICLE MAKE, MODEL & YEAR		  	STRUT & SHOCK		BOOT KITS						
MARQUE, MODELE ET			MOUNTS								
ANNEE DU VEHICULE											
LA MARCA EL MODELO & AÑO											
											

## MITSUBISHI Mirage (continued)

1993-9/94	1.5L, 1.8L w/ 6" Spring O.D.	Right Hand Left Hand	234061 234062	341140 341140					SM5109 SM5109	SM5091 SM5091	SB101 SB101	SB108 SB108
1989-92	ALL		235033	341084					SM5063	SM5091	SB101	SB108
1987-88	ALL w/ Power Steering ALL w/o Power Steering		233025 233025	342014 342014		KG3200A KG3200A			SM5061 SM5062		SB104 SB104	
1985-86	ALL		233013	342014		KG3200A			SM5316		SB104	

## MITSUBISHI Montero

2005-06	Strut Mounting Kit Upper Spring Seat Insulator								SM5314 SM5345			
2001-04	ALL Upper Spring Seat Insulator		341251	344300	KG9144	KG5743			SM5314 SM5345		SB104	
1997-00	ALL (Exc. Adjustable Susp.)				KG54302	KG54303	565024	565025				
1992-96	ALL (Exc. Adjustable Susp.) ALL (For Adapting VSA to Non-VSA Suspension)				KG54302 KG54302 <sup>c</sup>	KG54303 KG54303 <sup>c</sup>	565024 565024 <sup>c</sup>	565025 565025 <sup>c</sup>				
1989-91	ALL w/ V6 Engine				KG5603A	KG5491						
1983-89	ALL (Exc. V6 Engine)			344045	KG5603A	KG4034						

## MITSUBISHI Montero (4WD) - Steering Stabilizer

1986-88	Complete Kit		SS15345									
---------	--------------	--	---------	--	--	--	--	--	--	--	--	--

## MITSUBISHI Montero Sport

2000-04	ALL		344294	344295								
1997-99	ALL			344045	KG54302	KG4034	565024					





## MITSUBISHI Outlander

2010	GT Model	Right Hand Left Hand	339080 339081	349040 349040						SM5091 SM5091	SB101 SB101	SB108 SB108
2009-10	ES Model	Right Hand	339124 <sup>68</sup>	341454 <sup>68</sup>						SM5091	SB101	SB108
		Left Hand	339125 <sup>68</sup>	341454 <sup>68</sup>						SM5091	SB101	SB108
	SE w/ 3rd Row Seating	Right Hand	339080	349040						SM5091	SB101	SB108
		Left Hand	339081	349040						SM5091	SB101	SB108
SE w/o 3rd Row Seating	Right Hand	339124 <sup>68</sup>	341454 <sup>68</sup>									
	Left Hand	339125 <sup>68</sup>	341454 <sup>68</sup>									
2008-10	LS Model	Right Hand	339124 <sup>68</sup>	341454 <sup>68</sup>						SM5091	SB101	SB108
		Left Hand	339125 <sup>68</sup>	341454 <sup>68</sup>						SM5091	SB101	SB108
	XLS	Right Hand	339080	349040						SM5091	SB101	SB108
		Left Hand	339081	349040						SM5091	SB101	SB108
2008	ES & SE Models	Right Hand Left Hand	339124 <sup>68</sup> 339125 <sup>68</sup>	341454 <sup>68</sup> 341454 <sup>68</sup>					SM5091 SM5091	SB101 SB101	SB108 SB108	
2007-08	Strut Mount Bearing								SM5128			
2007	ALL	Right Hand	339080	349040						SM5091	SB101	SB108
		Left Hand	339081	349040						SM5091	SB101	SB108
2005-06	ALL Strut Mount Bearing		334368	341348					SM5461 SM5128	SM5091	SB101	SB108
2003-04	ALL Strut Mount Bearing		334368	341361					SM5461 SM5128	SM5091	SB101	SB108

<sup>68</sup> New Part Number; Available 3rd Quarter 2011

<sup>c</sup> To convert from Electronic Susp. - See Appendix C

# Applications For Pass. Cars, Light Trucks, SUV's, & Vans

VEHICLE MAKE, MODEL & YEAR		<b>GR-2</b> <i>Excel-G</i>		<b>Gas-a-Just</b>		<b>MonoMax</b> 56XXX Series <b>AGX</b> 7XXXX Series		STRUT & SHOCK MOUNTS		BOOT KITS	
MARQUE, MODELE ET ANNEE DU VEHICULE											
LA MARCA EL MODELO & AÑO											

## MITSUBISHI Pickup

1982-96	2WD 4WD	344047 344047	344044 344045	KG5433 KG5433	KG5445 KG5438						
1979-81	ALL	344047	344044	KG5433	KG5434						

## MITSUBISHI Precis

1990-94	ALL	234043			KG4192			SM5060		SB116	
1989	ALL	365074			KG4192			SM5032		SB116	
1987-88	ALL	365027			KG4192			SM5032		SB103	

## MITSUBISHI Raider

2008-09	Strut Boot Upper Spring Seat							SM5546		SB103	
2006-07	ALL Upper Spring Seat		344378		KG54321			SM5510 SM5546		SB103	

## MITSUBISHI Sigma

1989-90	ALL (Exc. Adj. Susp.) (Exc. ABS Brakes) Mount Insulator & Bearing	235007	341054					SM5091 SM5319		SB101	SB107
1988	ALL (Exc. Adj. Susp.) (Exc. ABS Brakes)	235007	341054					SM5316	SM5091	SB104	SB107

## MITSUBISHI Starion

9/86-89	ALL (Exc. Adj. Susp.)	Right Hand Left Hand	365060 365060					SM5313 SM5313	SM5310 SM5310	SB102 SB102	SB101 SB101
1983-8/86	ALL (Exc. Adj. Susp.)	Right Hand Left Hand	365029 365029					SM5313 SM5313	SM5310 SM5310	SB102 SB102	SB102 SB102

## MITSUBISHI Tredia

1983-88	ALL	235006			KG4192			SM5095		SB103	
---------	-----	--------	--	--	--------	--	--	--------	--	-------	--

## MITSUBISHI Van, Wagon

1987-90	ALL	344427	344426	KG5444	KG5401						
---------	-----	--------	--------	--------	--------	--	--	--	--	--	--

## NISSAN 110

1970-73	110-Coupe 1200 Shock (Sleeve) Adapter Kit 110-Sedan 1200		343143 <sup>5</sup> KIT105 343140							SB103 SB103	
---------	--	--	---	--	--	--	--	--	--	----------------	--











## NISSAN 200SX

1995-99	ALL	Right Hand	333219	341194			733008	741021	SM5066	SM5154	SB101	SB108
1995-98	ALL	Left Hand	333220	341194			733009	741021	SM5066 SM5153 SM5128 SM5559	SM5154	SB101	SB108
1985-88	ALL		365031	343210								
1984-88	Strut Mounting Kit								SM5322			
1984	1.8L Turbo ALL (Exc. 1.8L Turbo)		365031 365031	343210					SM5064 SM5064		SB103 SB103	
1980-83	ALL		364003	343140							SB103	
1976-79	ALL			343140							SB103	

<sup>5</sup> Use Kit #105



# Applications For Pass. Cars, Light Trucks, SUV's, & Vans

VEHICLE MAKE, MODEL & YEAR	<b>GR-2</b>	<b>Gas-a-Just</b>	<b>MonoMax</b> 56XXXX Series	STRUT & SHOCK	
MARQUE, MODELE ET	<b>Excel-G</b>		<b>AGX</b> 7XXXXX Series	MOUNTS	BOOT KITS
ANNEE DU VEHICULE	 	 	 	 	 
LA MARCA EL MODELO & AÑO					

## NISSAN 210

1979-82	ALL	364003	343140		KG4764A					SB103	
1973-78	Hatchback	364003	343143 <sup>5</sup>							SB103	
	Shock (Sleeve) Adapter Kit	364003	KIT105							SB103	
	Sedan		343140							SB103	

## NISSAN 240SX

1995-98	ALL	Right Hand	334184	341222			734023	741045	SM5101	SM5154	SB104	SB108
		Left Hand	334185	341222			734024	741045	SM5101	SM5154	SB104	SB108
1989-94	ALL (Exc. Hicas Susp.)	Right Hand	234051	341099			733006	741017	SM5101	SM5154	SB103	SB108
		Left Hand	234052	341099			733007	741017	SM5101	SM5154	SB103	SB108
	ALL w/ Hicas Susp.	Right Hand	234051				733006		SM5101		SB103	
		Left Hand	234052				733007		SM5101		SB103	

## NISSAN 240Z

1970-74	ALL		361002	361001					SM5064		SB103	SB103
	Strut Mount Bearing											

## NISSAN 260Z

1974-75	ALL (Exc.2+2) From Chassis No. RLS30-060001		361002	361003					SM5064		SB103	SB103
	Strut Mount Bearing											
1974	ALL (Exc.2+2) Thru Chassis No. RLS30-060000		361002	361001							SB103	SB103

## NISSAN 280Z

1975-78	ALL		361002	361003					SM5064		SB103	SB103
	Strut Mount Bearing											

## NISSAN 280ZX

9/81-83	ALL		365013			KG9113 <sup>2</sup>					SB103	
12/80-8/81	ALL w/ Turbo		365013			KG9113 <sup>2</sup>					SB103	
1979-83	Strut Mount Bearing								SM5064			
1979-8/81	ALL (Exc. Turbo)		365013	341012		KG9101 <sup>2</sup>					SB103	

## NISSAN 300ZX

1990-96	ALL (Exc. Adjustable Susp.)	Right Hand	341149	341151			741026	741028	SM5196	SM5154	SB101	SB108
		Left Hand	341150	341151			741027	741028	SM5196	SM5154	SB101	SB108
	ALL (For Adapting ECVSA to Non-ECVSA Suspension)	Right Hand	341149 <sup>C</sup>	341151 <sup>C</sup>			741026 <sup>C</sup>	741028 <sup>C</sup>			SB101	SB108
		Left Hand	341150 <sup>C</sup>	341151 <sup>C</sup>			741027 <sup>C</sup>	741028 <sup>C</sup>			SB101	SB108
1984-89	ALL (Exc. Adjustable Susp.)		365056			KG5787A			SM5097	SM5325	SB104	SB107
	ALL (For Adapting ECVSA to Non-ECVSA Suspension)		365056 <sup>C</sup>			KG5787A <sup>C</sup>					SB104	
	Conversion Kit		KIT108A <sup>C</sup>			KIT108A <sup>C</sup>						
	Strut Mount Bearing								SM5064			

## NISSAN 350Z

2009	Convertible								SM5542 <sup>70</sup>	SM5482	SB101	
2006-08	ALL								SM5542 <sup>70</sup>	SM5482	SB101	
	Upper Spring Seat Insulator								SM5560			
2004-05	ALL	Right Hand	341366	344455					SM5542 <sup>70</sup>	SM5482	SB101	
		Left Hand	341367	344455					SM5542 <sup>70</sup>	SM5482	SB101	
	Upper Spring Seat Insulator								SM5560			

<sup>2</sup> The KYB replacement unit comes with a new dustcover/ bumper assembly.

<sup>5</sup> Use Kit #105

<sup>70</sup> New Part Number, Available 2nd Quarter 2011

<sup>C</sup> To convert from Electronic Susp - See Appendix C

# Applications For Pass. Cars, Light Trucks, SUV's, & Vans

VEHICLE MAKE, MODEL & YEAR	<b>GR-2</b>		<b>Gas-a-Just</b>		<b>MonoMax</b> 56XXXX Series		STRUT & SHOCK			
MARQUE, MODELE ET	<b>Excel-G</b>				<b>AGX</b>		MOUNTS		BOOT KITS	
ANNEE DU VEHICULE					7XXXXX Series					
LA MARCA EL MODELO & AÑO										

## NISSAN 350Z (continued)

2003	ALL	Right Hand	341366	344455					SM5542 <sup>70</sup>	SM5482	SB101	SB108
		Left Hand	341367	344455					SM5542 <sup>70</sup>	SM5482	SB101	SB108
	Upper Spring Seat Insulator								SM5560			

## NISSAN 370Z

2009	Coupe										SB103	
------	-------	--	--	--	--	--	--	--	--	--	-------	--

## NISSAN 410, 411

1964-69	ALL		343127	343135	KG4515							
---------	-----	--	--------	--------	--------	--	--	--	--	--	--	--

## NISSAN 510

1978-81	ALL (Exc. Station Wagon)		364003	343140							SB103	
	Station Wagon		364003								SB103	
1968-73	Sedan & Coupe			343149							SB103	
1968-72	Station Wagon			343135							SB103	

## NISSAN 610

1972-76	ALL (Exc. Station Wagon)			343149							SB103	
	Station Wagon			343157							SB103	

## NISSAN 710

1973-77	ALL (Exc. Station Wagon)			343149							SB103	
	Station Wagon			343157							SB103	

## NISSAN 810

1981	Sedan		365013	341012		KG9101 <sup>2</sup>					SB103	
	Station Wagon		365013						SM5064		SB103	
1977-80	Sedan & Coupe			341012		KG9101 <sup>2</sup>			SM5064		SB103	
	Station Wagon			343157					SM5064		SB103	

## NISSAN Altima

2010	Sedan (Exc. Hybrid)		Right Hand	339146								
			Left Hand	339147								
	Base & S Models (Sedan Only)			349075								
2008-09	Coupe			349075								
2007-10	ALL								SM5381		SB102	SB108
2007-09	Sedan (Exc. Hybrid)		Right Hand	339146	349075							
			Left Hand	339147	349075							
	Hybrid			349075								
2002-06	ALL		Right Hand	334336	344395				SM5409	SM5381	SB104	SB108
			Left Hand	334337	344395				SM5409	SM5381	SB104	SB108
1998-01	ALL		Right Hand	235607	334135				SM5218	SM5107	SB101	SB103
			Left Hand	235608	334136				SM5218	SM5107	SB101	SB103
1993-97	ALL		Right Hand	235607	334135				SM5106	SM5107	SB101	SB103
			Left Hand	235608	334136				SM5106	SM5107	SB101	SB103













## NISSAN Armada

2005-09	ALL (Exc. Auto Rear Leveling & Off Road Package)		341600	345066								
2005-07	ALL w/ Off-Road Package		341600									

<sup>2</sup> The KYB replacement unit comes with a new dustcover/ bumper assembly.

<sup>70</sup> New Part Number, Available 2nd Quarter 2011

# Applications For Pass. Cars, Light Trucks, SUV's, & Vans

VEHICLE MAKE, MODEL & YEAR		  	STRUT & SHOCK		BOOT KITS	
MARQUE, MODELE ET			MOUNTS			
ANNEE DU VEHICULE						
LA MARCA EL MODELO & AÑO						
		 	 	 	 	 

## NISSAN Axxess

1990-94	AWD	Right Hand	235051						SM5102			
		Left Hand	235052						SM5102			
	FWD	Right Hand	235051						SM5102	SM5100	SB103	SB103
		Left Hand	235052						SM5102	SM5099	SB103	SB103
	Strut Mount Bearing								SM5064			

## NISSAN Cube

2009-10	ALL	Right Hand	333390									
		Left Hand	333391									

## NISSAN Datsun 1600/1800/2000 Roadsters (310, 311 SPL)

1962-70	Datsun 1600, 1800, 2000 Roadsters	343138	343136	KG4528								
---------	-----------------------------------	--------	--------	--------	--	--	--	--	--	--	--	--

## NISSAN Frontier (2WD)

2009	ALL (Exc. PRO-4X)	341467	345067		555051							
9/2005-08	ALL (Exc. Nismo Off Road)	341467	345067		555051							
2005-08	ALL w/ Nismo Off Road		345067		555051							
05 - 9/2005	ALL (Exc. Nismo Off Road)	341467	345075									
2000-04	ALL w/ 3.3L (Exc. Supercharger)	344469	344015	KG5615	KG4026							
2002-04	ALL w/ Supercharger	344469	344429	KG5615	KG5473							
2001	ALL w/ Supercharger	344043	344044	KG5446	KG4012	565045	565028					
3/2003-04	ALL w/ 2.4L	344468	344429	KG5614	KG5473							
98-3/2003	ALL w/ 2.4L	344427	344429	KG5444	KG5473							

## NISSAN Frontier (4WD)

2009	ALL (Exc. PRO-4X)	341467	345067		555051							
9/2005-08	ALL (Exc. Nismo Off Road)	341467	345067		555051							
2005-08	ALL w/ Nismo Off Road		345067		555051							
05 - 9/2005	ALL (Exc. Nismo Off Road)	341467	345075									
2002-04	ALL	344469	344015	KG5615	KG4026							
2001	ALL w/ Supercharger	344043	344044	KG5446	KG4012	565045	565028					
2000-01	ALL (Exc. Crew Cab & Supercharger)	344043	344044	KG5446	KG4012	565045	565028					
	ALL w/ Crew Cab (Exc. Supercharger)	344469	344015	KG5615	KG4026							
1998-99	ALL	344043	344044	KG5446	KG4012	565045	565028					

## NISSAN GT-R

2009-10	Strut / Shock Boot										SB103	SB101
---------	--------------------	--	--	--	--	--	--	--	--	--	-------	-------













## NISSAN Maxima (Exc. Electronically Adj. Susp.)

2009-10	Strut Boot										SM5381	SB102	SB108
	Strut / Shock Mount												
2004-08	ALL	Right Hand	334336	344450					SM5409	SM5381	SB104	SB108	
		Left Hand	334337	344450					SM5409	SM5381	SB104	SB108	
2002-03	ALL	Right Hand	334366	341341					SM5409	SM5217	SB104	SB108	
		Left Hand	334367	341341					SM5409	SM5217	SB104	SB108	
2000-01	ALL	Right Hand	334265	341271					SM5409	SM5217	SB104	SB108	
		Left Hand	334266	341271					SM5409	SM5217	SB104	SB108	
1995-99	ALL	Right Hand	334150	341202			734017	741039	SM5324	SM5123	SB104	SB108	
		Left Hand	334151	341202			734018	741039	SM5324	SM5123	SB104	SB108	
	Strut Mount w/ Bearing								SM5122				

Notes de bas de Page 320 - Guia de notas al calce del catalogo Pg. 321

Bold part numbers indicate the most comparable KYB product to the original design & performance.  
(2) For vehicles with Electronic Susp., Leveling Control, and Air Suspensions refer to Appendix C.

# Applications For Pass. Cars, Light Trucks, SUV's, & Vans

VEHICLE MAKE, MODEL & YEAR	  	STRUT & SHOCK		BOOT KITS	
MARQUE, MODELE ET		MOUNTS			
ANNEE DU VEHICULE					
LA MARCA EL MODELO & AÑO					
	 	 	 	 	 

## NISSAN Maxima (Exc. Electronically Adj. Susp.) (continued)

1995-99	Strut Mount Bearing Upper Spring Seat Insulator							SM5323	SM5529		
1989-94	ALL	Right Hand	235051	365079				SM5102	SM5100	SB103	SB101
		Left Hand	235052	365079				SM5102	SM5099	SB103	SB101
	ALL (For Adapting Sonar II to Non-Sonar Suspension II)	Right Hand	235051 <sup>c</sup>	365079 <sup>c</sup>						SB103	SB101
		Left Hand	235052 <sup>c</sup>	365079 <sup>c</sup>						SB103	SB101
	Strut Mount Bearing							SM5064			
1986-88	ALL	Right Hand	235019	361008				SM5065	SM5100	SB104	SB103
		Left Hand	235020	361008				SM5065	SM5099	SB104	SB103
	ALL (For Adapting ECVSA to Non-ECVSA Suspension)	Right Hand	235019 <sup>c</sup>	365080 <sup>c</sup>				SM5065			
		Left Hand	235020 <sup>c</sup>	365080 <sup>c</sup>				SM5065			
1985	ALL	Right Hand	235030	361008				SM5065	SM5100	SB104	SB103
		Left Hand	235031	361008				SM5065	SM5099	SB104	SB103
	ALL (For Adapting ECVSA to Non-ECVSA Suspension)	Right Hand	235030 <sup>c</sup>	365080 <sup>c</sup>				SM5065			
		Left Hand	235031 <sup>c</sup>	365080 <sup>c</sup>				SM5065			
1981-84	Sedan		365013	341012		KG9101 <sup>2</sup>				SB103	
	Station Wagon		365013					SM5064		SB103	

## NISSAN Micra (Canadian Vehicle)

1983-92	ALL	Right Hand	232017	341056							
		Left Hand	232018	341056							

## NISSAN Multi (Canadian Vehicle)

1986-89	2WD			344055		KG5538			SM5048		
1986-88	Strut Mounting Kit								SM5327		
1982-85	2WD		364004	344055		KG5538			SM5048		SB102

## NISSAN Murano

2009-10	ALL	Right Hand	339188 <sup>68</sup>	349092 <sup>68</sup>							SB101
		Left Hand	339189 <sup>68</sup>	349092 <sup>68</sup>							SB101
2003-07	ALL	Right Hand	334380	344439					SM5409	SM5462	SB104
		Left Hand	334381	344439					SM5409	SM5462	SB104

## NISSAN NX

1991-95	ALL	Right Hand	234048	232031			733014	732001		SM5085	SB103
		Left Hand	234049	232032			733015	732002		SM5085	SB103

## NISSAN Pathfinder (2WD) (Exc. Armada) (Exc. Adjustable Suspension)





2005-10	ALL		341468	345056		555057					
2004	ALL	Right Hand	335035	343379		KG4163			SM5203		SB129
		Left Hand	335036	343379		KG4163			SM5203		SB129
2002-03	ALL	Right Hand	335035	343379		KG4163			SM5203		SB129
		Left Hand	335036	343379		KG4163			SM5203		SB129
12/98-01	ALL	Right Hand	335030	343379		KG4163			SM5203		SB129
		Left Hand	335031	343379		KG4163			SM5203		SB129
1996-04	Strut Mount, Bearing & Boot kit Strut Mount Bearing								SM5329 SM5323		
1996-11/98	ALL	Right Hand	335015	343388		KG54318			SM5203		SB129
		Left Hand	335016	343388		KG54318			SM5203		SB129
1989-95	ALL		344430	344045	KG5476	KG5438					
	ALL (For Adapting ASA to Non-ASA Suspension)				KG5476 <sup>c</sup>	KG5438 <sup>c</sup>					

<sup>2</sup> The KYB replacement unit comes with a new dustcover/ bumper assembly.

<sup>68</sup> New Part Number: Available 3rd Quarter 2011

<sup>c</sup> To convert from Electronic Susp - See Appendix C

# Applications For Pass. Cars, Light Trucks, SUV's, & Vans

VEHICLE MAKE, MODEL & YEAR		<b>GR-2</b>		<b>Gas-a-Just</b>		<b>MonoMax</b> 56XXXX Series		STRUT & SHOCK			
MARQUE, MODELE ET		<b>Excel-G</b>				<b>AGX</b> 7XXXX Series		MOUNTS		BOOT KITS	
ANNEE DU VEHICULE											
LA MARCA EL MODELO & AÑO											
											

## NISSAN Pathfinder (4WD) (Exc. Armada) (Exc. Adjustable Suspension)

2005-10	ALL		341468	345056		555057					
2004	ALL	Right Hand	335032	343379		KG4163			SM5203		SB129
		Left Hand	335033	343379		KG4163			SM5203		SB129
2002-03	ALL	Right Hand	335032	343379		KG4163			SM5203		SB129
		Left Hand	335033	343379		KG4163			SM5203		SB129
12/98-01	ALL	Right Hand	335030	343379		KG4163			SM5203		SB129
		Left Hand	335031	343379		KG4163			SM5203		SB129
1996-04	Strut Mount, Bearing & Boot kit Strut Mount Bearing								SM5329 SM5323		
1996-11/98	ALL	Right Hand	335015	343388		KG54318			SM5203		SB129
		Left Hand	335016	343388		KG54318			SM5203		SB129
1987-95	ALL ALL (For Adapting ASA to Non-ASA Suspension)		344430	344045	KG5476 KG5476 <sup>c</sup>	KG5438 KG5438 <sup>c</sup>					

## NISSAN Pathfinder Armada

2004	Pathfinder Armada (Exc. Auto Rear Leveling)		341600	345066							
------	--	--	--------	--------	--	--	--	--	--	--	--

## NISSAN Pickup (2WD)

1995-97	ALL		343208	344097	KG4605A	KG5473	565029	565057			
1986-94	D21		343208	344097	KG4605A	KG5473	565029	565057			
1982-86	720		343208	344046	KG4605A	KG5447	565029				
1981	ALL		343208	344046	KG4605A	KG5447	565029				
1965-80	ALL		343208	344046	KG4605A	KG5447	565029				

## NISSAN Pickup (4WD)

1995-97	ALL		344043	344044	KG5446	KG4012	565045	565028			
1986-94	D21		344043	344044	KG5446	KG4012	565045	565028			
1982-86	720		344043	344045	KG5446	KG5438	565045				
1981	ALL		344043	344046	KG5446	KG5447	565045				
1965-80	ALL		343208	344046	KG4605A	KG5447	565029				

## NISSAN Pickup - Lift Replacement Shocks

12/85-97	4WD Lift = 0-2"						565083	565028			
----------	-----------------	--	--	--	--	--	--------	--------	--	--	--

## NISSAN Pulsar

1987-90	ALL	Right Hand	232009	232007					SM5048	SM5048	SB101	SB103
		Left Hand	232010	232008					SM5048	SM5048	SB101	SB103
	Strut Mounting Kit								SM5327			
1983-90	Strut Mount Bearing								SM5128			
1983-86	ALL (Exc. Turbo)	Right Hand	232003	342008		KG3792A			SM5048		SB101	
		Left Hand	232004	342008		KG3792A			SM5048		SB101	











## NISSAN Quest Mini-Van

2004-09	ALL	Right Hand	334454	344479					SM5409	SM5462	SB101	SB103
		Left Hand	334455	344479					SM5409	SM5462	SB101	SB103
1999-02	ALL	Right Hand	334321	344055		KG5538		565065	SM5098		SB103	
		Left Hand	334322	344055		KG5538		565065	SM5098		SB103	
	Strut Mount w/ Bearing Strut Mount Bearing								SM5326 SM5064			

<sup>c</sup> To convert from Electronic Susp - See Appendix C

Notes de bas de Page 320 - Guia de notas al calce del catalogo Pg. 321  
 Bold part numbers indicate the most comparable KYB product to the original design & performance.  
 (22) For vehicles with Electronic Susp., Leveling Control, and Air Suspensions refer to Appendix C.

# Applications For Pass. Cars, Light Trucks, SUV's, & Vans

VEHICLE MAKE, MODEL & YEAR	<b>GR-2</b>	<b>Gas-a-Just</b>	<b>MonoMax</b> 56XXXX Series	STRUT & SHOCK			
MARQUE, MODELE ET	<b>Excel-G</b>		<b>AGX</b> 7XXXX Series	MOUNTS		BOOT KITS	
ANNEE DU VEHICULE	 	 	 	 	 		
LA MARCA EL MODELO & AÑO							

## NISSAN Quest Mini-Van (continued)

1999-02	Upper Spring Seat Lower Spring Seat Insulator							SM5554 SM5521			
1993-98	ALL Right Hand Left Hand Strut Mount w/ Bearing Strut Mount Bearing Upper Spring Seat Lower Spring Seat Insulator	235058 235059	344055 344055		KG5538 KG5538		565065 565065	SM5098 SM5098 SM5326 SM5064 SM5554 SM5521		SB103 SB103	

## NISSAN Rogue

2008-10	ALL Right Hand Left Hand	339196 339197	349097 349097								
---------	--------------------------------	------------------	------------------	--	--	--	--	--	--	--	--

## NISSAN Sentra

2007-10	ALL (Exc. SE-R & Spec-V) ALL Strut Boot	Right Hand Left Hand	333604 333605	341659 341659							SB101
2002-06	ALL (Exc. SE-R & Spec-V) SE-R, SE-R Spec-V	Right Hand Left Hand Right Hand Left Hand	333310 333311 333394 333395	341279 341279 341279 341279				SM5216 SM5216 SM5216 SM5216	SM5213 SM5213 SM5213 SM5213	SB101 SB101 SB101 SB101	SB108 SB108 SB108 SB108
2000-01	ALL	Right Hand Left Hand	333344 333345	341279 341279				SM5216 SM5216	SM5213 SM5213	SB101 SB101	SB108 SB108
1995-99	ALL (B14) Strut Mount Bearing Upper Spring Seat w/ Insulator	Right Hand Left Hand	333219 333220	341194 341194		733008 733009	741021 741021	SM5066 SM5066 SM5128 SM5559	SM5154 SM5154	SB101 SB101	SB108 SB108
1991-95	ALL (B13) Strut Mount Bearing	Right Hand Left Hand	234048 234049	232031 232032		733014 733015	732001 732002	SM5066 SM5066 SM5128	SM5085 SM5085	SB101 SB101	SB101 SB101
1987-90	4WD Station Wagon ALL (Exc. 4WD Station Wagon)	Right Hand Left Hand Right Hand Left Hand	232009 232010 232009 232010					SM5048 SM5048 SM5048 SM5048		SB103 SB103 SB101 SB101	
1/1/86-90	Strut Mounting Kit							SM5327			
1982-86	ALL Strut Mount Bearing	Right Hand Left Hand	232003 232004	342008 342008	KG3792A KG3792A			SM5048 SM5048 SM5128		SB117 SB117	

## NISSAN Sentra Classic (Canadian Vehicle)

1991-92	ALL Strut Mounting Kit Strut Mount Bearing	Right Hand Left Hand	232009 232010	232007 232008				SM5048 SM5048 SM5327 SM5128	SM5048 SM5048	SB101 SB101	SB101 SB101
---------	--	-------------------------	------------------	------------------	--	--	--	--------------------------------------	------------------	----------------	----------------









## NISSAN Stanza

1990-92	ALL	Right Hand Left Hand		365079 365079					SM5100 SM5099	SB103 SB103	SB104 SB104
1987-89	Sedan & Hatchback	Right Hand Left Hand	235019 235020	361008 361008				SM5065 SM5065	SM5099 SM5100	SB104 SB104	SB103 SB103
1986-88	FWD Station Wagon Strut Mount Kit, FWD Station Wagon			344055	KG5538			SM5048 SM5327			
1982-86	Sedan & Hatchback		364004	364005					SM5325	SB102	SB102
1982-85	2WD Station Wagon		364004	344055	KG5538					SB102	

Notes de bas de Page 320 - Guia de notas al calce del catalogo Pg. 321

Bold part numbers indicate the most comparable KYB product to the original design & performance.  
(2) For vehicles with Electronic Susp., Leveling Control, and Air Suspensions refer to Appendix C.

# Applications For Pass. Cars, Light Trucks, SUV's, & Vans

VEHICLE MAKE, MODEL & YEAR	<b>GR-2</b>	<b>Gas-a-Just</b>	<b>MonoMax</b> 56XXXX Series	STRUT & SHOCK	
MARQUE, MODELE ET	<b>Excel-G</b>		<b>AGX</b> 7XXXXX Series	MOUNTS	BOOT KITS
ANNEE DU VEHICULE	 	 	 	 	 
LA MARCA EL MODELO & AÑO					

## NISSAN Titan (2WD)

2008-10	ALL	341600							
2004-07	ALL	341600	345042		KG6197				

## NISSAN Titan (4WD)

2008-10	ALL	341600							
2004-07	ALL	341600	345043		KG6196				

## NISSAN Versa

2007-10	S & SL Models	Right Hand	333390	343465					
		Left Hand	333391	343465					

## NISSAN X-Trail (Canadian Vehicle)

2005-06	ALL	Right Hand	335602 <sup>70</sup>	335604 <sup>70</sup>					
		Left Hand	335603 <sup>70</sup>	335605 <sup>70</sup>					

## NISSAN Xterra

2005-10	4WD	341468	345068		555052				
	RWD	341468	345075						
2000-04	ALL		344015	KG5446	KG4026	565045			

## NISSAN Xterra - Lift Replacement Shocks

2000-04	ALL Lift = 0-2"					565083			
---------	-----------------	--	--	--	--	--------	--	--	--

## OLDSMOBILE 442

1968-71	ALL	343127	343157	KG4513	KG5504				
1965-67	ALL	343128	343130	KG4515	KG5507				

## OLDSMOBILE 88, Delta 88 (Exc. Electronic Susp.) (also see STRUT-PLUS)

1991-99	ALL w/ Self Leveling Rear ALL w/o Self Leveling Rear Spring Seat w/ Insulator Lower Spring Seat Insulator	236007 236007	SR1003 <sup>17</sup> 235025					SM5057 SM5057 SM5230 SM5412	SM5017 SM5017	SB104 SB104	SB128
1990	Early Design Front Struts (w/ SpringGuard) w/ Self-Level Rear Early Design Front Struts (w/ SpringGuard) w/o Self-Level Rear Late Design Front Struts (w/o SpringGuard) w/ Self-Level Rear Late Design Front Struts (w/o SpringGuard) w/o Self-Level Rear ALL (For Adapting Air Shock / Strut to Non-Air Suspension) Early Design Front Struts (w/ Spring Guard) Strut Mounting Kit Upper Spring Seat w/ Isolator Late Design Front Struts (w/o SpringGuard) Upper Spring Seat w/ Insulator Early Design Front Struts (w/ Spring Guard) Lower Spring Seat Insulator Late Design Front Struts (w/o SpringGuard) Lower Spring Seat Insulator	236002 236002 236007 236007	SR1003 <sup>17</sup> 235025 SR1003 <sup>17</sup> 235025 SR4023					SM5026 SM5026 SM5057 SM5057 SM5281 SM5350 SM5230 SM5411 SM5412	SM5017 SM5017 SM5017 SM5017	SB105 SB105 SB104 SB104	SB104 SB104
1987-96	Strut Mount Bearing							SM5284			
1987-89	Delta 88 w/ Self Leveling Rear Delta 88 w/o Self Leveling Rear ALL (For Adapting Air Shock / Strut to Non-Air Suspension)	236002 236002	SR1003 <sup>17</sup> 235025 SR4023					SM5026 SM5026	SM5017 SM5017	SB105 SB105	SB104

<sup>17</sup> Air Strut: A Coil Spring Compressor is not needed













<sup>70</sup> New Part Number, Available 2nd Quarter 2011

Notes de bas de Page 320 - Guia de notas al calce del catalogo Pg. 321

Bold part numbers indicate the most comparable KYB product to the original design & performance.

(22) For vehicles with Electronic Susp., Leveling Control, and Air Suspensions refer to Appendix C.

# Applications For Pass. Cars, Light Trucks, SUV's, & Vans

VEHICLE MAKE, MODEL & YEAR	  	STRUT & SHOCK		BOOT KITS	
MARQUE, MODELE ET		MOUNTS			
ANNEE DU VEHICULE					
LA MARCA EL MODELO & AÑO					
	 	 	 	 	 

## OLDSMOBILE 88, Delta 88 (Exc. Electronic Susp.) (also see STRUT-PLUS) (continued)

1987-89	Strut Mounting Kit Upper Spring Seat w/ Isolator Lower Spring Seat Insulator							SM5281 SM5350 SM5411			
1986	ALL w/ Self Leveling Rear ALL w/o Self Leveling Rear Strut Mounting Kit Upper Spring Seat w/ Isolator Lower Spring Seat Insulator	236002 236002	235025 <sup>21</sup> 235025					SM5281 SM5350 SM5411	SM5017 SM5017	SB105 SB105	SB104
1977-85	ALL	343127	343130	KG4515	KG5507						
1971-76	ALL	343127	343130	KG4515	KG5507						
1969-70	ALL	343128	343130	KG4515							
1965-68	ALL	343128		KG4515	KG5508						

## OLDSMOBILE 88, Delta 88 (Exc. Electronic Susp.) - STRUT-PLUS

1991-99	ALL w/ Self Leveling Rear ALL w/o Self Leveling Rear	SR4022 SR4022	NA <sup>60</sup> SR4023								
1990	Late Design Front Struts (w/o SpringGuard) w/ Self-Level Rear Late Design Front Struts (w/o SpringGuard) w/o Self-Level Rear Early Design Front Struts (w/ SpringGuard) w/ Self-Level Rear Early Design Front Struts (w/ SpringGuard) w/o Self-Level Rear	SR4022 SR4022	NA <sup>60</sup> SR4023 NA <sup>60</sup> SR4023								
1987-89	ALL w/ Self Leveling Rear ALL w/o Self Leveling Rear		NA <sup>60</sup> SR4023								
1986	ALL w/ Self Leveling Rear ALL w/o Self Leveling Rear		NA <sup>60</sup> SR4023								

## OLDSMOBILE 98 (Exc. Electronic Susp.) (also see STRUT-PLUS)

1991-96	ALL (Exc. Electronic Susp.) Lower Spring Seat Insulator	236007	SR1003 <sup>17</sup>					SM5057 SM5412	SM5017	SB104	SB128
1990-96	Spring Seat w/ Insulator							SM5230			
1987-96	ALL (For Adapting Air Shock / Strut to Non-Air Suspension) Strut Mount Bearing		SR4023					SM5284			
1987-90	ALL Insulator & Bearing	236002	SR1003 <sup>17</sup>					SM5026	SM5017	SB105	
1986-90	Upper Spring Seat w/ Isolator							SM5350			
1985-90	Strut Mounting Kit Lower Spring Seat Insulator							SM5281 SM5411			
1985-86	Coupe & Sedan (FWD)	236002	235025 <sup>21</sup>					SM5026	SM5017	SB105	
1977-84	Coupe & Sedan (RWD)	343127	343130	KG4515	KG5507						
1971-76	ALL	343127	343130	KG4515	KG5507						
1969-70	ALL	343128	343130	KG4515							
1965-68	ALL	343128		KG4515	KG5508						

## OLDSMOBILE 98 (Exc. Electronic Susp.) STRUT-PLUS

1991-96	ALL	SR4022	NA <sup>60</sup>								
1987-90	ALL		NA <sup>60</sup>								
1985-86	Coupe & Sedan (FWD)		NA <sup>60</sup>								













<sup>17</sup> Air Strut; A Coil Spring Compressor is not needed

<sup>21</sup> To replace the Original Equipment self-leveling air strut: use KYB gas strut # [235025] with Strut Boot Kit # [SB128]. Deactivate the self-leveling system per Appendix B.

<sup>60</sup> To eliminate the Original Equipment Air Strut, Use STRUT PLUS [SR4023]



# Applications For Pass. Cars, Light Trucks, SUV's, & Vans

VEHICLE MAKE, MODEL & YEAR	  	STRUT & SHOCK		BOOT KITS	
MARQUE, MODELE ET		MOUNTS			
ANNEE DU VEHICULE					
LA MARCA EL MODELO & AÑO					
	 	 	 	 	 

## OLDSMOBILE Achieva

1995-98	ALL w/o Swaybar Bracket Right Hand Left Hand	235604 235605	343402 343402		KG4552 KG4552 KG5576			SM5142 SM5142 SM5142 SM5284 SM5228 SM5431	SM5010 SM5010 SM5010	SB103 SB103 SB103	
	ALL w/ Swaybar Bracket Strut Mount Bearing Upper Spring Seat w/ Insulator Lower Spring Seat Insulator		343402								
1992-94	ALL w/o Swaybar Bracket Right Hand Left Hand	235604 235605	343177 343177		KG4536 KG4536 KG4536			SM5073 SM5073 SM5073	SM5010 SM5010 SM5010	SB103 SB103 SB103	
	ALL w/ Swaybar Bracket (Exc. Adj. Susp.) Strut Mount Bearing Upper Spring Seat w/ Isolator Lower Spring Seat Insulator		343177					SM5284 SM5349 SM5431			

## OLDSMOBILE Alero (also see STRUT-PLUS)

1999-04	ALL Upper Spring Seat Insulator Lower Spring Seat Insulator	334229	334295			734056	734057	SM5146 SM5438 SM5420	SM5145 SM5524	SB104	SB101
---------	---	--------	--------	--	--	--------	--------	----------------------------	------------------	-------	-------

## OLDSMOBILE Alero

1999-04	ALL	SR4001									
---------	-----	--------	--	--	--	--	--	--	--	--	--

## OLDSMOBILE Aurora

2001-03	ALL w/ Self Leveling Rear ALL w/o Self Leveling Rear Upper Spring Seat w/ Insulator (02-03) Upper Spring Seat w/ Insulator (2001) Lower Spring Seat Insulator	335037 335037	SR1002 <sup>16</sup>					SM5276 SM5276 SM5435 SM5436 SM5437	SM5334 SM5334	SB103 SB103	
1998-99	ALL Upper Spring Seat w/ Insulator Lower Spring Seat Insulator	339016						SM5276 SM5436 SM5437	SM5334	SB101	
1997	ALL w/ Self Leveling Rear Spring Seat w/ Insulator Shock Mount Lower Spring Seat Insulator	334677	SR1002 <sup>16</sup>					SM5230 SM5437	SM5334	SB101	
1995-96	ALL Strut Mount Bearing Spring Seat w/ Insulator Lower Spring Seat Insulator	236007						SM5286 SM5284 SM5230 SM5412	SM5334	SB101	

## OLDSMOBILE Bravada

2002-04	ALL Mount w/ Spring Insulator Lower Spring Seat Insulator	331043 <sup>81</sup>	343395		KG4162			SM5395 SM5548		SB108	
1991-01	ALL	344042	344041	KG5452	KG5451	565048	565047				

## OLDSMOBILE Bravada - Lift Replacement Shocks

1991-01	ALL Lift = 0-2"					565075	565047				
---------	-----------------	--	--	--	--	--------	--------	--	--	--	--

## OLDSMOBILE Calais













1987-91	ALL Right Hand Left Hand Upper Spring Seat w/ Isolator	231013 231014	343177 343177		KG4536 KG4536			SM5007 SM5007 SM5348	SM5010 SM5010	SB104 SB104	
1985-86	ALL w/ Sealed Struts Right Hand Left Hand ALL w/ Rebuildable Struts	231013 231014	343177 343177		KG4536 KG4536 KG4536			SM5007 SM5007 SM5007	SM5010 SM5010 SM5010	SB104 SB104 SB104	
		366003 <sup>18</sup>	343177								

<sup>16</sup> Box contains two shocks

<sup>18</sup> Strut must be cut to install cartridge. Check strut for a cut line groove (20mm from strut top). If no cut line groove is found, do not cut strut open as there are no threads inside. The complete strut must be replaced.

<sup>81</sup> Replaces [331016], when stock is depleted

# Applications For Pass. Cars, Light Trucks, SUV's, & Vans

VEHICLE MAKE, MODEL & YEAR	  	STRUT & SHOCK		BOOT KITS	
MARQUE, MODELE ET		MOUNTS			
ANNEE DU VEHICULE					
LA MARCA EL MODELO & AÑO					
	 	 	 	 	 

## OLDSMOBILE Calais (continued)

1985-86	Upper Spring Seat w/ Insulator							SM5348			
---------	--------------------------------	--	--	--	--	--	--	--------	--	--	--

## OLDSMOBILE Custom Cruiser

1977-92	ALL	343127	343157	KG4515	KG5504						
1971-76	ALL	343127	343157	KG4515							

## OLDSMOBILE Cutlass (also see STRUT-PLUS)

1998-99	ALL w/ 2.50" Rear Strut Bolt Hole Spacing From Late 1998 Upper Spring Seat Insulator Lower Spring Seat Insulator	334229	334295			734056	734057	SM5146 SM5438 SM5420	SM5145 SM5524	SB104	SB101
1997-98	ALL w/ 3.25" Rear Strut Bolt Hole Spacing to Early 1998 Upper Spring Seat Insulator Lower Spring Seat Insulator	334229	334230			734056		SM5146 SM5438 SM5420	SM5145	SB104	SB101
1978-88	ALL (RWD)	343127	343157	KG4513	KG5548						
1968-77	ALL	343127	343157	KG4513	KG5504						
1964-67	ALL	343128	343130	KG4515	KG5507						

## OLDSMOBILE Cutlass

1998-99	Cutlass w/ 2.50" Rear Strut Bolt Hole Spacing From Late 1998	SR4001									
1997-98	Cutlass w/ 3.25" Rear Strut Bolt Hole Spacing to Early 1998	SR4001									

## OLDSMOBILE Cutlass Ciera

1990-96	ALL (Incl. Cruiser)	234019	343160		KG5555			SM5043	SM5010	SB104	
1985-89	ALL	234019	343160		KG5555			SM5056	SM5010	SB104	
1984-96	Spring Seat w/ Insulator							SM5229			
1984	ALL w/ HD Susp. ALL w/ Std. Susp.	234019 234002	343160 343160		KG5555 KG5555			SM5056 SM5056	SM5010 SM5010	SB104 SB104	
1982-83	ALL	234002	343160		KG5555			SM5056		SB104	













## OLDSMOBILE Cutlass Supreme (also see STRUT-PLUS)

1990-97	ALL (FWD) w/ HD Susp. ALL (FWD) w/ Std. Susp. Strut Mount Bearing Mount w/ Boot Lower Spring Seat w/ Bearing & Insulator Right Hand Left Hand Lower Spring Seat w/ Insulator Right Hand Left Hand	366004 <sup>20</sup> 366004 <sup>20</sup>	236003 236003					SM5030 SM5029 SM5083	SM5016 SM5016	SB104 SB104	SB106 SB106
								SM5384 SM5383 SM5226 SM5225	SM5277		
1988-89	ALL (FWD) w/ HD Susp. ALL (FWD) w/ Std. Susp. Strut Mount Bearing Mount w/ Boot Lower Spring Seat w/ Bearing & Insulator Right Hand Left Hand Lower Spring Seat w/ Insulator Right Hand Left Hand	366004 <sup>20</sup> 366004 <sup>20</sup>	236003 236003					SM5031 SM5025 SM5083	SM5016 SM5016	SB104 SB104	SB106 SB106
								SM5384 SM5383 SM5226 SM5225	SM5277		
1978-88	ALL (RWD)	343127	343157	KG4513	KG5548						
1968-77	ALL	343127	343157	KG4513	KG5504						

<sup>20</sup> See Special Installation Instructions Appendix A.

Notes de bas de Page 320 - Guia de notas al calce del catalogo Pg. 321  
 Bold part numbers indicate the most comparable KYB product to the original design & performance.  
 (22) For vehicles with Electronic Susp., Leveling Control, and Air Suspensions refer to Appendix C.

# Applications For Pass. Cars, Light Trucks, SUV's, & Vans

VEHICLE MAKE, MODEL & YEAR	  	STRUT & SHOCK		BOOT KITS	
MARQUE, MODELE ET		MOUNTS			
ANNEE DU VEHICULE					
LA MARCA EL MODELO & AÑO					
	 	 	 	 	 

## OLDSMOBILE Cutlass Supreme (also see STRUT-PLUS) (continued)

1967	ALL	343128	343130	KG4515	KG5507						
------	-----	--------	--------	--------	--------	--	--	--	--	--	--

## OLDSMOBILE Cutlass Supreme - STRUT-PLUS

1990-97	ALL (FWD) w/ HD Susp. ALL (FWD) w/ Std. Susp.		SR4026 SR4026								
1988-89	ALL (FWD) w/ HD Susp. ALL (FWD) w/ Std. Susp.		SR4026 SR4026								

## OLDSMOBILE F85

1968-72	ALL	343127	343157	KG4513	KG5504						
1964-67	ALL	343128	343130	KG4515	KG5507						

## OLDSMOBILE Firenza

1987-88	ALL Upper Spring Seat w/ Isolator	Right Hand	231013	343177					SM5007	SM5010	SB104
		Left Hand	231014	343177		KG4536			SM5007	SM5010	SB104
1986	ALL w/ Sealed Struts ALL w/ Rebuildable Struts Upper Spring Seat w/ Isolator	Right Hand	231013	343177					SM5007	SM5010	SB104
		Left Hand	231014	343177		KG4536			SM5007	SM5010	SB104
			366003	343177		KG4536			SM5007	SM5010	SB104
1984-85	ALL Upper Spring Seat w/ Isolator		366003	343177		KG4536			SM5007	SM5010	SB104
1982-83	ALL Upper Spring Seat w/ Isolator		365038	343177		KG4536			SM5007	SM5348	SB104

## OLDSMOBILE Intrigue

1998-02	ALL Universal Strut Mount w/ Boot Upper Spring Seat w/ Insulator Upper Spring Seat Insulator Lower Spring Seat Insulator	Right Hand	334227	334228			734058	734059	SM5143	SM5399	SB127	SB105
		Left Hand	334227	334228			734058	734059	SM5143	SM5398	SM5394	SB127
									SM5470			
									SM5467	SM5440		

## OLDSMOBILE LSS (also see STRUT-PLUS)

1996-99	ALL ALL (For Adapting Air Shock / Strut to Non-Air Suspension)	236007	SR1003 <sup>17</sup> SR4023						SM5057	SM5017	SB104	SB128
---------	--	--------	--------------------------------	--	--	--	--	--	--------	--------	-------	-------

## OLDSMOBILE LSS

1996-99	ALL	SR4022	NA <sup>60</sup>									
---------	-----	--------	------------------	--	--	--	--	--	--	--	--	--

## OLDSMOBILE Omega

1984	ALL	234002	343160		KG5555				SM5056	SM5010	SB104	
1982-83	ALL	234002	343160		KG5555				SM5056		SB104	
1980-81	ALL	234002	343160		KG5555						SB104	
1974-79	ALL	343127	343132	KG4515	KG5506							
1973	ALL	343127	343132	KG4515								

## OLDSMOBILE Regency (Exc. Elec. Adj. Susp.) (also see STRUT-PLUS)

1997-98	ALL w/ Air Leveling System (Exc. Elec. Adj. Susp.)	236007	SR1003 <sup>17</sup>						SM5057	SM5017	SB104	SB128
	ALL w/o Air Leveling System & Elec. Adj. Susp.	236007	235025						SM5057	SM5017	SB104	SB128











<sup>17</sup> Air Strut: A Coil Spring Compressor is not needed

<sup>60</sup> To eliminate the Original Equipment Air Strut, Use STRUT PLUS [SR4023]

Notes de bas de Page 320 - Guia de notas al calce del catalogo Pg. 321

Bold part numbers indicate the most comparable KYB product to the original design & performance.  
(22) For vehicles with Electronic Susp., Leveling Control, and Air Suspensions refer to Appendix C.

# Applications For Pass. Cars, Light Trucks, SUV's, & Vans

VEHICLE MAKE, MODEL & YEAR	<b>GR-2</b>	<b>Gas-a-Just</b>	<b>MonoMax</b> 56XXXX Series	STRUT & SHOCK	
MARQUE, MODELE ET	<b>Excel-G</b>		<b>AGX</b> 7XXXX Series	MOUNTS	BOOT KITS
ANNEE DU VEHICULE	 	 	 	 	 
LA MARCA EL MODELO & AÑO					

## OLDSMOBILE Regency (Exc. Elec. Adj. Susp.) (also see STRUT-PLUS) (continued)

1997-98	ALL (For Adapting Air Shock / Strut to Non-Air Suspension) Spring Seat w/ Insulator Lower Spring Seat Insulator		SR4023					SM5230 SM5412		
---------	---	--	--------	--	--	--	--	------------------	--	--

## OLDSMOBILE Regency (Exc. Elec. Adj. Susp.) - STRUT-PLUS

1997-98	ALL	SR4022	NA <sup>60</sup>							
---------	-----	--------	------------------	--	--	--	--	--	--	--

## OLDSMOBILE Silhouette Mini-Van (Footnote # 22)

1997-04	ALL w/ Rear Level Control ALL w/o Rear Level Control Upper Spring Seat w/ Insulator Upper Spring Seat Insulator Upper Spring Seat Insulator (FWD) Lower Spring Seat Insulator (FWD)	334227 334227	344338		KG54325			SM5143 SM5143 SM5470 SM5467	SM5549 SM5549	SB127 SB127
1994-96	ALL w/o Rear Level Control Spring Seat w/ Insulator		343160		KG5555			SM5043 SM5229	SM5010	SB104
1990-93	ALL w/ Rear Level Control ALL w/o Rear Level Control Spring Seat w/ Insulator	234019 234019	NA <sup>22</sup> 343160		KG5555			SM5043 SM5043 SM5229	SM5010 SM5010	SB104 SB104

## OLDSMOBILE Starfire

1975-80	ALL	343129	343132							
---------	-----	--------	--------	--	--	--	--	--	--	--

## OLDSMOBILE Toronado

1990-92	Strut Mounting Kit Strut Mount Bearing							SM5279 SM5284	SM5275	
1986-89	ALL	236004						SM5114		SB105
1979-85	ALL			KG4531	KG5573 <sup>25</sup>					
1971-78	ALL (Vertical)		343157	KG4501	KG5504					
1966-70	ALL (Vertical)			KG4501						

## OLDSMOBILE Vista Cruiser

1973-77	ALL	343127	343157	KG4513						
1968-72	ALL	343127	343135	KG4513	KG5521					
1964-67	ALL	343128	343135	KG4515	KG5521					

## OPEL 1900 Sedan & S/W

1971-75	ALL	343141								
---------	-----	--------	--	--	--	--	--	--	--	--

## OPEL GT

1969-73	ALL		343039		KG5552					
---------	-----	--	--------	--	--------	--	--	--	--	--

## OPEL Isuzu

1976-79	ALL	343145								
---------	-----	--------	--	--	--	--	--	--	--	--

## OPEL Kadett













1968-72	ALL		343039		KG5552					
---------	-----	--	--------	--	--------	--	--	--	--	--

<sup>22</sup> For vehicles with Electronic Susp., Leveling Control, and Air Suspensions refer to Appendix C.

<sup>25</sup> Eliminates OEM airshocks. See appendix B for special instructions.

<sup>60</sup> To eliminate the Original Equipment Air Strut, Use STRUT PLUS [SR4023]

# Applications For Pass. Cars, Light Trucks, SUV's, & Vans

VEHICLE MAKE, MODEL & YEAR		  	STRUT & SHOCK		BOOT KITS						
MARQUE, MODELE ET			MOUNTS								
ANNEE DU VEHICULE											
LA MARCA EL MODELO & AÑO											
											

## OPEL Manta, Rallye & Sport Coupe

1973-75	ALL (Exc. Station Wagon)	343141									
---------	--------------------------	--------	--	--	--	--	--	--	--	--	--

## PASSPORT I Mark (Canadian Vehicle)

1988-89	ALL (Exc. Lotus Susp.)	Right Hand	232015						SM5297		SB102	
		Left Hand	232016						SM5297		SB102	
	ALL w/ Lotus Susp.	Right Hand	232015						SM5297		SB102	
		Left Hand	232016						SM5297		SB102	

## PASSPORT Impulse (Canadian Vehicle)

1990-92	ALL FWD (Exc. Lotus Susp.)	Right Hand	234041	232033					SM5081		SB102	SB105
		Left Hand	234042	232034					SM5081		SB102	SB105
	AWD	Right Hand	234041						SM5081		SB102	SB105
		Left Hand	234042						SM5081		SB102	SB105
	FWD w/ Lotus Susp.	Right Hand	234041	332076					SM5081		SB102	SB105
		Left Hand	234042	332077					SM5081		SB102	SB105

## PASSPORT Optima (Canadian Vehicle)

1988-93	Strut / Shock Mount								SM5278	SM5010		
1988-91	ALL	365025									SB101	

## PASSPORT Stylus (Canadian Vehicle)

1991-93	ALL (Exc. Lotus Susp.)	Right Hand	234041	232033					SM5081		SB102	SB105
		Left Hand	234042	232034					SM5081		SB102	SB105
	ALL w/ Lotus Susp.	Right Hand	234041	332076					SM5081		SB102	SB105
		Left Hand	234042	332077					SM5081		SB102	SB105

## PEUGEOT 405, 504, 505, 604

1989-91	405	235026	341102								SB101	
10/85-88	505 Sedan										SB117	
1980-9/85	505 Sedan(Exc. Turbo)	364002									SB117	
	505 Station Wagon(Exc. Turbo)	364002									SB105	
1980-83	504 Station Wagon	364002									SB105	
1976-82	604SL, TI, STi	364002									SB105	
1976-79	504, 505 Sedans	364002									SB105	

## PININFARINA Azzura (Spider)

1983-85	ALL	343141	343142									
---------	-----	--------	--------	--	--	--	--	--	--	--	--	--

## PLYMOUTH Acclaim

1989-95	ALL	235902	343164						SM5003			SB103
	Upper Spring Seat Spacer								SM5219			
	Upper Spring Seat								SM5130			
	Lower Spring Seat Insulator								SM5131			

## PLYMOUTH Arrow (Car)

1976-81	ALL		343030									SB103
---------	-----	--	--------	--	--	--	--	--	--	--	--	-------

## PLYMOUTH Arrow (Truck)

1982-83	2WD	344047	344044	KG5433	KG5445							
	4WD	344047	344045	KG5433	KG5438							
1979-81	ALL	344047	344044	KG5433	KG5434							

Notes de bas de Page 320 - Guia de notas al calce del catalogo Pg. 321  
 Bold part numbers indicate the most comparable KYB product to the original design & performance.  
 (22) For vehicles with Electronic Susp., Leveling Control, and Air Suspensions refer to Appendix C.

# Applications For Pass. Cars, Light Trucks, SUV's, & Vans

VEHICLE MAKE, MODEL & YEAR		<b>GR-2</b>		<b>Gas-a-Just</b>		<b>MonoMax</b> 56XXXX Series		STRUT & SHOCK			
MARQUE, MODELE ET		<b>Excel-G</b>				<b>AGX</b> 7XXXXX Series		MOUNTS		BOOT KITS	
ANNEE DU VEHICULE											
LA MARCA EL MODELO & AÑO											

## PLYMOUTH Barracuda

1970-74	ALL			KG4510	KG5512						
1964-69	ALL			KG4509	KG5511						

## PLYMOUTH Belvedere

1962-70	ALL		343159	KG4510	KG5512						
---------	-----	--	--------	--------	--------	--	--	--	--	--	--

## PLYMOUTH Breeze

2000	ALL	344609	344610					SM5263	SM5137	SB108	SB107
1996-99	ALL	344609	344610					SM5262	SM5137	SB108	SB107

## PLYMOUTH Caravelle (FWD)

1/86-88	ALL Upper Spring Seat Spacer Upper Spring Seat Lower Spring Seat Insulator	235902	343164		KG5563			SM5002 SM5219 SM5130 SM5131		SB104	
84-12/85	ALL	234003	343164		KG5563			SM5004		SB104	
1983	ALL	234001	343164		KG5563			SM5004		SB104	

## PLYMOUTH Caravelle (RWD)

1977-89	ALL	343138	343139	KG4528	KG5546						
---------	-----	--------	--------	--------	--------	--	--	--	--	--	--

## PLYMOUTH Champ

1984	w/ Turbo ALL (Exc. Turbo)	233013 365027			KG4192 KG4192			SM5032 SM5032		SB103 SB103	
1982-83	ALL	365027						SM5032		SB103	
1979-81	ALL	365027			KG4192			SM5032		SB103	

## PLYMOUTH Colt (Exc. Colt Vista)

1993-94	ALL (Exc. CA2A Model)	Right Hand Left Hand	234061 234062	341140 341140				SM5109 SM5109	SM5091 SM5091	SB101 SB101	SB107 SB107
1989-92	ALL (Exc. Station Wagon)		235033	341084				SM5063	SM5091	SB101	SB107
1987-90	Station Wagon w/ Power Steering Station Wagon w/o Power Steering		233025 233025					SM5061 SM5062		SB104 SB104	
1987-88	ALL w/ Power Steering (Exc. Station Wagon) ALL w/o Power Steering (Exc. Station Wagon)		233025 233025	342014 342014	KG3200A KG3200A			SM5061 SM5062		SB104 SB104	
1985-86	ALL		233013	342014	KG3200A			SM5316		SB104	
1984	ALL (Exc. Sealed Struts)		365027		KG4192			SM5032		SB103	
1982-83	ALL		365027					SM5032		SB103	
1979-81	ALL (Exc. Station Wagon)		365027		KG4192			SM5032		SB103	
1977-80	Station Wagon			343030	KG4006			SM5315		SB103	

## PLYMOUTH Colt Vista

1992-94	FWD		235032	343262				SM5195	SM5091	SB101	SB108
1986-91	4WD Station Wagon		235050		KG4192			SM5095		SB103	
1984-91	FWD Station Wagon		235006		KG4192			SM5095		SB103	

Notes de bas de Page 320 - Guia de notas al calce del catalogo Pg. 321  
 Bold part numbers indicate the most comparable KYB product to the original design & performance.  
 (22) For vehicles with Electronic Susp., Leveling Control, and Air Suspensions refer to Appendix C.

# Applications For Pass. Cars, Light Trucks, SUV's, & Vans

VEHICLE MAKE, MODEL & YEAR		<b>GR-2</b>		<b>Gas-a-Just</b>		<b>MonoMax</b> 56XXXX Series		STRUT & SHOCK			
MARQUE, MODELE ET		<b>Excel-G</b>				<b>AGX</b> 7XXXXX Series		MOUNTS		BOOT KITS	
ANNEE DU VEHICULE											
LA MARCA EL MODELO & AÑO											

## PLYMOUTH Conquest

1984-8/86	ALL (Exc. Adj. Susp.)	Right Hand	365029						SM5313	SM5310	SB102	SB102
		Left Hand	365029						SM5313	SM5310	SB102	SB102

## PLYMOUTH Cuda

1970-74	ALL			KG4510	KG5512							
---------	-----	--	--	--------	--------	--	--	--	--	--	--	--

## PLYMOUTH Duster

1970-76	ALL			KG4509	KG5511							
---------	-----	--	--	--------	--------	--	--	--	--	--	--	--

## PLYMOUTH Fury

1977-78	ALL (Exc. Police Package)		343158	343139		KG5546						
	ALL w/ Police Package		343158	343159		KG5512						
1975-76	ALL		343158	343159		KG5512						
1974	ALL		343138	343159	KG4528	KG5512						
1965-73	ALL			343159	KG4507	KG5512						
1962-64	ALL			343159	KG4510	KG5512						
1957-61	ALL			343159		KG5511						

## PLYMOUTH GTX

1967-71	ALL			343159	KG4510	KG5512						
---------	-----	--	--	--------	--------	--------	--	--	--	--	--	--

## PLYMOUTH Gran Fury

1982-89	ALL		343138	343139	KG4528	KG5546						
1980-81	ALL		343158	343139		KG5546						
1975-77	ALL		343138	343159	KG4528	KG5512						
1972-73	ALL			343159	KG4507	KG5512						

## PLYMOUTH Horizon

1990	ALL			341037					SM5001	SM5018	SB103	
1981-89	ALL 4 Door		234001	341037					SM5001	SM5018	SB101	
1981-87	ALL 2 Door		234001	341036					SM5001	SM5018	SB101	
1978-80	ALL 2 Door		234001						SM5001	SM5018	SB101	
	ALL 4 Door		234001	341035					SM5001	SM5018	SB101	

## PLYMOUTH Laser

1992-94	AWD		235032	341121			734005	741014	SM5072	SM5091	SB101	SB108
1990-94	FWD		235032	341114			734005	741013	SM5072	SM5091	SB101	SB108











## PLYMOUTH Neon

2000-01	ALL	Right Hand	235627	235628					SM5265	SM5198	SB104	SB101
		Left Hand	235627	235629					SM5265	SM5198	SB104	SB101
	Mount & Spring Seat w/ Insulator								SM5199			
	Upper Spring Seat w/ Insulator								SM5344			
	Lower Spring Seat Insulator								SM5417	SM5464		
1995-99	ALL (Exc. Competition Model)		234902	234901					SM5136	SM5135	SB101	SB103
	Upper Spring Seat								SM5158			
	Lower Spring Seat Insulator									SM5464		

Notes de bas de Page 320 - Guia de notas al calce del catalogo Pg. 321

Bold part numbers indicate the most comparable KYB product to the original design & performance.  
(22) For vehicles with Electronic Susp., Leveling Control, and Air Suspensions refer to Appendix C.

# Applications For Pass. Cars, Light Trucks, SUV's, & Vans

VEHICLE MAKE, MODEL & YEAR	<i><b>GR-2</b></i> <i><b>Excel-G</b></i>	<i><b>Gas-a-Just</b></i>	<i><b>MonoMax</b></i> 56XXXX Series <i><b>AGX</b></i> 7XXXXX Series	STRUT & SHOCK MOUNTS	BOOT KITS
MARQUE, MODELE ET ANNEE DU VEHICULE	 	 	 	 	 
LA MARCA EL MODELO & AÑO					

## PLYMOUTH Prowler

1997-01	ALL	NA	NA							
---------	-----	----	----	--	--	--	--	--	--	--

## PLYMOUTH Reliant

1/86-89	ALL Upper Spring Seat Spacer Upper Spring Seat Lower Spring Seat Insulator	235902	343164		KG5563			SM5003 SM5219 SM5130 SM5131		SB104
84-12/85	ALL	234003	343164		KG5563			SM5004		SB104
1983	ALL	234001	343164		KG5563			SM5002		SB101
1981-82	ALL	234001	343164		KG5563			SM5001		SB101

## PLYMOUTH Roadrunner, Superbird

1976-79	ALL	343138	343139	KG4528	KG5546					
1973-75	ALL	343158	343159		KG5512					
1971-72	ALL			KG4510	KG5512					
1968-70	ALL		343159	KG4510	KG5512					

## PLYMOUTH Sapporo

1981-83	ALL	365029						SM5312		
---------	-----	--------	--	--	--	--	--	--------	--	--

## PLYMOUTH Satellite

1973-74	ALL	343158	343159		KG5512					
1965-72	ALL		343159	KG4510	KG5512					

## PLYMOUTH Scamp

1983	ALL	234001						SM5001		SB101
1971-76	ALL			KG4509	KG5511					

## PLYMOUTH Sundance

1987-94	ALL Upper Spring Seat Spacer Upper Spring Seat Lower Spring Seat Insulator	235902	343164		KG5563			SM5003 SM5219 SM5130 SM5131		SB104
---------	---	--------	--------	--	--------	--	--	--------------------------------------	--	-------

## PLYMOUTH Trail Duster (2WD)

1975-81	ALL	344066	344070	KG5403	KG5413					
---------	-----	--------	--------	--------	--------	--	--	--	--	--

## PLYMOUTH Trail Duster (4WD)

1976-81	ALL	344074	344086	KG5422	KG5423					
1974-75	ALL	344074	344070	KG5422	KG5413					

## PLYMOUTH VIP

1967	ALL		343159	KG4507	KG5512					
------	-----	--	--------	--------	--------	--	--	--	--	--

## PLYMOUTH Valiant

1960-76	ALL			KG4509	KG5511					
---------	-----	--	--	--------	--------	--	--	--	--	--

Notes de bas de Page 320 - Guia de notas al calce del catalogo Pg. 321  
 Bold part numbers indicate the most comparable KYB product to the original design & performance.  
 (2) For vehicles with Electronic Susp., Leveling Control, and Air Suspensions refer to Appendix C.

PASSENGER CARS / VOITURES / AUTOMOVILES  
 LIGHT TRUCKS / CAMIONNETTE / CAMIONES LIGEROS

HEAVY DUTY / MOTORHOME / SERVICE INTENSIF / AUTOCARS ET  
 AUTOCARAVANES / EQUIPOS PESADOS, AUTOBUSES, Y CASAS RODANTES



# Applications For Pass. Cars, Light Trucks, SUV's, & Vans

VEHICLE MAKE, MODEL & YEAR	<b>GR-2</b>	<b>Gas-a-Just</b>	<b>MonoMax</b> 56XXXX Series	STRUT & SHOCK	
MARQUE, MODELE ET	<b>Excel-G</b>		<b>AGX</b> 7XXXX Series	MOUNTS	BOOT KITS
ANNEE DU VEHICULE					
LA MARCA EL MODELO & AÑO					

## PLYMOUTH Volare

1976-80	ALL	343138	343139	KG4528	KG5546						
---------	-----	--------	--------	--------	--------	--	--	--	--	--	--

## PLYMOUTH Voyager Van PB100, PB150

1974-83	ALL	344066	344073	KG5403	KG5418						
---------	-----	--------	--------	--------	--------	--	--	--	--	--	--

## PLYMOUTH Voyager Van PB200, PB250

1974-83	ALL	344066	344073	KG5403	KG5418						
---------	-----	--------	--------	--------	--------	--	--	--	--	--	--

## PLYMOUTH Voyager Van PB300, PB350

1974-83	ALL (Exc. w/ 4000 lb. Front Axle)	344066	344073	KG5403	KG5418						
	ALL w/ 4000 lb. Front Axle		344073	KG5404	KG5418						

## PLYMOUTH Voyager, Grand Voyager Mini-Van (also see STRUT-PLUS)

1997-00	ALL w/ Nivomat Rear Susp.	334188	SR2001					SM5112		SB126	
1996-00	ALL (Exc. AWD Model) (Exc. Nivomat Rear Susp.) Upper Spring Seat Lower Spring Seat Insulator	334188	344080		KG5457			SM5112		SB126	
								SM5157 SM5410			
1986-95	ALL (Incl. AWD) Upper Spring Seat Spacer Upper Spring Seat Lower Spring Seat Insulator	235901	344080		KG5457			SM5003 SM5219 SM5130 SM5131		SB126	
1984-85	ALL	234004	344080		KG5457			SM5004		SB126	

## PLYMOUTH Voyager, Grand Voyager Mini Van - STRUT-PLUS

1996-00	ALL V6 Eng. (Exc. Nivomat Load Leveling Rear Susp.) Right Hand Left Hand	SR4020 SR4021									
	ALL V6 Eng. w/ Nivomat Rear Susp. (Exc. AWD) Right Hand Left Hand	SR4020 SR4021									
1987-95	ALL V6 Eng. (Incl. AWD)	SR4019									

## PONTIAC 6000

1990-91	ALL (Exc. AWD)	234019	343160		KG5555			SM5043	SM5010	SB104	
1990	AWD	234019						SM5043	SM5010	SB104	
1989	AWD	234019						SM5056	SM5010	SB104	
1985-89	ALL (Exc. STE)	234019	343160		KG5555			SM5056	SM5010	SB104	
1984-91	Spring Seat w/ Insulator							SM5229			
1984-88	STE Model (Exc. AWD)	234019	343160 <sup>22</sup>		KG5555 <sup>22</sup>			SM5056	SM5010	SB104	
1984	ALL (Exc. HD Susp. & STE)	234002	343160		KG5555			SM5056	SM5010	SB104	
	ALL w/ HD Susp. (Exc. STE)	234019	343160		KG5555			SM5056	SM5010	SB104	
1982-83	ALL	234002	343160		KG5555			SM5056		SB104	

## PONTIAC Acadian (Canadian Vehicle)

1976-87	ALL	343145	343147								
---------	-----	--------	--------	--	--	--	--	--	--	--	--

## PONTIAC Astre

1975-77	ALL	343129	343132								
---------	-----	--------	--------	--	--	--	--	--	--	--	--

<sup>22</sup> For vehicles with Electronic Susp., Leveling Control, and Air Suspensions refer to Appendix C.

Notes de bas de Page 320 - Guia de notas al calce del catalogo Pg. 321

Bold part numbers indicate the most comparable KYB product to the original design & performance.

(22) For vehicles with Electronic Susp., Leveling Control, and Air Suspensions refer to Appendix C.

# Applications For Pass. Cars, Light Trucks, SUV's, & Vans

VEHICLE MAKE, MODEL & YEAR	<b>GR-2</b>		<b>Gas-a-Just</b>		<b>MonoMax</b> 56XXXX Series		STRUT & SHOCK			
MARQUE, MODELE ET	<b>Excel-G</b>				<b>AGX</b> 7XXXXX Series		MOUNTS		BOOT KITS	
ANNEE DU VEHICULE										
LA MARCA EL MODELO & AÑO										

## PONTIAC Aztek (AWD)

2001-05	ALL (Exc. Rear Air Leveling) Upper Spring Seat w/ Insulator Upper Spring Seat Insulator Lower Spring Seat Insulator	335044					SM5143 SM5470 SM5467 SM5437		SB127	
---------	--	--------	--	--	--	--	--------------------------------------	--	-------	--

## PONTIAC Aztek (FWD)

2001-05	ALL (Exc. Rear Air Leveling) Upper Spring Seat Insulator Upper Spring Seat w/ Insulator Lower Spring Seat Insulator	335044	344338				SM5143 SM5467 SM5470 SM5437	SM5549	SB127	
---------	--	--------	--------	--	--	--	--------------------------------------	--------	-------	--

## PONTIAC Bonneville (Exc. Elect. Adj. Susp.) (also see STRUT-PLUS)

2002-05	ALL Upper Spring Seat w/ Insulator Lower Spring Seat Insulator	335037	SR1002 <sup>16</sup>				SM5276 SM5435 SM5437	SM5334	SB101	
2000-01	ALL Upper Spring Seat w/ Insulator Lower Spring Seat Insulator	335037	SR1002 <sup>16</sup>				SM5276 SM5436 SM5437	SM5334	SB101	
1991-99	ALL w/ Self Leveling Rear ALL w/o Self Leveling Rear ALL (For Adapting Air Shock / Strut to Non-Air Suspension) Upper Spring Seat w/ Insulator	236007 236007	SR1003 235025 SR4023				SM5057 SM5057	SM5017 SM5017	SB104 SB104	SB128 SB128
1990-99	Lower Spring Seat Insulator Fits the 2nd Design Spring Seat w/o Bracket						SM5412			
Late 90-96	Strut Mount Bearing (Exc. FE2 or FW1 Susp.)						SM5284			
1990	Early Design Front Struts (w/ SpringGuard) w/ Self-Level Rear Early Design Front Struts (w/ SpringGuard) w/o Self-Level Rear Late Design Front Struts (w/o SpringGuard) w/ Self-Level Rear Late Design Front Struts (w/o SpringGuard) w/o Self-Level Rear ALL (For Adapting Air Shock / Strut to Non-Air Suspension)	236002 236002 236007 236007	SR1003 <sup>17</sup> 235025 SR1003 <sup>17</sup> 235025 SR4023				SM5026 SM5026 SM5057 SM5057	SM5017 SM5017 SM5017 SM5017	SB105 SB105 SB104 SB104	SB104
87-Early 90	Strut Mounting Kit Strut Mount Bearing Upper Spring Seat w/ Isolator						SM5281 SM5284 SM5350			
1987-90	Lower Spring Seat Insulator Fits the 1st Design Spring Seat w/ bracket						SM5411			
1987-89	ALL w/ Self Leveling Rear ALL w/o Self Leveling Rear ALL (For Adapting Air Shock / Strut to Non-Air Suspension)	236002 236002	SR1003 <sup>17</sup> 235025 SR4023				SM5026 SM5026	SM5017 SM5017	SB105 SB105	SB104
1982-86	Bonneville Model G	343127	343157	KG4513	KG5548					
1971-81	Sedan & Coupe Station Wagon	343127 343127	343130 343157	KG4515 KG4515	KG5507 KG5504					
1963-70	ALL	343128	343130	KG4515	KG5507					
1961-62	ALL	343128		KG4550						
1958-60	Sedan & Coupe (Exc. Air Susp.) Station Wagon (Exc. Air Susp.)	343128 343128	344045 344044	KG4550 KG4550						

<sup>16</sup> Box contains two shocks













<sup>17</sup> Air Strut: A Coil Spring Compressor is not needed

Notes de bas de Page 320 - Guia de notas al calce del catalogo Pg. 321

Bold part numbers indicate the most comparable KYB product to the original design & performance.

(22) For vehicles with Electronic Susp., Leveling Control, and Air Suspensions refer to Appendix C.

# Applications For Pass. Cars, Light Trucks, SUV's, & Vans

VEHICLE MAKE, MODEL & YEAR	  	STRUT & SHOCK		BOOT KITS	
MARQUE, MODELE ET		MOUNTS			
ANNEE DU VEHICULE					
LA MARCA EL MODELO & AÑO	 	 	 	 	 

## PONTIAC Bonneville (Exc. Adj. Susp.) - STRUT-PLUS

1991-99	Bonneville w/ Self Leveling Rear Bonneville w/o Self Leveling Rear	SR4022 SR4022	NA <sup>60</sup> SR4023							
1990	Bonneville Late Design Front Struts (w/o SpringGuard) w/ Self-Level Rear Bonneville Late Design Front Struts (w/o SpringGuard) w/o Self-Level Rear Bonneville Early Design Front Struts (w/ SpringGuard) w/ Self-Level Rear Bonneville Early Design Front Struts (w/ SpringGuard) w/o Self-Level Rear	SR4022 SR4022	NA <sup>60</sup> SR4023 NA <sup>60</sup> SR4023							
1987-89	Bonneville w/ Self Leveling Rear Bonneville w/o Self Leveling Rear		NA <sup>60</sup> SR4023							

## PONTIAC Catalina

1971-81	Sedan & Coupe Station Wagon	343127 343127	343130 343157	KG4515 KG4515	KG5507 KG5504					
1971-72	Convertible	343127	343130	KG4515	KG5507					
1963-70	ALL	343128	343130	KG4515	KG5507					
1958-62	ALL	343128		KG4550						

## PONTIAC Fiero

1988	ALL	343127		KG4513				SM5190		SB103
1984-87	ALL		234005	KG4538				SM5190		SB103

## PONTIAC Firebird, Trans Am

1993-02	ALL V6 ALL V8	Right Hand Left Hand Right Hand Left Hand	341356 341356 341356 341356	343211 343211 343211 343211	KG9310 KG9310 KG9310 KG9310	KG5562 KG5562 KG5562 KG5562	741034 741034 741034 741034	743019 743019 743019 743019	SM5119 SM5118 SM5119 SM5118	SB103 SB103 SB103 SB103
1982-92	ALL	Right Hand Left Hand	236001 236001	343211 343211		KG5562 KG5562	735001 735001	743019 743019	SM5028 SM5027	
1970-81	ALL		343128	343131	KG4515	KG5526				
1968-69	ALL		343127	343135	KG4515	KG5521				
1967	ALL Shock (Sleeve) Adapter Kit		343127	343135 <sup>7</sup> KIT107	KG4515	KG5524				

## PONTIAC Firefly (Canadian Vehicle)

1989-92	ALL	Right Hand Left Hand	232025 232026	232027 232027					SM5188 SM5188	SM5189 SM5189	SB103 SB103	SB101 SB101
1987-88	ALL	Right Hand Left Hand	232019 232020	341075 341075								
1985-86	ALL	Right Hand Left Hand		342012 342012								

## PONTIAC G3

2009	ALL	Right Hand Left Hand	333417 333418	343423 343423					SM5451 SM5451	SM5452 SM5452	SB101 SB101	SB107 SB107
------	-----	-------------------------	------------------	------------------	--	--	--	--	------------------	------------------	----------------	----------------













## PONTIAC G5

2009	ALL			349043					SM5513		SB101	
2007-08	ALL	Right Hand Left Hand	339084 339085	349043 349043					SM5513 SM5513		SB101 SB101	

<sup>60</sup> To eliminate the Original Equipment Air Strut, Use STRUT PLUS [SR4023]

<sup>7</sup> Use Kit #107

# Applications For Pass. Cars, Light Trucks, SUV's, & Vans

VEHICLE MAKE, MODEL & YEAR	  	STRUT & SHOCK		BOOT KITS	
MARQUE, MODELE ET		MOUNTS			
ANNEE DU VEHICULE					
LA MARCA EL MODELO & AÑO					
	 	 	 	 	 

## PONTIAC G6

2010	ALL	Right Hand Left Hand	339051 339052	349008 349008					SM5471 SM5447	SM5476 SM5476	SB101 SB101	
2006-09	Convertible Sedan & Coupe	Right Hand Left Hand Right Hand Left Hand	339051 339052 339051 339052	349008 349008					SM5471 SM5447 SM5471 SM5447	SM5476 SM5476 SM5476 SM5476	SB101 SB101 SB101 SB101	
2005	ALL	Right Hand Left Hand	339051 339052	349008 349008					SM5471 SM5447	SM5476 SM5476	SB101 SB101	

## PONTIAC G8

2008-09	ALL								SM5146		SB103	
---------	-----	--	--	--	--	--	--	--	--------	--	-------	--

## PONTIAC GTO

2004-06	ALL	Right Hand Left Hand	334680 334681	341670 341670					SM5285 SM5285		SB103 SB103	
1974	ALL		343127	343132	KG4515	KG5506						
1968-73	ALL		343127	343157	KG4513	KG5504						
1964-67	ALL (Exc. HD Susp.) w/ HD Susp.		343128 343128	343130 343130	KG4515 KG4515	KG5507 KG5504						

## PONTIAC Grand Am (also see STRUT-PLUS)

1999-05	ALL Upper Spring Seat Insulator Lower Spring Seat Insulator		334229	334295			734056	734057	SM5146 SM5438 SM5420	SM5145 SM5524	SB104	SB101
1995-98	ALL w/o Swaybar Bracket ALL w/ Swaybar Bracket Strut Mount Bearing Upper Spring Seat w/ Insulator Lower Spring Seat Insulator	Right Hand Left Hand	235604 235605	343402 343402 343402		KG4552 KG4552 KG5576			SM5142 SM5142 SM5142 SM5284 SM5228 SM5431	SM5010 SM5010 SM5010	SB103 SB103 SB103	
1992-94	ALL w/o Swaybar Bracket ALL w/ Swaybar Bracket (Exc. Adj. Susp.) Strut Mount Bearing Upper Spring Seat w/ Isolator Lower Spring Seat Insulator	Right Hand Left Hand	235604 235605	343177 343177 343177		KG4536 KG4536 KG4536			SM5073 SM5073 SM5073 SM5284 SM5349 SM5431	SM5010 SM5010 SM5010	SB104 SB104 SB104	
1987-91	ALL Upper Spring Seat w/ Isolator Lower Spring Seat Insulator	Right Hand Left Hand	231013 231014	343177 343177		KG4536 KG4536			SM5007 SM5007 SM5348 SM5431	SM5010 SM5010	SB104 SB104	
1985-86	ALL w/ Sealed Struts ALL w/ Rebuildable Struts Upper Spring Seat w/ Isolator Lower Spring Seat Insulator	Right Hand Left Hand	231013 231014 366003 <sup>18</sup>	343177 343177 343177		KG4536 KG4536 KG4536			SM5007 SM5007 SM5007 SM5348 SM5431	SM5010 SM5010 SM5010	SB104 SB104 SB104	
1978-80	ALL		343127	343157	KG4513	KG5548						
1973-75	ALL		343127	343157	KG4513	KG5504						

## PONTIAC Grand Am (FWD) - STRUT-PLUS

1999-05	ALL		SR4001	SR4037								
---------	-----	--	--------	--------	--	--	--	--	--	--	--	--

<sup>18</sup> Strut must be cut to install cartridge. Check strut for a cut line groove (20mm from strut top). If no cut line groove is found, do not cut strut open as there are no threads inside. The complete strut must be replaced.

# Applications For Pass. Cars, Light Trucks, SUV's, & Vans

VEHICLE MAKE, MODEL & YEAR										
MARQUE, MODELE ET	<b>GR-2</b>	<b>Gas-a-Just</b>	<b>MonoMax</b> 56XXXX Series	STRUT & SHOCK						
ANNEE DU VEHICULE	<b>Excel-G</b>		<b>AGX</b> 7XXXX Series	MOUNTS						BOOT KITS
LA MARCA EL MODELO & AÑO										

## PONTIAC Grand LeMans

1978-83	ALL	343127	343157	KG4513	KG5548						
1975-77	Sedan & Coupe Station Wagon	343127 343127	343157 343157	KG4513 KG4513	KG5504						

## PONTIAC Grand Prix (also see STRUT-PLUS)

2004-08	ALL (Exc. GXP)	Right Hand	339089	334228					SM5143	SM5399	SB127	SB104
		Left Hand	339089	334228					SM5143	SM5398	SB127	SB104
	Upper Spring Seat w/ Insulator								SM5470			
	Upper Spring Seat Insulator								SM5467			
	Lower Spring Seat Insulator								SM5437	SM5440		
1999-03	ALL	Right Hand	339015	334228			734058	734059	SM5143	SM5399	SB127	SB105
		Left Hand	339015	334228			734058	734059	SM5143	SM5398	SB127	SB105
	Upper Spring Seat w/ Insulator								SM5470			
	Upper Spring Seat Insulator								SM5467			
	Lower Spring Seat Insulator								SM5437	SM5440		
1997-08	Universal Strut Mount									SM5144		
	Universal Strut Mount w/ Boot									SM5394		
1997-98	ALL	Right Hand	334227	334228			734058	734059	SM5143	SM5399	SB127	SB105
		Left Hand	334227	334228			734058	734059	SM5143	SM5398	SB127	SB105
	Upper Spring Seat w/ Insulator								SM5470			
	Upper Spring Seat Insulator								SM5467			
	Lower Spring Seat Insulator								SM5437	SM5440		
1990-96	ALL (FWD) w/ HD Susp.		366004 <sup>20</sup>	236003					SM5030	SM5016	SB104	SB106
	ALL (FWD) w/ Std. Susp.		366004 <sup>20</sup>	236003					SM5029	SM5016	SB104	SB106
	Strut Mount Bearing								SM5083			
	Mount w/ Boot									SM5277		
	Lower Spring Seat w/ Bearing & Insulator											
		Right Hand							SM5384			
		Left Hand							SM5383			
	Lower Spring Seat w/ Insulator	Right Hand							SM5226			
		Left Hand							SM5225			
1988-89	ALL (FWD) w/ HD Susp.		366004 <sup>20</sup>	236003					SM5031	SM5016	SB104	SB106
	ALL (FWD) w/ Std. Susp.		366004 <sup>20</sup>	236003					SM5025	SM5016	SB104	SB106
	Strut Mount Bearing								SM5083			
	Mount w/ Boot									SM5277		
	Lower Spring Seat w/ Bearing & Insulator											
		Right Hand							SM5384			
		Left Hand							SM5383			
	Lower Spring Seat w/ Insulator	Right Hand							SM5226			
		Left Hand							SM5225			
1978-87	ALL		343127	343157	KG4513	KG5548						
1969-77	ALL		343127	343157	KG4513	KG5504						
1963-68	ALL		343128	343130	KG4515							
1962	ALL		343128		KG4515							

## PONTIAC Grand Prix - STRUT-PLUS

2006-07	ALL (Exc. GT, GXP)	Right Hand		SR4003								
		Left Hand		SR4004								
2004-05	ALL (Exc. GTP & GXP)	Right Hand		SR4003								
		Left Hand		SR4004								
1997-03	ALL (Exc. GTP)	Right Hand	SR4002	SR4003								
		Left Hand	SR4002	SR4004								
1990-96	ALL (FWD) w/ HD Susp.			SR4026								
	ALL (FWD) w/ Std. Susp.			SR4026								
1988-89	ALL (FWD) w/ HD Susp.			SR4026								
	ALL (FWD) w/ Std. Susp.			SR4026								

<sup>20</sup> See Special Installation Instructions Appendix A.

Notes de bas de Page 320 - Guia de notas al calce del catalogo Pg. 321  
 Bold part numbers indicate the most comparable KYB product to the original design & performance.  
 (22) For vehicles with Electronic Susp., Leveling Control, and Air Suspensions refer to Appendix C.

# Applications For Pass. Cars, Light Trucks, SUV's, & Vans

VEHICLE MAKE, MODEL & YEAR		<b>GR-2</b>		<b>Gas-a-Just</b>		<b>MonoMax</b> 56XXXX Series		STRUT & SHOCK			
MARQUE, MODELE ET		<b>Excel-G</b>				<b>AGX</b> 7XXXXX Series		MOUNTS		BOOT KITS	
ANNEE DU VEHICULE											
LA MARCA EL MODELO & AÑO											

## PONTIAC Grand Safari

1971-78	ALL	343127	343157	KG4515	KG5504						
---------	-----	--------	--------	--------	--------	--	--	--	--	--	--

## PONTIAC Grandville

1971-75	ALL	343127	343157								
---------	-----	--------	--------	--	--	--	--	--	--	--	--

## PONTIAC J2000

1985-86	ALL w/ Sealed Struts	Right Hand	231013	343177		KG4536			SM5007	SM5010	SB104
		Left Hand	231014	343177		KG4536			SM5007	SM5010	SB104
	ALL w/ Rebuildable Struts		366003 <sup>18</sup>	343177		KG4536			SM5007	SM5010	SB104
1984	ALL		366003 <sup>18</sup>	343177		KG4536			SM5007	SM5010	SB104
1982-83	ALL		365038 <sup>18</sup>	343177		KG4536			SM5007		SB104

## PONTIAC Laurentian (Canadian Vehicle)

1971-81	Sedan & Coupe	343127	343130	KG4515	KG5507						
	Station Wagon	343127	343157	KG4515	KG5504						

## PONTIAC Lemans

1988-93	FWD	365025			KG4543				SM5278		SB101
1978-81	ALL	343127	343157	KG4513	KG5548						
1973-77	Sedan & Coupe	343127	343157	KG4513	KG5504						
	Station Wagon	343127	343157	KG4513							
1968-72	ALL	343127	343157	KG4513	KG5504						
1964-67	ALL (Exc. HD Susp.)	343128	343130	KG4515	KG5507						
	w/ HD Susp.	343128	343130	KG4515	KG5504						

## PONTIAC Montana Mini-Van

1999-05	ALL w/ Rear Level Control	334227			KG54325				SM5143		SB127
	ALL w/o Rear Level Control	334227	344338						SM5143		SB127
	Upper Spring Seat w/ Insulator								SM5470		
	Upper Spring Seat Insulator								SM5467		
	Upper Spring Seat Insulator (FWD)									SM5549	
	Lower Spring Seat Insulator								SM5437		
	Lower Spring Seat Insulator (FWD)									SM5549	

## PONTIAC Montana SV6 Mini-Van

2005-09	AWD	335061			KG54325				SM5143		SB127
	FWD (Exc. Self Leveling Rear Susp.)	335061	344338						SM5143		SB127
	Upper Spring Seat w/ Insulator								SM5470		
	Upper Spring Seat Insulator								SM5467		
	Upper Spring Seat Insulator (FWD)									SM5549	
	Lower Spring Seat Insulator								SM5437		
	Lower Spring Seat Insulator (FWD)									SM5549	

## PONTIAC Parisienne





1971-86	Sedan	343127	343130	KG4515	KG5507						
	Station Wagon	343127	343157	KG4515	KG5504						

## PONTIAC Phoenix

1984	ALL	234002	343160		KG5555				SM5056	SM5010	SB104
	Spring Seat w/ Insulator								SM5229		
1980-83	ALL	234002	343160		KG5555				SM5056		SB104
1977-79	ALL	343127	343132	KG4515	KG5506						

<sup>18</sup> Strut must be cut to install cartridge. Check strut for a cut line groove (20mm from strut top). If no cut line groove is found, do not cut strut open as there are no threads inside. The complete strut must be replaced.

# Applications For Pass. Cars, Light Trucks, SUV's, & Vans

VEHICLE MAKE, MODEL & YEAR		<b>GR-2</b> <i>Excel-G</i>		<b>Gas-a-Just</b>		<b>MonoMax</b> 56XXXX Series <b>AGX</b> 7XXXX Series		STRUT & SHOCK MOUNTS		BOOT KITS	
MARQUE, MODELE ET ANNEE DU VEHICULE											
LA MARCA EL MODELO & AÑO											

## PONTIAC Pursuit (Canadian Vehicle)

2005-06	ALL	Right Hand Left Hand	339084 339085	349043 349043					SM5513 SM5513		SB101 SB101
---------	-----	-------------------------	------------------	------------------	--	--	--	--	------------------	--	----------------

## PONTIAC Safari

1987-90	ALL		343127	343157	KG4515	KG5504					
1963-70	ALL		343128	343130							
1961-62	ALL		343128		KG4550						

## PONTIAC Solstice

2006-08	ALL		NA	NA							
---------	-----	--	----	----	--	--	--	--	--	--	--

## PONTIAC Sunbird

1992-94	ALL	Right Hand Left Hand	231013 231014	343177 343177		KG4536 KG4536			SM5033 SM5033	SM5010 SM5010	SB104 SB104
1987-91	ALL	Right Hand Left Hand	231013 231014	343177 343177		KG4536 KG4536			SM5007 SM5007	SM5010 SM5010	SB104 SB104
1985-86	ALL w/ Sealed Struts ALL w/ Rebuildable Struts	Right Hand Left Hand	231013 231014 366003 <sup>18</sup>	343177 343177 343177		KG4536 KG4536 KG4536			SM5007 SM5007 SM5007	SM5010 SM5010 SM5010	SB104 SB104 SB104
1984	ALL		366003 <sup>18</sup>	343177		KG4536			SM5007	SM5010	SB104
1982-94	Upper Spring Seat w/ Insulator								SM5348		
1982-83	ALL		365038 <sup>18</sup>	343177		KG4536			SM5007		SB104
1976-80	ALL		343129	343132							

## PONTIAC Sunburst (Canadian Vehicle)

1985-88	ALL	Right Hand Left Hand	232015 232016			KG4542 KG4542			SM5297		SB102 SB102
---------	-----	-------------------------	------------------	--	--	------------------	--	--	--------	--	----------------

## PONTIAC Sunfire (also see STRUT-PLUS)

1999-05	ALL Lower Spring Seat Insulator		334316	341244			734038	741061	SM5283 SM5418	SM5147	SB101
1995-98	ALL Strut Mount Bearing Upper Spring Seat w/ Insulator Lower Spring Seat Insulator		334316	341244			734038	741061	SM5142 SM5284 SM5419 SM5418	SM5147	SB101

## PONTIAC Sunfire - STRUT-PLUS

1995-05	ALL		SR4024	SR4025							
---------	-----	--	--------	--------	--	--	--	--	--	--	--

## PONTIAC Sunrunner (Canadian Vehicle)

1993-98	ALL (Exc. ABS) ALL w/ 4 Wheel ABS	Right Hand Left Hand	235035 235036	343247 343247 343247		KG4745A KG4745A KG4745A			SM5082 SM5082 SM5082		
---------	--------------------------------------	-------------------------	------------------	----------------------------	--	-------------------------------	--	--	----------------------------	--	--

## PONTIAC T1000

1981-87	ALL		343145	343147							
---------	-----	--	--------	--------	--	--	--	--	--	--	--

## PONTIAC Tempest

1968-70	ALL		343127	343157	KG4513	KG5504					
1964-67	ALL (Exc. HD Susp.) w/ HD Susp.		343128 343128	343130 343130	KG4515 KG4515	KG5507 KG5504					

<sup>18</sup> Strut must be cut to install cartridge. Check strut for a cut line groove (20mm from strut top). If no cut line groove is found, do not cut strut open as there are no threads inside. The complete strut must be replaced.

# Applications For Pass. Cars, Light Trucks, SUV's, & Vans

VEHICLE MAKE, MODEL & YEAR		<b>GR-2</b>		<b>Gas-a-Just</b>		<b>MonoMax</b> 56XXXX Series		STRUT & SHOCK			
MARQUE, MODELE ET		<b>Excel-G</b>				<b>AGX</b> 7XXXX Series		MOUNTS		BOOT KITS	
ANNEE DU VEHICULE											
LA MARCA EL MODELO & AÑO											

## PONTIAC Tempest (Canadian Vehicle)

1992-94	ALL	Right Hand Left Hand	235604 235605	343177 343177		KG4536 KG4536			SM5073 SM5073	SM5010 SM5010	SB103 SB103	
1987-91	ALL	Right Hand Left Hand	231013 231014	343177 343177		KG4536 KG4536			SM5280 SM5280	SM5010 SM5010	SB104 SB104	

## PONTIAC Torrent

2007-09	ALL (Exc. Sport Susp.)			345055		554353						
2006	ALL	Right Hand Left Hand	339058 339057	345055 345055		554353 554353					SB102 SB102	
	Lower Spring Seat Insulator								SM5550			

## PONTIAC Trans Sport Mini-Van (Footnote # 22)

1997-98	ALL w/ Rear Level Control ALL w/o Rear Level Control Upper Spring Seat w/ Insulator Upper Spring Seat Insulator		334227 334227	344338		KG54325			SM5143 SM5143 SM5470 SM5467		SB127 SB127	
1994-96	ALL w/o Rear Level Control Spring Seat w/ Insulator			343160		KG5555			SM5043 SM5229	SM5010	SB104	
1990-93	ALL w/ Rear Level Control ALL w/o Rear Level Control Spring Seat w/ Insulator		234019 234019	343160		KG5555			SM5043 SM5043 SM5229	SM5010 SM5010	SB104 SB104	

## PONTIAC Ventura

1974-77	ALL		343127	343132	KG4515	KG5506						
1973	ALL (Exc. HD Susp.) w/ HD Susp.		343127 343127	343132 343157	KG4515 KG4515	KG5504						
1971-72	w/ Multi Leaf Spring w/ Single Leaf Spring		343127 343127	343157 343132	KG4515 KG4515	KG5504						

## PONTIAC Vibe (AWD)

2009-10	ALL									SM5382		SB108
2003-06	ALL	Right Hand Left Hand	235703 235704	344613 344613					SM5215 SM5215	SM5382 SM5382	SB102 SB102	SB108 SB108

## PONTIAC Vibe (FWD)

2009-10	ALL									SM5382		SB108
2007-08	ALL								SM5215	SM5382	SB102	SB108
2003-06	ALL	Right Hand Left Hand	235703 235704	344612 344612					SM5215 SM5215	SM5382 SM5382	SB102 SB102	SB108 SB108

## PONTIAC Wave (Canadian Vehicle)

2005-08	ALL		NA	343423					SM5451	SM5452	SB101	SB107
---------	-----	--	----	--------	--	--	--	--	--------	--------	-------	-------









## PORSCHE 911, 912, 930

1985-7/88	ALL					KG5542						
1972-84	ALL (Exc. Bilstein Equipped) Bilstein Equipped		361004			KG5542 KG5542						
1969-71	ALL (Exc. 911E w/ Self Leveling System)		361004			KG5543						
1965-68	ALL					KG5543						

Notes de bas de Page 320 - Guia de notas al calce del catalogo Pg. 321  
 Bold part numbers indicate the most comparable KYB product to the original design & performance.  
 (22) For vehicles with Electronic Susp., Leveling Control, and Air Suspensions refer to Appendix C.



# Applications For Pass. Cars, Light Trucks, SUV's, & Vans

VEHICLE MAKE, MODEL & YEAR		<b>GR-2</b>		<b>Gas-a-Just</b>		<b>MonoMax</b> 56XXXX Series		STRUT & SHOCK			
MARQUE, MODELE ET		<b>Excel-G</b>				<b>AGX</b> 7XXXXX Series		MOUNTS		BOOT KITS	
ANNEE DU VEHICULE		 		 		 		 		 	
LA MARCA EL MODELO & AÑO											

## PORSCHE 914

1969-76	ALL	361004			KG9003						SB108
---------	-----	--------	--	--	--------	--	--	--	--	--	-------

## PORSCHE 924, 944, 924S

1989-91	944				KG4544						SB102
1986-88	924S	363014			KG4544						SB102
1/85-88	944 (Exc. Turbo & Sealed Strut)	363014			KG4544						SB102
1985-88	944 Turbo (Exc. M474 Sport Susp.)	363014			KG4544						SB102
1983-12/84	944	363014			KG4529						SB102
1976-83	924 (Exc. Sport Susp.)	363014			KG4529						SB102

## PORSCHE Boxster

1997-08	ALL	NA	NA								
---------	-----	----	----	--	--	--	--	--	--	--	--

## RENAULT Alliance

1983-87	ALL	234017	343152		KG4541			SM5331			
---------	-----	--------	--------	--	--------	--	--	--------	--	--	--

## RENAULT Encore

1984-86	ALL	234017	343152		KG4541			SM5331			
---------	-----	--------	--------	--	--------	--	--	--------	--	--	--

## RENAULT Fuego

1982-85	ALL	341047	343180								
---------	-----	--------	--------	--	--	--	--	--	--	--	--

## RENAULT LeCar (R5)

1972-83	ALL				KG4533	KG4534					
---------	-----	--	--	--	--------	--------	--	--	--	--	--

## RENAULT Medallion

1987	Sedan		343220								SB101
------	-------	--	--------	--	--	--	--	--	--	--	-------

## RENAULT R18i

1984-86	ALL	341047	343180								
1981-83	ALL		343180								

## RENAULT Sportwagon

1984-86	Sportwagon	341047	343180								
---------	------------	--------	--------	--	--	--	--	--	--	--	--

## SAAB 9-2X

2005-06	ALL							SM5361	SM5422	SB101	SB102
---------	-----	--	--	--	--	--	--	--------	--------	-------	-------













## SAAB 9-3 Series

2009	Strut / Shock Boot									SB101	
2007-08	ALL	Right Hand Left Hand	334688 <sup>70</sup> 334689 <sup>70</sup>							SB101 SB101	
2004-09	Lower Spring Seat Insulator w/ Bumper (Convertible)								SM5354		
2003-06	ALL	Right Hand Left Hand	334688 <sup>70</sup> 334689 <sup>70</sup>	349007 349007					SM5354	SB101 SB101	
2003	Lower Spring Seat Insulator w/ Bumper (Sedan & Wagon)										
2003	Convertible Strut Mount w/ Bearing							SM5339 SM5340			

<sup>70</sup> New Part Number, Available 2nd Quarter 2011

Notes de bas de Page 320 - Guia de notas al calce del catalogo Pg. 321  
 Bold part numbers indicate the most comparable KYB product to the original design & performance.  
 (22) For vehicles with Electronic Susp., Leveling Control, and Air Suspensions refer to Appendix C.

# Applications For Pass. Cars, Light Trucks, SUV's, & Vans

VEHICLE MAKE, MODEL & YEAR	  	STRUT & SHOCK		BOOT KITS	
MARQUE, MODELE ET		MOUNTS			
ANNEE DU VEHICULE					
LA MARCA EL MODELO & AÑO					
	 	 	 	 	 

## SAAB 9-3 Series (continued)

2003	Strut Mount Bearing							SM5338			
2001-02	Upper Spring Seat Insulator w/ Bumper 3 Dr., 5 Dr. w/o Viggen (Rear Right) Upper Spring Seat Insulator w/ Bumper 3 Dr., 5 Dr. w/o Viggen (Rear Left) Upper Spring Seat Insulator w/ Bumper, Convertible w/o Viggen (Rear Right) Upper Spring Seat Insulator w/ Bumper, Convertible w/o Viggen (Rear Left)								SM5353 SM5352 SM5353 SM5352		
1999-02	ALL Strut Mount w/ Bearing Strut Mount Bearing Upper Spring Seat Insulator w/ Bumper w/ Viggen (Rear Left) Upper Spring Seat Insulator w/ Bumper w/ Viggen (Rear Right)	366012	343270					SM5339 SM5340 SM5338	SM5352 SM5353	SB101	

## SAAB 9-5 Series

2007-09	ALL							SM5335		SB101	
2006	ALL	334679						SM5335		SB101	
2002-09	ALL w/ Automatic Rear Air Leveling System ALL w/o Air Leveling System Strut Mount w/ Bearing							SM5336			SB107 SB108
2002-05	ALL (Exc. Sport Susp.)	334679	341847 <sup>77</sup>					SM5335		SB101	
1999-09	Strut Mount Bearing							SM5338			
1999-01	ALL (Exc. Sport Susp.) Strut Mount w/ Bearing	335921	341847 <sup>77</sup>					SM5335 SM5336		SB101	SB108

## SAAB 900 Series

1994-98	ALL Strut Mount w/ Bearing	366010			KG4741			SM5337 SM5172			
1979-93	ALL	343023	343024	KG4532	KG5558						

## SAAB 9000 Series

1987-98	ALL (Exc. Self Leveling Rear) From VIN# -H1015470 & VIN# - H8000556	235034			KG4549			SM5103		SB105	
1987-93	ALL w/ Self Leveling Rear From VIN# - H1015470 & VIN# - H8000556	235034			KG4549 <sup>12</sup>			SM5103		SB105	
1986-87	ALL (Exc. Self Leveling Rear) Before VIN# -H1015470 & VIN# - H8000556	235053			KG4549			SM5103		SB102	

## SAAB 93 Series

1956-59	ALL		343030	KG4524	KG4006						
---------	-----	--	--------	--------	--------	--	--	--	--	--	--

## SAAB 95 Series











1959-66	ALL			KG4524							
---------	-----	--	--	--------	--	--	--	--	--	--	--

## SAAB 96 Series

1961-66	ALL			KG4524	KG4616						
---------	-----	--	--	--------	--------	--	--	--	--	--	--

<sup>12</sup> On models originally equipped with Nivomat self-leveling rear shocks, to install [KG4549] replace the original rear coil spring with Saab P/N 8960940  
<sup>77</sup> Replaces [341917], when stock is depleted

# Applications For Pass. Cars, Light Trucks, SUV's, & Vans

VEHICLE MAKE, MODEL & YEAR	<b>GR-2</b>	<b>Gas-a-Just</b>	<b>MonoMax</b> 56XXXX Series	STRUT & SHOCK	
MARQUE, MODELE ET	<b>Excel-G</b>		<b>AGX</b> 7XXXX Series	MOUNTS	BOOT KITS
ANNEE DU VEHICULE	 	 	 	 	 
LA MARCA EL MODELO & AÑO					

## SAAB 9-7X

2005-08	ALL							SM5395		SB108	
2005-07	Lower Spring Seat Insulator							SM5548			

## SAAB 99 Series

1979-80	ALL		343024	KG4524	KG5558						
1969-78	ALL		343219	KG4524	KG5517						

## SAAB GT Series & 896 Sport

1960-66	ALL			KG4524	KG4616						
1958-59	ALL		343030	KG4524	KG4006						

## SAAB Sonnett (97)

1968-74	ALL			KG4524	KG4616						
---------	-----	--	--	--------	--------	--	--	--	--	--	--

## SATURN Astra

2008-09	2 Door Hatchback		349043								
---------	------------------	--	--------	--	--	--	--	--	--	--	--

## SATURN Aura

2009	ALL	Right Hand	339051	349008					SM5471	SM5476	SB101
		Left Hand	339052	349008					SM5447	SM5476	SB101
2007-08	ALL (Exc. Green Line)	Right Hand	339051	349008					SM5471	SM5476	SB101
		Left Hand	339052	349008					SM5447	SM5476	SB101
	Green Line	Right Hand	339051						SM5471	SM5476	SB101
		Left Hand	339052						SM5447	SM5476	SB101

## SATURN Ion

2003-07	ALL (Exc. Red Line)	Right Hand	333461	343308					SM5483		SB101
		Left Hand	333462	343308					SM5483		SB101
	Upper Spring Seat Insulator w/ Bumper, w/ 16" wheels									SM5356	
	Upper Spring Seat Insulator w/ Bumper, w/o 16" wheels									SM5355	

## SATURN L Series

2003-05	ALL		NA	341907					SM5333	SM5332	SB103	SB107
2000-02	ALL	Right Hand	235701	341907					SM5333	SM5332	SB103	SB107
		Left Hand	235702	341907					SM5333	SM5332	SB103	SB107

## SATURN Outlook

2007-09	Strut / Shock Boot										SB101
---------	--------------------	--	--	--	--	--	--	--	--	--	-------

## SATURN Relay (AWD)

2005-06	ALL		335061						SM5143		SB127
	Upper Spring Seat Insulator								SM5467		
	Upper Spring Seat w/ Insulator								SM5470		
	Lower Spring Seat Insulator								SM5437		





## SATURN Relay (FWD)

2005-07	ALL (Exc. Self Leveling Rear)		335061	344338		KG54325			SM5143		SB127
	ALL w/ Self Leveling Rear		335061						SM5143		SB127
	Upper Spring Seat Insulator								SM5467	SM5549	
	Upper Spring Seat w/ Insulator								SM5470		
	Lower Spring Seat Insulator								SM5437	SM5549	

Notes de bas de Page 320 - Guia de notas al calce del catalogo Pg. 321

Bold part numbers indicate the most comparable KYB product to the original design & performance.  
(2) For vehicles with Electronic Susp., Leveling Control, and Air Suspensions refer to Appendix C.

# Applications For Pass. Cars, Light Trucks, SUV's, & Vans

VEHICLE MAKE, MODEL & YEAR		<b>GR-2</b>		<b>Gas-a-Just</b>		<b>MonoMax</b> 56XXXX Series		STRUT & SHOCK			
MARQUE, MODELE ET		<b>Excel-G</b>				<b>AGX</b> 7XXXXX Series		MOUNTS		BOOT KITS	
ANNEE DU VEHICULE											
LA MARCA EL MODELO & AÑO											
											

## SATURN S Series

1991-02	ALL		234055	234056					SM5078	SM5079	SB101	SB103
---------	-----	--	--------	--------	--	--	--	--	--------	--------	-------	-------

## SATURN Vue

2008-09	ALL (Exc. Green Line & Red Line Series)		345055		554353							
2005-07	ALL Spring Seat w/ Insulator	Right Hand Left Hand	339054 339053	343433 343433					SM5484 SM5484 SM5553		SB101 SB101	
2002-04	ALL Mounting Kit (Must Use with Spring Seat SM5553) Coil Spring Seat (Must Use with Mount SM5484)	Right Hand Left Hand	339054 339053	343433 343433					SM5484 SM5553		SB101 SB101	

## SCION xA

2004-06	ALL		333385	343426					SM5561		SB102	
---------	-----	--	--------	--------	--	--	--	--	--------	--	-------	--

## SCION xB

2008-10	ALL	Right Hand Left Hand	339204 339205									
2004-06	ALL Strut Mount		333385	343426					SM5562			

## SCION xD

2008-10	ALL	Right Hand Left Hand	339134 339135	348001 348001								
---------	-----	-------------------------	------------------	------------------	--	--	--	--	--	--	--	--

## SCION tC

2005-10	ALL	Right Hand Left Hand	339128 339129	341457 341457					SM5382 SM5382		SB108 SB108	
2005-06											SB102	

## SMART Fortwo (Canadian Vehicle)

2005-06	ALL			NA								
---------	-----	--	--	----	--	--	--	--	--	--	--	--

## STERLING 825 & 827S

1987-89	ALL (Exc. Nivomat Susp.)	Right Hand Left Hand		234044 234045								
---------	--------------------------	-------------------------	--	------------------	--	--	--	--	--	--	--	--

## SUBARU B9 Tribeca

2006-07	ALL	Right Hand Left Hand	335054 335055	341403 341403								
---------	-----	-------------------------	------------------	------------------	--	--	--	--	--	--	--	--

## SUBARU Baja











2004-06	ALL	Right Hand Left Hand							SM5361 SM5361	SM5214 SM5214	SB103 SB103	SB103 SB103
2003	ALL	Right Hand Left Hand	334447 334448	341276 341276					SM5361 SM5361	SM5214 SM5214	SB103 SB103	SB103 SB103

Notes de bas de Page 320 - Guia de notas al calce del catalogo Pg. 321  
 Bold part numbers indicate the most comparable KYB product to the original design & performance.  
 (22) For vehicles with Electronic Susp., Leveling Control, and Air Suspensions refer to Appendix C.

PASSENGER CARS / VOITURES / AUTOMOVILES  
 LIGHT TRUCKS / CAMIONNETTE / CAMIONES LIGEROS

HEAVY DUTY / MOTORHOME / SERVICE INTENSIF / AUTOCARS ET  
 AUTOCARAVANES / EQUIPOS PESADOS, AUTOBUSES, Y CASAS RODANTES

# Applications For Pass. Cars, Light Trucks, SUV's, & Vans

VEHICLE MAKE, MODEL & YEAR	<b>GR-2</b>	<b>Gas-a-Just</b>	<b>MonoMax</b> 56XXXX Series	STRUT & SHOCK	
MARQUE, MODELE ET	<b>Excel-G</b>		<b>AGX</b> 7XXXX Series	MOUNTS	BOOT KITS
ANNEE DU VEHICULE	 	 	 	 	 
LA MARCA EL MODELO & AÑO					

## SUBARU Brat

1981-87	ALL	234028	343056	KG4183A		SM5365		SB103	
---------	-----	--------	--------	---------	--	--------	--	-------	--

## SUBARU DL , GL (4WD)

1987-89	Sedan 2Dr. Sedan 4Dr. Wagon (Exc. Air Susp.)		341216 341065 341065			SM5364 SM5364			SB108 SB108 SB108
1986-89	Strut Mounting Kit ALL w/ 3-dr. (Exc. w/ Air Susp.)						SM5363		
1985-89	Strut Mounting Kit ALL w/ 4-dr. (Exc. w/ Air Susp.)						SM5362		
1985-87	Hatchback (Rear Shock w/o Spring Seat)	234028	343056	KG4183A		SM5364		SB105	
1985-86	Sedan (Exc. Air Susp.) Right Hand Sedan (Exc. Air Susp.) Left Hand Wagon (Exc. Air Susp.) Right Hand Wagon (Exc. Air Susp.) Left Hand	234046 234047 234046 234047	341065 341065 341065 341065			SM5364 SM5364		SB105 SB105 SB105 SB105	SB108 SB108 SB108 SB108
1980-84	ALL w/ Sealed Struts	234028	343056	KG4183A		SM5365		SB103	

## SUBARU Forester

2009-10	Strut / Shock Boot							SB103	
2006-08	ALL Right Hand ALL Left Hand	334468 334469	339149 339150			SM5361 SM5361		SB103 SB103	SB102 SB102
2004-05	ALL w/ Front Spring Seat Guards (Exc Self-Leveling Rear) Right Hand ALL w/ Front Spring Seat Guards (Exc Self-Leveling Rear) Left Hand ALL w/ Front Spring Seat Guards and Self-Leveling Rear Left Hand ALL w/ Front Spring Seat Guards and Self-Leveling Rear Right Hand	334370 334371 334371 334370	334344 334345			SM5361 SM5361 SM5361 SM5361	SM5422 SM5422 SM5422	SB103 SB103 SB103 SB103	SB102 SB102 SB102 SB102
2003	ALL (Exc. Self Leveling Rear) Right Hand ALL (Exc. Self Leveling Rear) Left Hand	334342 334343	334344 334345			SM5361 SM5361	SM5422 SM5422	SB103 SB103	SB102 SB102
1998-02	ALL (Exc. Self Leveling Rear) Right Hand ALL (Exc. Self Leveling Rear) Left Hand ALL w/ Self Leveling Rear Right Hand ALL w/ Self Leveling Rear Left Hand Strut Mount, AWD only Right Hand Strut Mount, AWD only Left Hand	334189 334190 334189 334190	334191 334192			SM5361 SM5361 SM5361 SM5361	SM5245 SM5244	SB103 SB103 SB103 SB103	SB101 SB101

## SUBARU DL , GL (FWD)

1986-89	Strut Mounting Kit ALL w/ 3-dr. (Exc. w/ Air Susp.)						SM5363		
1985-89	Sedan Right Hand Sedan Left Hand Wagon Right Hand Wagon Left Hand Hatchback (Rear Shock w/o Spring Seat) Strut Mounting Kit ALL w/ 4-dr. (Exc. w/ Air Susp.)	233022 233023 233022 233023 233024	341063 341063 341216 341216 343056	KG4183A		SM5364	SM5362	SB105 SB105 SB105 SB105 SB105	SB108 SB108 SB108 SB108
1982-84	ALL w/ Sealed Struts	233024	343056	KG4183A				SB103	
1980-83	ALL w/ Serviceable Struts	363027	343056	KG4183A				SB103	

## SUBARU Impreza (AWD) (Exc.Outback Model)













2008-10	ALL (Exc. WRX STI) Right Hand ALL (Exc. WRX STI) Left Hand	339171 <sup>68</sup> 339172 <sup>68</sup>	341487 <sup>68</sup> 341487 <sup>68</sup>					SB103 SB103	SB107 SB107
---------	---	--	--	--	--	--	--	----------------	----------------

<sup>68</sup> New Part Number; Available 3rd Quarter 2011

Notes de bas de Page 320 - Guia de notas al calce del catalogo Pg. 321

Bold part numbers indicate the most comparable KYB product to the original design & performance.  
(22) For vehicles with Electronic Susp., Leveling Control, and Air Suspensions refer to Appendix C.

# Applications For Pass. Cars, Light Trucks, SUV's, & Vans

VEHICLE MAKE, MODEL & YEAR	  	STRUT & SHOCK		BOOT KITS	
MARQUE, MODELE ET		MOUNTS			
ANNEE DU VEHICULE					
LA MARCA EL MODELO & AÑO					
	 	 	 	 	 

## SUBARU Impreza (AWD) (Exc.Outback Model) (continued)

2007	Station Wagon	Right Hand Left Hand		334356 334357					SM5361 SM5361	SM5422 SM5422	SB103 SB103	
2005-07	Sedan	Right Hand Left Hand	334470 334471	334358 334359							SB103 SB103	
2005-06	Station Wagon	Right Hand Left Hand	339121 339122	334356 334357					SM5361 SM5361	SM5422 SM5422	SB103 SB103	
2004	Sedan	Right Hand Left Hand	334460 334461	334358 334359					SM5361 SM5361	SM5422 SM5422	SB103 SB103	
	Station Wagon	Right Hand Left Hand	334462 334463	334356 334357					SM5361 SM5361	SM5422 SM5422	SB103 SB103	
2002-03	Sedan	Right Hand Left Hand	334304 334305	334306 334307			734034 734035	734036 <sup>10</sup> 734037 <sup>10</sup>	SM5361 SM5361	SM5245 SM5244	SB103 SB103	SB102 SB102
	Station Wagon	Right Hand Left Hand	334300 334301	334302 334303					SM5361 SM5361	SM5245 SM5244	SB103 SB103	SB102 SB102
1993-01	ALL (Exc. ABS)	Right Hand Left Hand	235065 <sup>85</sup> 235066 <sup>85</sup>	235069 <sup>87</sup> 235070 <sup>88</sup>			734006 734007	733010 733011	SM5361 SM5361	SM5243 SM5243	SB103 SB103	SB102 SB102
	ALL w/ ABS	Right Hand Left Hand	334255 334256	235069 <sup>87</sup> 235070 <sup>88</sup>			734006 734007	733010 733011	SM5361 SM5361	SM5243 SM5243	SB103 SB103	SB102 SB102

## SUBARU Impreza (FWD)

1993-96	FWD ALL (Exc. ABS)	Right Hand Left Hand	235065 <sup>85</sup> 235066 <sup>85</sup>	235073 235074			734006 734007		SM5361 SM5361		SB103 SB103	SB102 SB102
	FWD ALL w/ ABS	Right Hand Left Hand	334255 334256	235073 235074			734006 734007		SM5361 SM5361		SB103 SB103	SB102 SB102

## SUBARU Impreza Outback

2008-10	ALL	Right Hand Left Hand	339171 <sup>68</sup> 339172 <sup>68</sup>	341487 <sup>68</sup> 341487 <sup>68</sup>							SB103 SB103	SB107 SB107
2005-07	ALL	Right Hand Left Hand	339121 339122	334356 334357					SM5361 SM5361	SM5422 SM5422	SB103 SB103	SB102 SB102
2004	ALL	Right Hand Left Hand	334462 334463	334356 334357					SM5361 SM5361	SM5422 SM5422	SB103 SB103	SB102 SB102
2002-03	ALL	Right Hand Left Hand	334300 334301	334302 334303					SM5361 SM5361	SM5245 SM5244	SB103 SB103	SB102 SB102
1995-01	ALL (Exc. ABS)	Right Hand Left Hand	235065 <sup>85</sup> 235066 <sup>85</sup>	334109 334110			734006 734007	733010 733011	SM5361 SM5361	SM5243 SM5243	SB103 SB103	SB102 SB102
	ALL w/ ABS	Right Hand Left Hand	334255 334256	334109 334110			734006 734007	733010 733011	SM5361 SM5361	SM5243 SM5243	SB103 SB103	SB102 SB102

## SUBARU Justy

1989-94	Strut Mount w/ Bearing								SM5368			
---------	------------------------	--	--	--	--	--	--	--	--------	--	--	--

## SUBARU Legacy (AWD) (Exc. Outback Model)

2010	Strut / Shock Boot										SB103	
2009	ALL (Exc. GT Spec B)	Right Hand Left Hand	339096 339097	341353 341353						SM5214 SM5214	SB103 SB103	
2005-08	ALL (Exc. GT Spec B)	Right Hand Left Hand	339096 339097	341353 341353						SM5214 SM5214	SB103 SB103	SB101 SB101
2003-04	ALL	Right Hand Left Hand	334445 334446	341275 341275					SM5361 SM5361	SM5214 SM5214	SB103 SB103	SB101 SB101
2000-02	ALL	Right Hand Left Hand	334273 334274	341275 341275					SM5361 SM5361	SM5214 SM5214	SB103 SB103	SB101 SB101

<sup>10</sup> See the special instruction sheet packed with the AGX strut. To install and adjust the rear AGX struts on Subaru WRX, the rear seat cushions need to be removed and reinstalled per Factory specifications.

<sup>68</sup> New Part Number; Available 3rd Quarter 2011













<sup>85</sup> When [235065] stock is depleted, use [334111]

<sup>85</sup> When [235066] stock is depleted, use [334112]

<sup>87</sup> When [235069] stock is depleted, use [334109]

<sup>88</sup> When [235070] stock is depleted, use [334110]

# Applications For Pass. Cars, Light Trucks, SUV's, & Vans

VEHICLE MAKE, MODEL & YEAR	  	STRUT & SHOCK		BOOT KITS	
MARQUE, MODELE ET		MOUNTS			
ANNEE DU VEHICULE					
LA MARCA EL MODELO & AÑO					
	 	 	 	 	 

## SUBARU Legacy (AWD) (Exc. Outback Model) (continued)

1999	30th Anniversary	Right Hand	339151	335020					SM5361	SM5245	SB103	SB102
		Left Hand	339152	335021					SM5361	SM5244	SB103	SB102
	ALL (Exc. Air Susp., GT & 30th Anniversary)											
		Right Hand	334111	334115					SM5361	SM5245	SB103	SB102
		Left Hand	334112	334116					SM5361	SM5244	SB103	SB102
	GT Model	Right Hand	334253	334115					SM5361	SM5245	SB103	SB102
		Left Hand	334254	334116					SM5361	SM5244	SB103	SB102
1995-98	ALL (Exc. Air Susp.)	Right Hand	334111	334115					SM5361	SM5245	SB103	SB102
		Left Hand	334112	334116					SM5361	SM5244	SB103	SB102
1992-94	ALL (Exc. Air Susp.)	Right Hand	235065 <sup>85</sup>	235069 <sup>87</sup>			734006	733010	SM5361	SM5243	SB101	SB102
		Left Hand	235066 <sup>85</sup>	235070 <sup>88</sup>			734007	733011	SM5361	SM5243	SB101	SB102
1990-91	ALL (Exc. Air Susp.)	Right Hand	235063	235067					SM5361		SB101	SB102
		Left Hand	235064	235068					SM5361		SB101	SB102

## SUBARU Legacy (FWD)

1995-98	ALL (Exc. Air Susp.)	Right Hand	334111	334164					SM5361	SM5246	SB103	SB102
		Left Hand	334112	334165					SM5361	SM5247	SB103	SB102
1992-94	ALL (Exc. Air Susp.)	Right Hand	235065 <sup>85</sup>	235073			734006		SM5361		SB101	SB102
		Left Hand	235066 <sup>85</sup>	235074			734007		SM5361		SB101	SB102
1990-91	ALL	Right Hand	235063	235071					SM5361		SB101	SB102
		Left Hand	235064	235072					SM5361		SB101	SB102

## SUBARU Legacy Outback, Outback

2010	Strut / Shock Boot										SB103	
2009	ALL	Right Hand	339098	341443						SM5214	SB103	
		Left Hand	339099	341443						SM5214	SB103	
2005-08	ALL	Right Hand	339098	341443						SM5214	SB103	SB101
		Left Hand	339099	341443						SM5214	SB103	SB101
6/02-04	ALL	Right Hand	334447	341276					SM5361	SM5214	SB103	SB101
		Left Hand	334448	341276					SM5361	SM5214	SB103	SB101
2000-5/02	ALL	Right Hand	334275	341276					SM5361	SM5214	SB103	SB101
		Left Hand	334276	341276					SM5361	SM5214	SB103	SB101
1999	ALL	Right Hand	339151	335020					SM5361	SM5245	SB103	SB101
		Left Hand	339152	335021					SM5361	SM5244	SB103	SB101
1996-98	ALL	Right Hand	235632	335020					SM5361	SM5245	SB103	SB101
		Left Hand	235633	335021					SM5361	SM5244	SB103	SB101
1995	ALL	Right Hand	334111	334115					SM5361			
		Left Hand	334112	334116					SM5361			

## SUBARU Loyale (4WD)

1990-94	Sedan			341065					SM5364	SM5362		SB108
1990-92	Wagon (Exc. Air Susp.)			341065								SB108

## SUBARU Loyale (FWD)

1990-93	Sedan	Right Hand	233022	341063						SM5362	SB105	SB108
		Left Hand	233023	341063						SM5362	SB105	SB108
	Wagon	Right Hand	233022	341216						SM5362	SB105	SB108
		Left Hand	233023	341216						SM5362	SB105	SB108











<sup>85</sup> When [235065] stock is depleted, use [334111]

<sup>86</sup> When [235066] stock is depleted, use [334112]

<sup>87</sup> When [235069] stock is depleted, use [334109]

<sup>88</sup> When [235070] stock is depleted, use [334110]

# Applications For Pass. Cars, Light Trucks, SUV's, & Vans

VEHICLE MAKE, MODEL & YEAR		<b>GR-2</b> <i>Excel-G</i>		<b>Gas-a-Just</b>		<b>MonoMax</b> 56XXXX Series <b>AGX</b> 7XXXXX Series		STRUT & SHOCK MOUNTS		BOOT KITS	
MARQUE, MODELE ET ANNEE DU VEHICULE		 		 		 		 		 	
LA MARCA EL MODELO & AÑO											

## SUBARU SVX

1992-97	ALL	NA	NA								
---------	-----	----	----	--	--	--	--	--	--	--	--

## SUBARU Tribeca

2008-10	ALL	Right Hand Left Hand	335054 335055	341403 341403							
---------	-----	-------------------------	------------------	------------------	--	--	--	--	--	--	--

## SUBARU WRX

2004-07	Sedan (Exc. WRX-Sti)	Right Hand	334470	334358					SM5361	SM5422	SB101	SB102
		Left Hand	334471	334359					SM5361	SM5422	SB101	SB102
	Station Wagon	Right Hand	339121	334356					SM5361	SM5422	SB101	SB102
		Left Hand	339122	334357					SM5361	SM5422	SB101	SB102
2002-03	Sedan (Exc. WRX-Sti)	Right Hand	334304	334306			734034	734036 <sup>10</sup>	SM5361	SM5245	SB101	SB102
		Left Hand	334305	334307			734035	734037 <sup>10</sup>	SM5361	SM5244	SB101	SB102
	Station Wagon	Right Hand	334300	334302					SM5361	SM5245	SB101	SB102
		Left Hand	334301	334303					SM5361	SM5244	SB101	SB102

## SUBARU XT

1985-91	Strut Mounting Kit 4WD (Exc. Air Susp.) 2WD (Exc. XT6 & Air Susp.) XT6 (Exc. Air Susp.)	Right Hand	234029	341063					SM5363			
		Left Hand	234030	341063					SM5364	SM5362	SB108	SB105
				341063					SM5364	SM5362	SB108	SB105

## SUZUKI Aerio

2004-07	ALL	Right Hand	333431	333356					SM5489		SB101	SB101
		Left Hand	333432	333357					SM5489		SB101	SB101
2002-03	ALL (Exc. SX Wagon)	Right Hand	333354	333356					SM5489		SB101	SB101
		Left Hand	333355	333357					SM5489		SB101	SB101

## SUZUKI Esteem

2000-02	ALL	Right Hand	333312	333215					SM5487	SM5489	SB101	SB101
		Left Hand	333313	333216					SM5487	SM5489	SB101	SB101
1995-99	ALL	Right Hand	333312	333215					SM5487	SM5488	SB101	SB101
		Left Hand	333313	333216					SM5487	SM5488	SB101	SB101

## SUZUKI Forenza

2004-08	Sedan	Right Hand	339142	333481							SB101	
		Left Hand	339143	333482							SB101	

## SUZUKI Forsa (Canadian Vehicle)

1987-88	ALL	Right Hand	232019	341075								
		Left Hand	232020	341075								

## SUZUKI Grand Vitara













2006-09	ALL	Right Hand	334464	343435							SB105	
		Left Hand	334465	343435							SB105	
2002-05	ALL	Right Hand	334195	343247		KG4745A			SM5366			
		Left Hand	334196	343247		KG4745A			SM5366			
2001	ALL (Exc. XL-7)	Right Hand	334195	343247		KG4745A			SM5366			
		Left Hand	334196	343247		KG4745A			SM5366			
1999-00	ALL	Right Hand	334195	343247		KG4745A			SM5366			
		Left Hand	334196	343247		KG4745A			SM5366			

<sup>10</sup> See the special instruction sheet packed with the AGX strut. To install and adjust the rear AGX struts on Subaru WRX, the rear seat cushions need to be removed and reinstalled per Factory specifications.





# Applications For Pass. Cars, Light Trucks, SUV's, & Vans

VEHICLE MAKE, MODEL & YEAR	  	STRUT & SHOCK		BOOT KITS	
MARQUE, MODELE ET		MOUNTS			
ANNEE DU VEHICULE					
LA MARCA EL MODELO & AÑO					
	 	 	 	 	 

## TOYOTA 4-Runner (continued)

1996-97	ALL Shock Mount (4WD) Upper Spring Seat Insulator (2WD)			KG9025	KG54317	564002	565002	SM5184 SM5413			
1990-95	ALL	344202		KG5474	KG5475	565058	565059				
1986-89	ALL	344202	344428	KG5474	KG5462	565058	565052				
1984-85	ALL	344054	344428	KG5437	KG5462	565042	565052				

## TOYOTA 4-Runner - Lift Replacement Shocks

1990-95	ALL Lift = 0-2"					565084	565059				
1986-89	ALL Lift = 0-2"					565084	565085				
1984-85	ALL Lift = 0-2"						565085				

## TOYOTA 4-Runner - Steering Stabilizer

1986-95	OEM Replacement Cylinder	SS10351									
---------	--------------------------	---------	--	--	--	--	--	--	--	--	--

## TOYOTA Avalon

2009-10	Limited & XLS	Right Hand	339179	339043							
		Left Hand	339180	339044							
	XL Sport Package	Right Hand	339183	339043							
		Left Hand	339184	339044							
2008	XL (Exc. Sport Package)	Right Hand		339043							
		Left Hand		339044							
2008	ALL (Exc. Touring)	Right Hand	339179	339043							
		Left Hand	339180	339044							
	Touring	Right Hand	339183	339043							
1/2006-07		Left Hand	339184	339044							
	ALL (Exc. Touring)	Right Hand	339179	339043							
		Left Hand	339180	339185							
2005-01/06	Touring	Right Hand	339183	339043							
		Left Hand	339184	339185							
	ALL (Exc. Touring)	Right Hand	339177	334388							
2005-01/06		Left Hand	339178	334389							
	Touring	Right Hand	339181	334388							
		Left Hand	339182	334389							
2004-10	Upper Spring Seat w/ Insulator							SM5485			
2004	ALL	Right Hand	339136	339138				SM5179	SM5175	SB101	SB101
		Left Hand	339137	339139				SM5180	SM5175	SB101	SB101
1997-03	ALL	Right Hand	334245	334133				SM5179	SM5175	SB101	SB101
		Left Hand	334246	334134				SM5180	SM5175	SB101	SB101
	Upper Spring Seat w/ Insulator Lower Spring Seat Insulator							SM5485 SM5441	SM5469		
1995-96	ALL	Right Hand	334170	334133				SM5174	SM5133	SB101	SB101
		Left Hand	334171	334134				SM5174	SM5133	SB101	SB101
	Upper Spring Seat w/ Insulator Lower Spring Seat Insulator							SM5485 SM5441	SM5469		
	Upper Spring Seat Insulator							SM5468			

## TOYOTA Camry (also see STRUT-PLUS)

2010	Hybrid	Right Hand	339023	339043							SB101
		Left Hand	339024	339044							SB101
2007-10	Upper Spring Seat w/ Insulator							SM5485			
2007-09	ALL (Exc. SE)	Right Hand	339023	339043							SB101
		Left Hand	339024	339044							SB101

Notes de bas de Page 320 - Guia de notas al calce del catalogo Pg. 321

Bold part numbers indicate the most comparable KYB product to the original design & performance.

(22) For vehicles with Electronic Susp., Leveling Control, and Air Suspensions refer to Appendix C.



# Applications For Pass. Cars, Light Trucks, SUV's, & Vans

VEHICLE MAKE, MODEL & YEAR	<b>GR-2</b> <i>Excel-G</i>	<b>Gas-a-Just</b>	<b>MonoMax</b> 56XXXX Series <b>AGX</b> 7XXXXX Series	STRUT & SHOCK  MOUNTS	BOOT KITS
MARQUE, MODELE ET ANNEE DU VEHICULE					
LA MARCA EL MODELO & AÑO					

## TOYOTA Celica (continued)

1990-93	ALL (Exc. All-Trac)	Right Hand Left Hand	365075 365075	235037 235038					SM5086 SM5086	SM5087 SM5087	SB103 SB103	SB101 SB101
1990-92	All-Trac		365075						SM5086	SM5087	SB103	SB101
1988-89	ALL (Exc. All-Trac)	Right Hand	365064	235028			765015		SM5086	SM5069	SB103	SB117
		Left Hand	365064	235029			765015		SM5086	SM5069	SB103	SB117
1986-87	ALL (Exc. GTS)	Right Hand	365058	235017					SM5086	SM5069	SB103	SB117
		Left Hand	365058	235018					SM5086	SM5069	SB103	SB117
1982-85	GTS	Right Hand	365058	235028					SM5086	SM5069	SB103	SB117
		Left Hand	365058	235029					SM5086	SM5069	SB103	SB117
1982-85	ALL (Exc. GTS)		365005	343039			KG5552		SM5370		SB101	
	GTS w/ I.R.S.		365005	343042			KG5561		SM5370		SB101	
	GTS w/ Solid Rear Axle		365005	343039			KG5552		SM5370		SB101	
1978-81	ALL		365005	343039			KG5552				SB103	
10/75-77	ALL		365005	343149					SM5370		SB101	
6/73-9/75	ALL			343149							SB103	
1971-6/73	ALL			343149							SB103	

## TOYOTA Corolla (Exc. FX Series & All Trac)

2009-10	ALL (Exc. XRS)	Right Hand	339114 <sup>70</sup>	341448 <sup>70</sup>						SM5382	SB102	
		Left Hand	339115 <sup>70</sup>	341448 <sup>70</sup>						SM5382	SB102	
		XRS Right Hand	339114 <sup>70</sup>	340018 <sup>70</sup>						SM5382	SB102	
		XRS Left Hand	339115 <sup>70</sup>	340018 <sup>70</sup>						SM5382	SB102	
2003-08	ALL	Right Hand	334450	344612					SM5215	SM5382	SB102	SB108
		Left Hand	334451	344612					SM5215	SM5382	SB102	SB108
1993-02	ALL (Exc. Performance & S)	Right Hand	333236	234059					SM5049	SM5075	SB103	SB117
		Left Hand	333237	234060					SM5049	SM5074	SB103	SB117
		Performance, Incl. S model	234057	234059					SM5049	SM5075	SB103	SB117
		Left Hand	234058	234060					SM5049	SM5074	SB103	SB117
1988-92	ALL w/ FWD (Exc. GTS) w/ Sealed Strut	Right Hand	234035	234031					SM5104	SM5075	SB103	SB102
		Left Hand	234036	234032					SM5104	SM5074	SB103	SB102
	ALL w/ FWD (Exc. GTS) w/ Serviceable Strut	Right Hand	363060	234031					SM5104	SM5075	SB103	SB102
		Left Hand	363060	234032					SM5104	SM5074	SB103	SB102
	GTS Model	Right Hand		234031					SM5075	SM5075	SB102	SB102
	GTS Model (Frt. Cartridges)	Left Hand		234032					SM5074	SM5074	SB102	SB102
Lower Spring Seat Insulator		365064						SM5049		SB103		
1986-87	RWD w/ Power Steering	Right Hand	365076	343149			KG4762		SM5020		SB101	
		Left Hand	365076	343149			KG4762		SM5021			
	RWD w/o PowerSteering	Right Hand	365076	343149			KG4762		SM5022		SB101	
		Left Hand	365076	343149			KG4762		SM5023			
1984-87	ALL w/ FWD (Exc. Diesel) w/ Sealed Strut	Right Hand	234024	232028					SM5019	SM5069		SB102
		Left Hand	234025	232029					SM5019	SM5069		SB102
	ALL w/ FWD (Exc. Diesel) w/ Serviceable Strut	Right Hand	363039	232028					SM5019	SM5069		SB102
		Left Hand	363039	232029					SM5019	SM5069		SB102
	FWD Diesel	Right Hand	365041	232028					SM5019	SM5069	SB101	SB102
		Left Hand	365041	232029					SM5019	SM5069	SB101	SB102
1984-85	RWD w/ Power Steering	Right Hand	365015	343149			KG4762		SM5020		SB101	
		Left Hand	365015	343149			KG4762		SM5021			





<sup>70</sup> New Part Number, Available 2nd Quarter 2011

Notes de bas de Page 320 - Guia de notas al calce del catalogo Pg. 321

Bold part numbers indicate the most comparable KYB product to the original design & performance.

(22) For vehicles with Electronic Susp., Leveling Control, and Air Suspensions refer to Appendix C.

# Applications For Pass. Cars, Light Trucks, SUV's, & Vans

VEHICLE MAKE, MODEL & YEAR	  		
MARQUE, MODELE ET ANNEE DU VEHICULE			
LA MARCA EL MODELO & AÑO			

## TOYOTA Corolla (Exc. FX Series & All Trac) (continued)

1984-85	RWD w/o PowerSteering	Right Hand Left Hand	365015 365015	343149 343149		KG4762 KG4762			SM5022 SM5023		SB101	
1982-83	Sedan, Coupe & Hatchback	Right Hand Left Hand	365015 365015	343149 343149		KG4762 KG4762			SM5022 SM5023		SB101 SB101	
1980-83	1800 Model Station Wagon		365015								SB101	
1980-81	Sedan, Coupe & Hatchback		365015	343149		KG4762			SM5371		SB101	
1975-79	1200 Model 1600 Model (Exc. Station Wagon) 1600 Model Station Wagon SR-5 Model		365015 365015 365015	343147 343147 343039 343147					SM5369 SM5369 SM5369 SM5369		SB101 SB101 SB101 SB101	
1973-74	SR-5			343140							SB103	
1967-4/70	ALL (Exc. Station Wagon)			343140								
5/70-74	ALL (Exc. SW & SR-5) Station Wagon Shock (Sleeve) Adapter Kit			343140 343143 <sup>5</sup> KIT105					SM5371 SM5371		SB103 SB103	

## TOYOTA Corolla FX Series (Exc.4WD)

1987-89	FX16, FX16 GTS		365041	232030					SM5019	SM5069	SB101	SB117
1987-88	FX	Right Hand Left Hand	234024 234025	232028 232029					SM5019 SM5019	SM5069 SM5069	SB101 SB101	SB117 SB117

## TOYOTA Corona

1979-83	ALL		365016	343039					SM5370		SB103	
8/73-78	ALL (Exc. Station Wagon) Station Wagon		343127 343127	343149 344044	KG4611A KG4611A	KG4012						
2/70-7/73	ALL		343127	343147	KG4611A							
1964-1/70	ALL (Exc. Station Wagon) Station Wagon		343127 343127	343147 344044	KG4611A KG4611A	KG4012						

## TOYOTA Corona Mark II

1972-76	ALL (Exc. Station Wagon) Station Wagon		343127 343127	343147 344044	KG4611A KG4611A	KG4012						
1969-71	ALL		343127		KG4611A							

## TOYOTA Cressida (Exc. Electronically-Adjustable Suspension)

1989-92	ALL		365076	341111					SM5374	SM5373	SB103	SB107
1985-88	Strut Mount ALL (Exc. TEMS)								SM5374			
1983-88	Sedan		365076	343042		KG5551					SB103	
1983-87	Station Wagon		365076	343039		KG5552					SB103	
1981-82	Sedan Station Wagon		365017 365017	343039		KG4766 KG5552			SM5065 SM5065		SB103 SB103	
1978-80	Sedan Station Wagon		365016 365016	343039		KG4766 KG5552			SM5065 SM5065		SB103 SB103	











## TOYOTA Echo

2003-05	Strut Mount								SM5561			
2000-05	ALL		333258	343295							SB102	
2000-02	Strut Mount w/ Bearing w/ 23.4mm opening / cover Strut Mount w/ Bearing w/ 26mm opening / cover								SM5473 SM5472			

<sup>5</sup> Use Kit #105

Notes de bas de Page 320 - Guia de notas al calce del catalogo Pg. 321  
 Bold part numbers indicate the most comparable KYB product to the original design & performance.  
 (22) For vehicles with Electronic Susp., Leveling Control, and Air Suspensions refer to Appendix C.

# Applications For Pass. Cars, Light Trucks, SUV's, & Vans

VEHICLE MAKE, MODEL & YEAR	<b>GR-2</b>	<b>Gas-a-Just</b>	<b>MonoMax</b> 56XXXX Series	STRUT & SHOCK	
MARQUE, MODELE ET	<b>Excel-G</b>		<b>AGX</b> 7XXXX Series	MOUNTS	BOOT KITS
ANNEE DU VEHICULE	 	 	 	 	 
LA MARCA EL MODELO & AÑO					

## TOYOTA FJ Cruiser

2007-09	ALL	341340	344410							
---------	-----	--------	--------	--	--	--	--	--	--	--

## TOYOTA Highlander (AWD)

2008-09	Strut / Shock Boot Lower Spring Seat Insulator							SM5469		SB104	
2004-07	ALL Right Hand Left Hand Upper Spring Seat w/ Insulator Lower Spring Seat Insulator	334399 334400	334394 334395					SM5423 SM5423 SM5485	SM5491 SM5492	SB102 SB102	SB104 SB104
2001-03	ALL Right Hand Left Hand Upper Spring Seat w/ Insulator Lower Spring Seat Insulator	334399 334400	334263 334264					SM5423 SM5423 SM5485	SM5175 SM5175	SB102 SB102	SB101 SB101

## TOYOTA Highlander (FWD)

2008-09	Strut / Shock Boot Lower Spring Seat Insulator							SM5469		SB104	
2004-07	ALL Right Hand Left Hand Upper Spring Seat w/ Insulator Lower Spring Seat Insulator	334399 <sup>64</sup> 334400 <sup>65</sup>	334384 334385					SM5423 SM5423 SM5485	SM5491 SM5492	SB102 SB102	SB104 SB104
2001-03	ALL Right Hand Left Hand Upper Spring Seat w/ Insulator Lower Spring Seat Insulator	334399 334400	334428 334429					SM5423 SM5423 SM5485	SM5175 SM5175	SB102 SB102	SB101 SB101

## TOYOTA Land Cruiser

1/98-06	HJ95 SW (Torsion Bar Front Susp.)	345022	345023							
1991-1/98	FJ80 SW (Coil Spring Front Susp.)			KG54300	KG54301	565026	565027			
1988-90	FJ60 SW		344428	KG5475	KG5462	565059	565052			
1985-87	FJ60 SW		344015	KG5475	KG4026	565059				
1981-84	FJ40 FJ60 SW	344426	344090 344015	KG5401 KG5475	KG5466 KG4026	565059				
1969-80	FJ40 FJ55 SW	344426	344090 344015	KG5401	KG5466 KG4026					

## TOYOTA Land Cruiser - Lift Replacement Shocks

1988-90	FJ60 SW Lift = 0-2"						565085			
---------	---------------------	--	--	--	--	--	--------	--	--	--

## TOYOTA MR2

1/90-95	ALL (Exc. Sealed Struts)	365064	365100			765015	765016	SM5161		SB103	SB103
1987-89	ALL (Exc. Sealed Struts)	363045	365061							SB103	SB103
1985-86	ALL (Exc. Sealed Struts)	363045	363046							SB103	SB103

## TOYOTA MR2 Spyder

2000-05	ALL Right Hand Left Hand	333320 333321	334310 334311							SB101 SB101	SB101 SB101
---------	--------------------------------	------------------	------------------	--	--	--	--	--	--	----------------	----------------

## TOYOTA Matrix (AWD)













2009-10	ALL w/ 2.4L Engine Right Hand Left Hand	339194 <sup>70</sup> 339195 <sup>70</sup>	340017 <sup>70</sup> 340017 <sup>70</sup>					SM5382 SM5382		SB102 SB102	SB108 SB108
---------	---	--	--	--	--	--	--	------------------	--	----------------	----------------

<sup>64</sup> Replaces [235904], when stock is depleted

<sup>65</sup> Replaces [235905], when stock is depleted

<sup>70</sup> New Part Number, Available 2nd Quarter 2011

# Applications For Pass. Cars, Light Trucks, SUV's, & Vans

VEHICLE MAKE, MODEL & YEAR		  	STRUT & SHOCK		BOOT KITS						
MARQUE, MODELE ET			MOUNTS								
ANNEE DU VEHICULE											
LA MARCA EL MODELO & AÑO											
											

## TOYOTA Matrix (AWD) (continued)

2003-06	ALL	Right Hand	235703	344613					SM5215	SM5382	SB102	SB108
		Left Hand	235704	344613					SM5215	SM5382	SB102	SB108

## TOYOTA Matrix (FWD)

2009-10	ALL w/ 1.8L Engine	Right Hand	339114 <sup>70</sup>	340018 <sup>70</sup>						SM5382	SB102	SB108
		Left Hand	339115 <sup>70</sup>	340018 <sup>70</sup>						SM5382	SB102	SB108
	ALL w/ 2.4L Engine	Right Hand	339194 <sup>70</sup>	340018 <sup>70</sup>						SM5382	SB102	SB108
		Left Hand	339195 <sup>70</sup>	340018 <sup>70</sup>						SM5382	SB102	SB108
2003-08	ALL	Right Hand	235703	344612					SM5215	SM5382	SB102	SB108
		Left Hand	235704	344612					SM5215	SM5382	SB102	SB108

## TOYOTA Paseo

8/95-97	ALL	Right Hand	333209	341191					SM5089	SM5163	SB103	SB108
		Left Hand	333210	341191					SM5089	SM5163	SB103	SB108
1992-7/95	ALL	Right Hand	234053	341125					SM5089	SM5088	SB103	SB108
		Left Hand	234054	341125					SM5089	SM5088	SB103	SB108

## TOYOTA Pickup (2WD) (Exc. T100, Tacoma)

1990-95	1 Ton		343209	344090	KG4752	KG5438	565030					
1985-95	ALL (Exc. Diesel & 1 Ton)		343209	344044	KG4752	KG4012	565030	565028				
1985-89	1 Ton		343209	344090	KG4752	KG5466	565030					
1984	ALL (Exc. Diesel)		343209	344044	KG4752	KG4012	565030	565028				
	ALL w/ Diesel			344044		KG4012		565028				
1982-83	ALL (Exc. Diesel)		343127	344044	KG4611A	KG5434						
	ALL w/ Diesel			344044		KG5434						
1979-81	ALL		343127	344055	KG4611A	KG5538						
1977-78	ALL		343127	344055	KG4611A	KG5538						
1970-76	ALL		343127		KG4611A							

## TOYOTA Pickup (4WD) (Exc. T100, Tacoma)

1986-95	ALL		344202	344428	KG5474	KG5462	565058	565052				
1984-85	ALL		344054	344428	KG5437	KG5462	565042	565052				
1979-83	ALL		344054	344045	KG5437	KG5438	565042					

## TOYOTA Pickup (4WD) (Exc. T100, Tacoma) - Steering Stabilizer

1986-95	OEM Replacement Cylinder		SS10351									
---------	--------------------------	--	---------	--	--	--	--	--	--	--	--	--

## TOYOTA Pickup (4WD) (Exc. T100, Tacoma) Lift Replacement Shocks

1986-95	ALL Lift = 0-2"						565084	565085				
1984-85	ALL Lift = 0-2"							565085				

## TOYOTA Previa

1991-97	ALL	Right Hand	235039	344431		KG5494			SM5090		SB101	
		Left Hand	235040	344431		KG5494			SM5090		SB101	

## TOYOTA Prius











2009	ALL	Right Hand	333388	341322								SB108
		Left Hand	333389	341322								SB108
2004-08	ALL	Right Hand	333388	341322					SM5215	SM5382		SB108
		Left Hand	333389	341322					SM5215	SM5382		SB108

<sup>70</sup> New Part Number, Available 2nd Quarter 2011

Notes de bas de Page 320 - Guia de notas al calce del catalogo Pg. 321

Bold part numbers indicate the most comparable KYB product to the original design & performance.  
(22) For vehicles with Electronic Susp., Leveling Control, and Air Suspensions refer to Appendix C.

# Applications For Pass. Cars, Light Trucks, SUV's, & Vans

VEHICLE MAKE, MODEL & YEAR		<b>GR-2</b> <i>Excel-G</i>		<b>Gas-a-Just</b>		<b>MonoMax</b> 56XXXX Series <b>AGX</b> 7XXXX Series		STRUT & SHOCK MOUNTS		BOOT KITS	
MARQUE, MODELE ET ANNEE DU VEHICULE		 		 		 		 		 	
LA MARCA EL MODELO & AÑO											

## TOYOTA Prius (continued)

2003-03	ALL	Right Hand Left Hand	333360 333361	341321 341321					SM5474 SM5474	SM5382 SM5382	SB101 SB101	SB108 SB108
---------	-----	-------------------------	------------------	------------------	--	--	--	--	------------------	------------------	----------------	----------------

## TOYOTA RAV4

2006-08	ALL	Right Hand Left Hand	339031 339032	349024 349024								
2001-05	ALL	Right Hand Left Hand	335040 335041	343272 343272		KG4738 KG4738			SM5162 SM5162		SB102 SB102	
1996-00	2 Door w/ 16" Wheels	Right Hand Left Hand	334241 334242	343313 343313					SM5162 SM5162		SB103 SB103	
	4 Door w/ 16" Wheels	Right Hand Left Hand	334251 334252	343314 343314					SM5162 SM5162		SB103 SB103	
	ALL w/o 16" wheels, w/ Sealed Struts	Right Hand Left Hand	334241 334242	343272 343272		KG4738 KG4738			SM5162 SM5162		SB103 SB103	
	1996-99	ALL w/ Serviceable Struts		365093	343272		KG4738			SM5162		SB103

## TOYOTA Sequoia

2003-07	ALL (Exc. Self Leveling Rear)		341466	344406					SM5442			
2001-02	ALL		341312 <sup>8</sup>	344358					SM5442			

## TOYOTA Sienna

2009-10	AWD	Right Hand Left Hand	339102 339103	344480 344480					SM5423 SM5423			
	FWD w/ 7 Passenger Seating	Right Hand Left Hand	339100 339101	344308 344308					SM5423 SM5423			
	FWD w/ 8 Passenger Seating	Right Hand Left Hand	339102 339103	344480 344480					SM5423 SM5423			
	7/05-08	AWD	Right Hand Left Hand	339102 339103	344480 344480				SM5423 SM5423			
7/05-08	FWD w/ 7 Passenger Seating	Right Hand Left Hand	339100 339101	344308 344308					SM5423 SM5423			
	FWD w/ 8 Passenger Seating	Right Hand Left Hand	339102 339103	344480 344480					SM5423 SM5423			
	2004-08	Upper Spring Seat w/ Insulator							SM5485			
2004-6/05	AWD	Right Hand Left Hand	334452 334453	344480 344480					SM5423 SM5423			
	FWD w/ 8 Passenger Seating	Right Hand Left Hand	334452 334453	344480 344480					SM5423 SM5423			
1/03-6/05	FWD w/ 7 Passenger Seating	Right Hand Left Hand	334430 334431	344308 344308								
1998-05	Lower Spring Seat Insulator								SM5441			
1998-12/02	ALL	Right Hand Left Hand	235624 235625	343149 343149		KG5522 KG5522			SM5179 SM5180		SB101 SB101	
	1998-03	Upper Spring Seat w/ Insulator							SM5485			

## TOYOTA Solara

7/06-08	ALL	Right Hand Left Hand	339192 <sup>70</sup> 339193 <sup>70</sup>	339214 <sup>70</sup> 339215 <sup>70</sup>					SM5423 SM5423		SB102 SB102	
	Upper Spring Seat w/ Insulator								SM5485			
2004-6/06	ALL	Right Hand Left Hand	334386 334387	334388 334389					SM5423 SM5423	SM5175 SM5175	SB102 SB102	SB101 SB101
	Upper Spring Seat w/ Insulator								SM5485			

<sup>70</sup> New Part Number, Available 2nd Quarter 2011

<sup>8</sup> When [341312] stock is depleted, use [341466]











Notes de bas de Page 320 - Guia de notas al calce del catalogo Pg. 321

Bold part numbers indicate the most comparable KYB product to the original design & performance.

(22) For vehicles with Electronic Susp., Leveling Control, and Air Suspensions refer to Appendix C.



# Applications For Pass. Cars, Light Trucks, SUV's, & Vans

VEHICLE MAKE, MODEL & YEAR	  	STRUT & SHOCK		BOOT KITS	
MARQUE, MODELE ET		MOUNTS			
ANNEE DU VEHICULE					
LA MARCA EL MODELO & AÑO					
	 	 	 	 	 

## TOYOTA Solara (continued)

1999-03	ALL	Right Hand Left Hand	334245 334246	334133 334134					SM5179 SM5180 SM5485 SM5441	SM5175 SM5175 SM5469	SB101 SB101	SB101 SB101
		Upper Spring Seat w/ Insulator Lower Spring Seat Insulator										

## TOYOTA Starlet

1981-84	ALL		363038		KG3765						SB103	
---------	-----	--	--------	--	--------	--	--	--	--	--	-------	--

## TOYOTA Supra

1994-98	ALL (Exc. Adjustable Susp.)				KG6800	KG6799	725001	725002		SM5186	SB101	SB104	
3/86-93	ALL (Exc. Adjustable Susp.) ALL (For Adapting TEMS to Non-TEMS Suspension)		341069 341069 <sup>c</sup>	341070 341070 <sup>c</sup>						SM5160 SM5160	SM5159 SM5159	SB101 SB101	SB107 SB107
1982-2/86	ALL		365076	343042		KG5561				SM5374		SB101	

## TOYOTA T100 (2WD)

1995-98	ALL w/ Extra Cab		343209	344090	KG4752	KG5466	565030					
1993-98	1 Ton ALL (Exc. Extra Cab & Exc. 1 Ton)		343209 343209	344090 344044	KG4752 KG4752	KG5438 KG5434	565030 565030					

## TOYOTA T100 (4WD)

1993-98	ALL		344202	343403	KG5474	KG54105	565058	565035				
---------	-----	--	--------	--------	--------	---------	--------	--------	--	--	--	--

## TOYOTA T100 (4WD) Lift Replacement Shocks

1993-98	ALL Lift = 0-2"						565084					
---------	-----------------	--	--	--	--	--	--------	--	--	--	--	--

## TOYOTA Tacoma (2WD)

2005-10	ALL (Exc. Off Road Susp. X-Runner)	Right Hand Left Hand	341458 341459	349011 349011		554351 554351						
	X-Runner PreRunner and Off-Road Package		NA 341340	349011 349010	551104	554351 554350						
1998-04	PreRunner and Off-Road Package			344428	KG9024	KG5462	564001	565052				
1999-04	ALL w/ Extended Cab (Exc. Pre-Runner)		343410	344448	553360	553361						
1995-98	ALL w/ Extended Cab (Exc. Pre-Runner)		343209	344055	KG4752	KG5538	565030	565065				
2003-04	ALL w/ Regular Cab (Exc. Pre-Runner)		343209	344447	KG4752	KG4161						
1995-02	ALL w/ Regular Cab (Exc. Pre-Runner & Off Road Package)		343209	344055	KG4752	KG5538	565030	565065				

## TOYOTA Tacoma (4WD)

2005-10	ALL		341340	349010	551104	554350						
1998-04	ALL w/ TRD Package			344428	KG9024	KG5462	564001	565052				
1995-04	ALL w/o TRD Package Upper Spring Seat Insulator			344428	KG9024	KG5462	564001	565052	SM5413			











## TOYOTA Tacoma - Lift Replacement Shocks

1998-02	2WD PreRunner & Off-Road Package Lift = 0-2"						565085					
1995-04	4WD Lift = 0-2"						565085					

<sup>c</sup> To convert from Electronic Susp - See Appendix C

Notes de bas de Page 320 - Guia de notas al calce del catalogo Pg. 321  
 Bold part numbers indicate the most comparable KYB product to the original design & performance.  
 (22) For vehicles with Electronic Susp., Leveling Control, and Air Suspensions refer to Appendix C.

# Applications For Pass. Cars, Light Trucks, SUV's, & Vans

VEHICLE MAKE, MODEL & YEAR	<b>GR-2</b>	<b>Gas-a-Just</b>	<b>MonoMax</b> 56XXXX Series	STRUT & SHOCK	
MARQUE, MODELE ET	<b>Excel-G</b>		<b>AGX</b> 7XXXX Series	MOUNTS	BOOT KITS
ANNEE DU VEHICULE	 	 	 	 	 
LA MARCA EL MODELO & AÑO					

## TOYOTA Tercel

1999	ALL	Right Hand Left Hand	333209 333210	341191 341191					SM5089 SM5089	SM5163 SM5163		
1995-98	ALL	Right Hand Left Hand	333209 333210	341191 341191					SM5089 SM5089	SM5163 SM5163		
1991-94	ALL	Right Hand Left Hand	234053 234054	341125 341125					SM5089 SM5089	SM5088 SM5088	SB103 SB103	SB108 SB108
1987-90	Sedan & Hatchback		363047		KG9129				SM5068	SM5088	SB103	SB107
1983-88	4WD Station Wagon		363037	343149	KG4762				SM5067		SB103	
1983-87	FWD Station Wagon	Right Hand Left Hand	363030 363030	232005 232006					SM5067 SM5067	SM5069 SM5069	SB103 SB103	SB101 SB101
1983-86	Hatchback	Right Hand Left Hand	363030 363030	232005 232006					SM5067 SM5067	SM5069 SM5069	SB103 SB103	SB101 SB101
1980-82	ALL		363063								SB103	

## TOYOTA Tundra (2WD)

2007-10	ALL w/o Off-Road Package		341480	349054	551125	554367						
2004-06	Double Cab		341440		551119	KG54335			SM5442			
2000-06	ALL w/o Double Cab & TRD				KG9026	KG54335			SM5442			

## TOYOTA Tundra (4WD)

2007-10	ALL w/o Off-Road Package		341480	349054	551125	554367						
2004-06	Double Cab		341440		551119	KG54336			SM5442			
2000-06	ALL w/o Double Cab & TRD TRD w/o Double Cab				KG9026 551119	KG54336 KG54336			SM5442 SM5442			

## TOYOTA Van

1987-89	4WD			343140		KG4644A						
1984-89	2WD w/ Rear Coil Springs 2WD w/ Rear Leaf Springs			344055	KG4652A KG4652A	KG5463 KG5538						

## TOYOTA Venza

2009-10	Strut / Shock Boot Lower Spring Seat Insulator									SM5469		SB104
---------	---	--	--	--	--	--	--	--	--	--------	--	-------

## TOYOTA Yaris

2007-10	ALL	Right Hand Left Hand	334472 334473	343442 343442								
2006	ALL	Right Hand Left Hand	334472 334473	343442 343442								

## TRIUMPH Spitfire, GT6, Herald, TR7, TR8

1976-83	TR7, TR8		363015			KG5550						
1969-73	GT6-Plus				KG9125							
1959-80	Spitfire, GT6 (Exc.Plus), Herald				KG9125	KG3198						

## U.S. POSTAL VEHICLE All Models











1999-03	Ford Chassis		341302	344269	KG54309	KG5490						
1995-00	GMC Chassis		344265	344041	KG5478	KG5451						
---	AM General Model FJ-8A AM General Model FJ-9 AM General Models DJ-5A,B,C,D		344426	344426	KG5401 KG5419 KG5401	KG5401 KG5426	565037					

Notes de bas de Page 320 - Guia de notas al calce del catalogo Pg. 321  
 Bold part numbers indicate the most comparable KYB product to the original design & performance.  
 (22) For vehicles with Electronic Susp., Leveling Control, and Air Suspensions refer to Appendix C.

PASSENGER CARS / VOITURES / AUTOMOVILES  
 LIGHT TRUCKS / CAMIONNETTE / CAMIONES LIGEROS

HEAVY DUTY / MOTORHOME / SERVICE INTENSIF / AUTOCARS ET  
 AUTOCARAVANES / EQUIPOS PESADOS, AUTOBUSES, Y CASAS RODANTES

# Applications For Pass. Cars, Light Trucks, SUV's, & Vans

VEHICLE MAKE, MODEL & YEAR	<b>GR-2</b>	<b>Gas-a-Just</b>	<b>MonoMax</b> 56XXXX Series	STRUT & SHOCK	
MARQUE, MODELE ET	<b>Excel-G</b>		<b>AGX</b> 7XXXXX Series	MOUNTS	BOOT KITS
ANNEE DU VEHICULE	 	 	 	 	 
LA MARCA EL MODELO & AÑO					

## U.S. POSTAL VEHICLE All Models (continued)

---	LLV Model by Grumman	344040	344041	KG5450	KG5451	565046	565047				
-----	----------------------	--------	--------	--------	--------	--------	--------	--	--	--	--

## UTILIMASTER All Models

---	Aeromate	235901			KG4524			SM5003		SB103	
-----	----------	--------	--	--	--------	--	--	--------	--	-------	--

## VOLKSWAGEN CC

2009-10	ALL	335808	344459					SM5567			
---------	-----	--------	--------	--	--	--	--	--------	--	--	--

## VOLKSWAGEN Beetle (New)

1998-10	ALL	334812	343280			734033	743029	SM5181	SM5182	SB123	SB125
---------	-----	--------	--------	--	--	--------	--------	--------	--------	-------	-------

## VOLKSWAGEN Cabrio

1995-02	ALL Upper Spring Seat	235614	343191		KG9130			SM5378	SM5070 SM5132	SB109	SB115
---------	--------------------------	--------	--------	--	--------	--	--	--------	------------------	-------	-------

## VOLKSWAGEN Cabriolet

1990-93	ALL w/ Sealed Struts		341007		KG9105 <sup>2</sup>			SM5011	SM5070	SB109	SB115
1985-93	ALL (Exc. Sealed Struts)	361005 <sup>15</sup>	341007		KG9105 <sup>2</sup>			SM5011	SM5070	SB109	SB115

## VOLKSWAGEN Corrado (Exc.V6)

1992-95	VR6 Strut Mounting Kit							SM5378	SM5070		
1990-95	Lower Spring Seat								SM5558		
1990-94	ALL w/ Sealed Struts ALL (Exc. Sealed Struts) Upper Spring Seat	235614 364014 <sup>15</sup>	343191 343191		KG9130 KG9130			SM5012 SM5012	SM5070 SM5070 SM5132	SB109 SB109	SB115 SB115

## VOLKSWAGEN Dasher

1974-81	ALL	364001			KG5532			SM5011		SB103	
---------	-----	--------	--	--	--------	--	--	--------	--	-------	--

## VOLKSWAGEN Eos

2010	Boot Kit Strut Mount Kit							SM5567		SB101	SB125
2008-10	Standard Susp. From VIN 1F-8-015001	335808									
2007-10	ALL		349022					SM5567		SB101	SB125

## VOLKSWAGEN Eurovan

1993-03	ALL	344261									
---------	-----	--------	--	--	--	--	--	--	--	--	--

## VOLKSWAGEN Fox

1987-93	Sedan Station Wagon	365008 365008						SM5024 SM5024	SM5376 SM5376	SB101 SB101	
---------	------------------------	------------------	--	--	--	--	--	------------------	------------------	----------------	--

## VOLKSWAGEN GTI

2006-10	ALL	335808	344459					SM5567		SB101	SB125
---------	-----	--------	--------	--	--	--	--	--------	--	-------	-------

## VOLKSWAGEN City Golf (Canadian Vehicle)

2007-09	ALL	334812	343280				743029	SM5181	SM5182	SB123	
---------	-----	--------	--------	--	--	--	--------	--------	--------	-------	--

<sup>15</sup> Reuse original internal-threaded strut body nut on certain applications; or replace with VW P/N 823412047.













<sup>2</sup> The KYB replacement unit comes with a new dustcover/ bumper assembly.

Notes de bas de Page 320 - Guia de notas al calce del catalogo Pg. 321

Bold part numbers indicate the most comparable KYB product to the original design & performance.

(22) For vehicles with Electronic Susp., Leveling Control, and Air Suspensions refer to Appendix C.

# Applications For Pass. Cars, Light Trucks, SUV's, & Vans

VEHICLE MAKE, MODEL & YEAR	  	STRUT & SHOCK		BOOT KITS	
MARQUE, MODELE ET		MOUNTS			
ANNEE DU VEHICULE					
LA MARCA EL MODELO & AÑO					
	 	 	 	 	 

## VOLKSWAGEN City Jetta (Canadian Vehicle)

2007-09	ALL	334812	343280				743029	SM5181	SM5182	SB123	
---------	-----	--------	--------	--	--	--	--------	--------	--------	-------	--

## VOLKSWAGEN Golf

2010	ALL w/ 22mm Strut Piston Rod, 50mm Outer Shell	334834 <sup>68</sup>	344459								
	ALL w/ 25mm Strut Piston Rod, 55mm Outer Shell	335808	344459								
2005-06	Golf IV	334812	343280			734033	743029	SM5181	SM5182	SB123	
2004	ALL (Exc. R32 Performance Package)	334812	343280			734033	743029	SM5181	SM5182	SB123	
1999-05	Strut Boot (Exc. R32 Performance Package) Shock Mount (Exc. R32 Performance Package) (IV)								SM5182		SB125
1999-03	Golf IV	334812	343280			734033	743029	SM5181	SM5182	SB123	
1997-99	Strut Mounting Kit 4 cyl. Gas (III)							SM5378			
1996-98	Strut Mounting Kit 4 cyl. Diesel (III)							SM5378			
1995-99	Strut Mounting Kit 6 cyl. Gas (III)							SM5378			
1993-99	Golf III (Exc. VR6) Golf III w/ VR6 Upper Spring Seat (III) Lower Spring Seat (III)	235614 235614	343191 343191		KG9130 KG9130			SM5012	SM5070 SM5070 SM5132 SM5558	SB109 SB109	SB115 SB115
1990-92	ALL w/ Sealed Struts	235614	343191		KG9130			SM5012	SM5070	SB109	SB115
1985-92	ALL (Exc. Sealed Struts) Upper Spring Seat Lower Spring Seat	364014 <sup>15</sup>	343191		KG9130			SM5012	SM5070 SM5132 SM5558	SB109	SB115

## VOLKSWAGEN Jetta

2006-10	Jetta (V)	335808	344459					SM5567		SB101	SB125
2001-05	Jetta (IV)	334812	343280			734033	743029	SM5181	SM5182	SB123	SB125
1999-00	Jetta (IV)	334812	343280			734033	743029	SM5181	SM5182	SB123	SB125
1997-99	Strut Mounting Kit 4 cyl. Gas (III)							SM5378			
1996-99	Jetta (III) Upper Spring Seat (III) Lower Spring Seat (III)	235614	343191		KG9130				SM5070 SM5132 SM5558	SB109	SB115
1995-99	Strut Mounting Kit 6 cyl. Gas (III)							SM5378			
1990-95	ALL	235614	343191		KG9130			SM5012	SM5070	SB109	SB115
1985-95	Upper Spring Seat Lower Spring Seat								SM5132 SM5558		
1985-89	ALL	364014 <sup>15</sup>	343191		KG9130			SM5012	SM5070	SB109	SB115
1980-84	ALL	361005 <sup>15</sup>	341007		KG9105 <sup>2</sup>			SM5011	SM5070	SB109	SB113

## VOLKSWAGEN Passat











2006-10	ALL ALL (Exc. Sport Susp.)	335808	344459					SM5567		SB101	
2001-05	AWD Strut Mounting Kit from VIN #3B1300001 Strut Mounting Kit from VIN #3B1300001 (FWD)	341273						SM5380	SM5379		
2000-05	Sedan (FWD) From VIN # 3B-Y-200001	341273	343281					SM5380	SM5379	SB122	SB124
1998-01	Shock Mount To VIN #3B1300001 (FWD)								SM5237		

<sup>15</sup> Reuse original internal-threaded strut body nut on certain applications; or replace with VW P/N 823412047.

<sup>2</sup> The KYB replacement unit comes with a new dustcover/ bumper assembly.

<sup>68</sup> New Part Number; Available 3rd Quarter 2011

# Applications For Pass. Cars, Light Trucks, SUV's, & Vans

VEHICLE MAKE, MODEL & YEAR	<b>GR-2</b>	<b>Gas-a-Just</b>	<b>MonoMax</b> 56XXXX Series	STRUT & SHOCK	
MARQUE, MODELE ET	<b>Excel-G</b>		<b>AGX</b> 7XXXXX Series	MOUNTS	BOOT KITS
ANNEE DU VEHICULE	 	 	 	 	 
LA MARCA EL MODELO & AÑO					

## VOLKSWAGEN Passat (continued)

1998-00	Sedan (FWD) To VIN # 3B-Y-200000	341207	343281					SM5236	SM5237	SB122	SB124
1993-97	Strut Mounting Kit VR6							SM5378	SM5197		
1990-97	ALL (Exc. V6 Models) (Exc. Sealed Strut)	365070	341124					SM5012	SM5197	SB109	SB115

## VOLKSWAGEN Quantum, Quantum Synchro

1986-88	Quantum Synchro	365008						SM5034	SM5377	SB101	
4/83-88	ALL (Exc. Quantum Synchro)	365008	341123					SM5034	SM5377	SB101	SB107
1982-3/83	ALL	365008	341122					SM5034	SM5377	SB101	SB107

## VOLKSWAGEN R32

2008	ALL		344459								
------	-----	--	--------	--	--	--	--	--	--	--	--

## VOLKSWAGEN Rabbit

2006-09	ALL	335808	344459					SM5567		SB101	SB125
1975-84	ALL	361005 <sup>15</sup>	341007		KG9105 <sup>2</sup>			SM5011	SM5070	SB109	SB113

## VOLKSWAGEN Rabbit (Truck)

1980-84	ALL	361005 <sup>15</sup>			KG5449			SM5011		SB102	
---------	-----	----------------------	--	--	--------	--	--	--------	--	-------	--

## VOLKSWAGEN Routan

2009-10	Strut Boot									SB101	
---------	------------	--	--	--	--	--	--	--	--	-------	--

## VOLKSWAGEN Scirocco, Scirocco 16V

1975-90	ALL	361005 <sup>15</sup>	341007		KG9105 <sup>2</sup>			SM5011	SM5070	SB109	SB113
---------	-----	----------------------	--------	--	---------------------	--	--	--------	--------	-------	-------

## VOLKSWAGEN Thing

1973-75	ALL Shock (Sleeve) Adapter Kit	343143 <sup>3</sup> KIT103	343144	KG4520 <sup>3</sup> KIT103	KG5529						
---------	-----------------------------------	-------------------------------	--------	-------------------------------	--------	--	--	--	--	--	--

## VOLKSWAGEN Tiguan

2009-10	Strut Mount Kit							SM5567			
---------	-----------------	--	--	--	--	--	--	--------	--	--	--

## VOLKSWAGEN Type 1 - Beetle (Original), SuperBeetle, Karmann Ghia

1973-80	Super Beetle From Chassis No. 1,333,003,657	363002	343144		KG5529					SB101	
1971-73	Super Beetle Thru Chassis No. 1,333,003,656	363012	343144		KG5529					SB101	
1967-77	ALL (Exc. Super Beetle)	343143	343144	KG4520	KG5529					SB101	
1966	1200 Model ALL (Exc. 1200 Model)	343144 343143	343144 343144	KG4521 KG4520	KG5529 KG5529						
1952-65	ALL	343144	343144	KG4521	KG5529						

## VOLKSWAGEN Type 2 - Van, Vanagon

1986-91	Synchro		344082		KG5459		565050				
1980-91	ALL (Exc. Synchro)	345006			KG5557						
1955-67	ALL	343144	343144	KG4521	KG5529						
1968-79	ALL Shock (Sleeve) Adapter Kit	343144	344045 <sup>7</sup> KIT107	KG4521	KG5530						

<sup>15</sup> Reuse original internal-threaded strut body nut on certain applications; or replace with VW P/N 823412047.

<sup>2</sup> The KYB replacement unit comes with a new dustcover/ bumper assembly.

<sup>3</sup> Use Kit #103

<sup>7</sup> Use Kit #107

# Applications For Pass. Cars, Light Trucks, SUV's, & Vans

VEHICLE MAKE, MODEL & YEAR		<b>GR-2</b>		<b>Gas-a-Just</b>		<b>MonoMax</b> 56XXXX Series		STRUT & SHOCK			
MARQUE, MODELE ET		<b>Excel-G</b>				<b>AGX</b> 7XXXX Series		MOUNTS		BOOT KITS	
ANNEE DU VEHICULE											
LA MARCA EL MODELO & AÑO											

## VOLKSWAGEN Type 3 - Squareback, Fastback

1966-73	ALL	343144	343144	KG4521	KG5529						
---------	-----	--------	--------	--------	--------	--	--	--	--	--	--

## VOLVO 120, 130, 220 Series

1961-70	120 Station Wagon ALL (Exc. 120 Station Wagon)	343137 343137	343030 343219	KG5514 KG5514	KG4006 KG5517						
---------	---	------------------	------------------	------------------	------------------	--	--	--	--	--	--

## VOLVO 140, 160 Series

1975	164 Model	343127	343010	KG4550	KG5553						
1967-74	ALL	343127		KG4550	KG5535						

## VOLVO 1800S, E, ES Series

1961-73	ALL	343137	343219	KG5514	KG5517						
---------	-----	--------	--------	--------	--------	--	--	--	--	--	--

## VOLVO 240, 260 Series

1979-93	ALL (Exc. w/ High Pressure) High Pressure Gas Strut Equipped	365006 365006 <sup>13</sup>	343010 343010		KG5553 KG5553			SM5050 SM5050		SB101	
1979-81	265 Model (Exc. Nivomat Rear Susp.)	365006	343010		KG5553			SM5050		SB101	
1975-78	ALL	365006	343010		KG5553			SM5050		SB101	

## VOLVO 740 Series

1985-92	ALL (Exc. Nivomat Susp.)	365053	344270		KG5565 <sup>14</sup>			SM5092		SB111	
1983-84	ALL (Exc. Nivomat Susp.)		344270		KG5565 <sup>14</sup>			SM5092		SB111	

## VOLVO 760 Series

1988-93	Sedan	365053						SM5092		SB111	
1985-92	Station Wagon (Exc. Nivomat Susp.)	365053	344270		KG5565 <sup>14</sup>			SM5092		SB111	
1985-87	Sedan (Exc. Nivomat Susp.)	365053	344270		KG5565 <sup>14</sup>			SM5092		SB111	
1983-84	ALL (Exc. Nivomat Susp.)		344270		KG5565 <sup>14</sup>			SM5092		SB111	

## VOLVO 780 Series

1988-91	ALL	365053						SM5092		SB111	
---------	-----	--------	--	--	--	--	--	--------	--	-------	--

## VOLVO 850 Series

1993-97	FWD (Exc. Self Leveling Rear Susp.) FWD w/ Self Leveling Rear Spring Seat	SR1001 <sup>31</sup> SR1001 <sup>31</sup>			KG5747			SM5165 SM5165 SM5351	SM5220	SB103 SB103	
---------	---	--	--	--	--------	--	--	----------------------------	--------	----------------	--

## VOLVO 940 Series

1995	ALL (Exc. Nivomat Susp.)	365053	344270		KG5565 <sup>14</sup>			SM5092		SB111	
1991-95	ALL w/ Nivomat Rear Susp.	365053						SM5092		SB111	
1991-94	ALL (Exc. Nivomat Rear Susp.)	365053	344270		KG5565			SM5092		SB111	

## VOLVO 960 Series

1991-9/94	ALL (Exc. Nivomat Rear Susp.) ALL w/ Nivomat Rear Susp.	365053 365053	344270		KG5565			SM5092 SM5092		SB111 SB111	
-----------	--	------------------	--------	--	--------	--	--	------------------	--	----------------	--

## VOLVO C30







2008-10	ALL										
		Right Hand Left Hand	334842 334843	343419 343419							

<sup>13</sup> If originally equipped with High Pressure Gas Cartridges; These parts are required to install [365006]: 1) PN 1229423-7 (from Volvo) installed under the cartridge, 2) Strut Boot # [SB 101] installed on the cartridge piston rod.

<sup>14</sup> On models with Nivomat self-leveling rear shocks, to install [KG5565] replace the original coil spring

<sup>31</sup> When [SR1001] stock is depleted, use [334678]

# Applications For Pass. Cars, Light Trucks, SUV's, & Vans

VEHICLE MAKE, MODEL & YEAR		<b>GR-2</b>		<b>Gas-a-Just</b>		<b>MonoMax</b> 56XXXX Series		STRUT & SHOCK			
MARQUE, MODELE ET		<b>Excel-G</b>				<b>AGX</b> 7XXXXX Series		MOUNTS		BOOT KITS	
ANNEE DU VEHICULE		 		 		 		 		 	
LA MARCA EL MODELO & AÑO											

## VOLVO C70 (Exc. Self-Leveling Susp.)

1998-04	ALL Spring Seat	SR1001 <sup>31</sup>		KG5747				SM5165 SM5351	SM5220	SB103	
---------	--------------------	----------------------	--	--------	--	--	--	------------------	--------	-------	--

## VOLVO Coupe

1991	ALL	365053						SM5092		SB102	
------	-----	--------	--	--	--	--	--	--------	--	-------	--

## VOLVO PV-444, PV-544 Series

1945-66	Sedans		343039		KG5552						
---------	--------	--	--------	--	--------	--	--	--	--	--	--

## VOLVO S40

2005-10	FWD	Right Hand Left Hand	334842 334843	343419 343419							
2004	ALL w/ 2.4L & 2.5L	Right Hand Left Hand	334842 334843	343419 343419							
2001-04	ALL 1.9L	Right Hand Left Hand	334438 334439	341217 341217							
2000	Upper Mount Kit First Generation Strut Mount Bearing First Generation Upper Spring Seat Insulator First Generation							SM5128	SM5091 SM5439		

## VOLVO S60

2001-09	Strut Mount w/ Bearing Exc. AWD & Adj. Susp. Upper Spring Seat							SM5475 SM5351	SM5493		
2001-08	2.5T AWD FWD		334611 334611		551918						
2001-07	FWD									SB103	

## VOLVO S70

1998-00	FWD Upper Spring Seat	SR1001 <sup>31</sup>		KG5747				SM5165 SM5351	SM5220	SB103	
---------	--------------------------	----------------------	--	--------	--	--	--	------------------	--------	-------	--

## VOLVO S80

2001-06	Strut Mount w/ Bearing (from chassis # 153440)							SM5475			
1999-06	ALL (Exc. Nivomat Rear Susp.) FWD (Exc. Adj. Susp.) from Chassis 13723 Upper Spring Seat		334611		551918			SM5351	SM5493	SB103	
1999-01	Strut Mount To Chassis # 153439							SM5165			

## VOLVO S90

1997-98	Strut Mount w/ Bearing							SM5092			
---------	------------------------	--	--	--	--	--	--	--------	--	--	--

## VOLVO V40













2001-04	ALL	Right Hand Left Hand	334438 334439	341217 341217							
---------	-----	-------------------------	------------------	------------------	--	--	--	--	--	--	--

## VOLVO V50

2009-10	2.4i	Right Hand Left Hand	334842 334843	343419 343419							
---------	------	-------------------------	------------------	------------------	--	--	--	--	--	--	--

<sup>31</sup> When [SR1001] stock is depleted, use [334678]

# Applications For Pass. Cars, Light Trucks, SUV's, & Vans

VEHICLE MAKE, MODEL & YEAR	  	STRUT & SHOCK		BOOT KITS	
MARQUE, MODELE ET		MOUNTS			
ANNEE DU VEHICULE					
LA MARCA EL MODELO & AÑO	 	 	 	 	 

## VOLVO V50 (continued)

2005-08	FWD	Right Hand	334842	343419							
		Left Hand	334843	343419							

## VOLVO V70

2002-07	AWD (Exc. X/C)		334611								
2001-07	FWD Strut Mount w/ Bearing Upper Spring Seat		334611			551918			SM5475 SM5351		SB103
1998-00	FWD (Exc. Nivomat Rear Susp.) Upper Spring Seat		SR1001 <sup>31</sup>			KG5747			SM5165 SM5351	SM5220	SB103

## VOLVO V90

1997-98	Strut Mount w/ Bearing								SM5092		
---------	------------------------	--	--	--	--	--	--	--	--------	--	--

## VOLVO XC90

2003-05	ALL Upper Spring Seat		NA	NA					SM5475 SM5351		SB101
---------	--------------------------	--	----	----	--	--	--	--	------------------	--	-------

<sup>31</sup> When [SR1001] stock is depleted, use [334678]



# APPENDIX A

**SUBJECT:** MacPherson strut cartridge replacement on GM-10 series ("W"-car) vehicles. This includes 1988 and later Pontiac Grand Prix, Oldsmobile Cutlass and Buick Regal, 1989 and later Chevrolet Lumina.

**PROBLEM:** A MacPherson strut spring compressor is not required to replace the MacPherson struts on these vehicles. The strut cartridge is removed and replaced through the body shock tower. Special tools are required.

## W-CAR TOOL SUPPLIERS

COMPANY	PHONE
Branick #GMW-594	1-800-437-4394
GP Tool # GP2013-8 w/ #GP2013-12	1-800-223-0555
Schley #88400	1-714-693-7666
Specialty #88802 w/ # 88805	1-800-525-6505



## CAUTION:

Do not service the strut unless the vehicle is on the floor. All 4 tires must be on the floor and facing straight ahead, otherwise the coil spring can fly free.

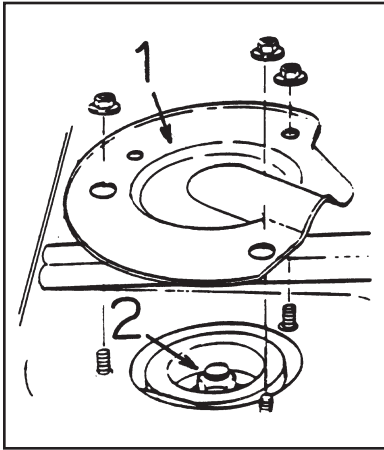

1. Remove the three nuts and the strut mount cover (Item 1). Remove the strut piston rod nut (Item 2).

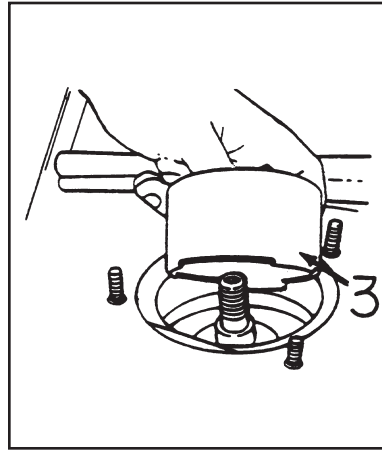

2. Remove the strut mount bushing (Item 3) by prying with a suitable tool.

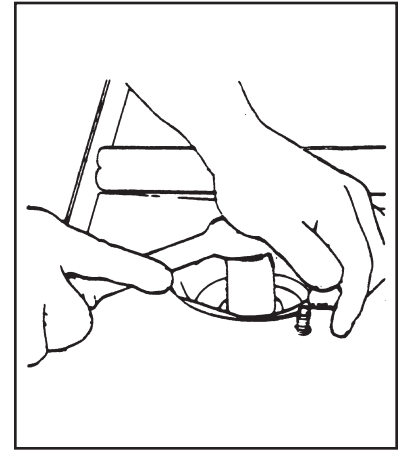

3. Remove the jounce bumper retaining plate using a special tool. Rotate tool counterclockwise to remove.

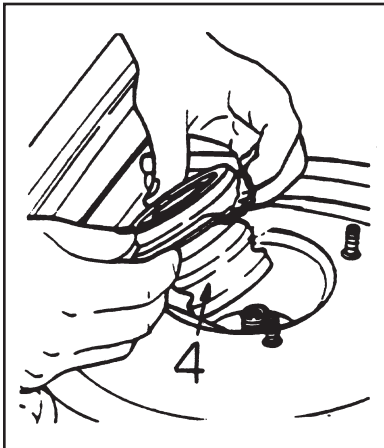

4. Remove the jounce bumper (Item 4).

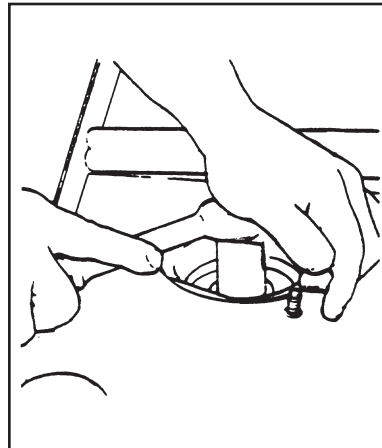

5. Remove the strut cartridge retaining nut using a special tool.

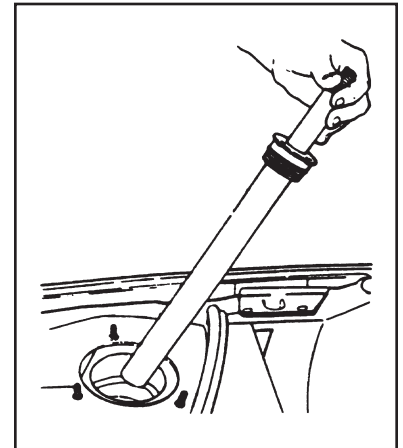

6. Remove the strut cartridge and replace with a new unit. Replace all components in reverse order of disassembly. Torque cartridge retaining nut and all nuts and bolts to manufacturer's specifications.

## APPENDIX B

### SELF LEVELING SYSTEM ELECTRONIC COMPRESSOR DEACTIVATION PROCEDURE FOR GM MODELS

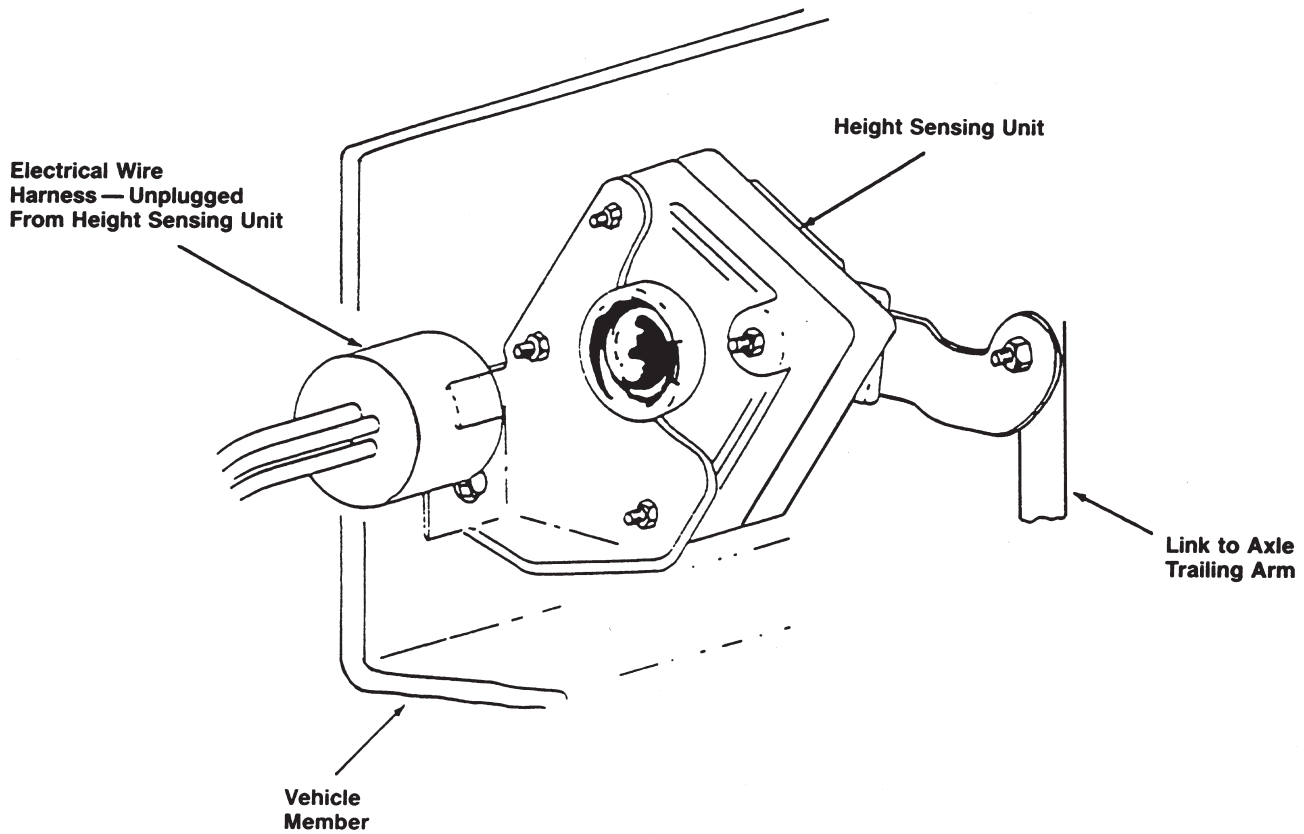

When installing conventional shock absorbers on GM models equipped with self-leveling rear suspension that uses an electronic compressor, the following procedure should be used:

- 1) Locate height sensing unit on under body of vehicle approximately above the rear axle. Locate a small link connected to the rear axle trailing arm. The upper end of this link will be connected to the electronic height sensing unit.
- 2) Unplug electrical wire harness from the height sensing unit. System is now deactivated.
- 3) Cover exposed electrical connector with tape or other suitable material and secure to underside of vehicle.
- 4) It is Not necessary to disconnect link to axle trailing arm.

# APPENDIX C

## ELECTRONIC SUSPENSIONS AIR SUSPENSIONS AND ELECTRONIC LEVEL CONTROLS

Occasionally a customer will inquire if their vehicle's electronic suspension, air suspension or rear electronic level control can be replaced with standard components. The following chart will assist you in determining answers to these inquiries.

### VEHICLE/SYSTEM

#### **GM, FORD, CHRYSLER FULLSIZE AND INTERMEDIATES**

Electronic level control ELC; known also as air shocks, air struts.

In most cases, standard shocks and struts can be installed if the ELC System is disarmed. Refer to Appendix B for one such disarming procedure.

---

#### **LINCOLN CONTINENTAL, MITSUBISHI GALANT, SUBARU**

Air suspension struts; i.e.,

These systems cannot be substituted for without extensive vehicle modification. KYB does not recommend removal.

---

#### **DODGE STEALTH 1991-96 with ECS (Electronic Controlled Suspension)**

1. Remove front struts and rear shock activators.
  2. Unplug control module behind right rear trim panel.
  3. Remove and install struts and shocks per instruction sheet supplied with units.
  4. Use the following units: 335013 Front, 341184 Rear (2 W/D), 341185 Rear (4 W/D).
- 

#### **CHEVROLET CORVETTE 1990-94 — with ERC (Electronic Ride Control)**

1. Remove shock actuators.
  2. Unplug ERC module located in rear cargo area.
  3. Remove & install shocks per instruction sheet supplied with units.
  4. Use the following units: KG5570 Front, KG5571 Rear.
- 

#### **FORD PROBE GT 1989-92 — with PRC (Programmed Ride Control)**

1. Remove strut actuators.
  2. Unplug PRC module located under the passenger seat.
  3. Remove & install struts per instruction sheet supplied with units.
  4. Use the following units: 235046 Right Front, 235047 Left Front, 235606 Rear.
- 

#### **FORD THUNDERBIRD SUPER COUPE 1989-96 with PRC (Programmed Ride Control)**

This system cannot be substituted without extensive vehicle modification. KYB Does Not Recommend Removal.

---

#### **FORD THUNDERBIRD TURBO COUPE 1987-88 with PRC (Programmed Ride Control)**

1. Remove strut and shock actuators.
  2. Unplug PRC module located in the trunk behind rear seat.
  3. Remove & install struts and shocks per instruction sheet supplied with units.
  4. Use the following units: 235008 Front, KG5556 Rear.
- 

#### **MAZDA MX6 GT 1988-92 — with AAS (Auto Adjust Suspension)**

1. Remove strut actuators.
  2. Unplug AAS module located in the trunk.
  3. Remove & install struts per instruction sheet supplied with units.
  4. Use the following units: 235046 Right Front, 235047 Left Front, 235606 Rear.
- 

#### **MAZDA RX7 TURBO 1989-92 & MAZDA RX7 GXL 1986-88 with AAS (Auto Adjust Suspension)**

1. Remove strut and shock actuators.
  2. Unplug AAS module located in the trunk.
  3. Remove and install struts & shocks per instruction sheet supplied with units.
  4. Use the following units: 235012 Right Front, 235013 Left Front, KG9132 Rear.
- 

#### **MAZDA 323 1986-89 — with ASA (Adjustable Shock Absorber)**

1. Remove strut actuators.
  2. Unplug control switch connector behind the dash.
  3. Remove & install struts per instruction sheet supplied with units.
  4. Use the following units: 234008 Right Front, 234009 Left Front, 232011 Right Rear, 232012 Left Rear.
  5. NOTE: The front upper mount must be replaced with a standard OE upper mount.
- 

#### **MAZDA 626 1988-92 with AAS (Auto Adjust Suspension)**

1. Remove strut actuators.
  2. Unplug AAS module located in the trunk.
  3. Remove & install shocks per instruction sheet supplied with units.
  4. Use the following units: 235046 Right Front, 235047 Left Front, 235606 Rear.
-

---

**MAZDA 626 1983-87 — with AAS (Auto Adjust Suspension)**

1. Remove strut actuators.
  2. Unplug AAS module located in the trunk.
  3. Remove & install struts per instruction sheet supplied with units.
  4. Use the following units: 233007 Right Front, 233008 Left Front, 234050 Rear.
- 

**MERCURY COUGAR XR7 1987-88 with PRC (Programmed Ride Control)**

1. Remove strut and shock actuators.
  2. Unplug PRC module located in the trunk behind rear seat.
  3. Remove & install struts and shocks per instruction sheet supplied with units.
  4. Use the following units: 235008 Front, KG5556 Rear.
- 

**MERCURY COUGAR XR7 1989-96 with PRC (Programmed Ride Control)**

This system cannot be substituted without extensive vehicle modification. KYB Does Not Recommend Removal.

---

**MITSUBISHI 3000 GT 1991-99 with ECS (Electronic Controlled Suspension)**

1. Remove front struts and rear shock activators.
  2. Unplug control module behind right rear trim panel.
  3. Remove and install struts and shocks per instruction sheet supplied with units.
  4. Use the following units: 335013 Front, 341184 Rear (2 W/D), 341185 Rear (4 W/D).
- 

**MITSUBISHI MONTERO 1992-96 with VSA (Variable Shock Absorbers)**

1. Remove shock activators.
  2. Unplug control module behind left rear trim panel.
  3. Remove and install shocks per instruction sheet supplied with units.
  4. Use the following units: KG54302 Front, KG54303 Rear.
- 

**NISSAN 300ZX 1984-89 with ECVSA (Electronically Controlled Variable Shock Absorber)**

1. Remove strut and shock actuators.
  2. Unplug ECVSA control module per Kit 108A instruction.
  3. Remove & install cartridges and shocks per instruction sheet supplied with units and Kit 108A.
  4. Use the following units: 365056 Front, KG5787A Rear.
  5. NOTE: Conversion Kit 108A (1 req.) necessary to convert entire vehicle. The original rear shock bumpers are not reusable.
- 

**NISSAN 300ZX 1990-95 with ECVSA (Electronically Controlled Variable Shock Absorber)**

1. Remove shock actuators.
  2. Unplug the ECVSA control module.
  3. Remove & install shocks per instruction sheet supplied with units.
  4. Fire/drill open round hole ( $\frac{1}{2}$ " i.d.) in front shock upper insulator.
  5. Fire/drill open ( $\frac{7}{16}$ " i.d.) the rear shock upper mount spacer.
  6. Use the following units: 341149 Right Front 341150 Left Front, 341151 Rear.
- 

**NISSAN MAXIMA 1989-94 with Nissan Sonar Suspension II**

1. Remove strut actuators.
  2. Unplug NSS module located in the console.
  3. Remove and install struts & shocks per instruction sheet supplied with units.
  4. Use the following units: 235051 Right Front, 235052 Left Front, 365079 Rear.
- 

**NISSAN MAXIMA 1985 with ECVSA (Electronically Controlled Variable Shock Absorber)**

1. Remove the strut actuators.
  2. Unplug ECVSA module located in the trunk.
  3. Remove & install struts per instruction sheet supplied with units.
  4. Replace the front strut mounts with KYB #SM5065 and the front upper spring seats, thrust seats, and strut tower covers with Nissan P/N's: 54040-05E00, 54043-01E00, and 54380-05E00. Two each of these 4 P/N's are required.
  5. Use the following units: 235030 Right Front, 235031 Left Front, and 365080 Rear.
- 

**NISSAN MAXIMA 1986-88 with ECVSA (Electronically Controlled Variable Shock Absorber)**

1. Remove the strut actuators.
  2. Unplug ECVSA module located in the trunk.
  3. Remove & install struts per instruction sheet supplied with the units.
  4. Replace the front strut mounts with KYB #SM5065 and the front upper spring seats, thrust seats, and strut tower covers with Nissan P/N's: 54040-05E00, 54043-01E00, and 54380-05E00. Two each of these 4 P/N's are required.
  5. Use the following units: 235019 Right Front, 235020 Left Front, and 365080 Rear.
- 

**NISSAN PATHFINDER 1987-95 with ASA (Adjustable Shock Absorber)**

1. Remove shock actuators.
  2. Unplug control switch located in console.
  3. Remove & install shocks per instruction sheet supplied with units.
  4. Use the following units: KG5476 Front, KG5438 Rear.
- 

**TOYOTA CRESSIDA 1986-88 with TEMS (Toyota Electronic Modulated Suspension)**

1. Remove shock actuators.
  2. Unplug TEMS module located behind the right rear trim panel.
  3. Remove & install shocks per instruction sheet supplied with units.
  4. Use the following units: N/A Front, 343042 Rear.
- 

**TOYOTA SUPRA MAR. 1986-91 with TEMS (Toyota Electronic Modulated Suspension)**

1. Remove shock actuators.
  2. Unplug TEMS module located under the dash.
  3. Remove & install shocks per instruction sheet supplied with units.
  4. Use the following units: 341069 Front, 341070 Rear.
-